



City of Hamilton
GENERAL ISSUES COMMITTEE

Meeting #: 20-002
Date: January 17, 2020
Time: 9:30 a.m.
Location: Council Chambers, Hamilton City Hall
71 Main Street West

Stephanie Paparella, Legislative Coordinator (905) 546-2424 ext. 3993

	Pages
1. APPROVAL OF AGENDA	
2. DECLARATIONS OF INTEREST	
3. APPROVAL OF MINUTES OF PREVIOUS MEETING	
4. COMMUNICATIONS	
4.1 Correspondence from David Richter respecting the City of Hamilton 2020 Operating Budget	3
5. CONSENT ITEMS	
6. STAFF PRESENTATIONS	
6.1 2020 Budget Overview (FCS20001) (City Wide)	4
6.2 Planning & Economic Development Department 2020 Operating Budget Presentation (to be distributed)	249
7. DISCUSSION ITEMS	
8. MOTIONS	
9. NOTICES OF MOTION	
10. GENERAL INFORMATION / OTHER BUSINESS	
11. PRIVATE & CONFIDENTIAL	

12. ADJOURNMENT

Paparella, Stephanie

From: David Richter >
Sent: November 11, 2019 2:31 PM
To: Paparella, Stephanie
Cc: Pauls, Esther
Subject: 2020 budget and proposed property tax increase

Categories: GIC Budgets.

Stephanie,

I wish to submit the following written submission to distribute to council on the subject of the 2020 City of Hamilton budget and proposed 5.5% property tax increase.

I have copied Esther Pauls above as she is the councillor for my Hamilton Mountain ward.

As a long time Hamilton resident and tax payer, I must say that I am stunned and shocked by the estimated 5.5 % increase in property taxes for 2020 I am reading about recently.

It is a well known fact that Hamilton has among the highest levels of property taxes in south-western Ontario, and adding another 5.5% for next year is simply unacceptable.

I realize there are many factors that go into the tax rates and the budget process, but there must be some further investigation by city council on how to contain the 2020 tax increase to something manageable for home owners. I'm sure within the city budget are large amounts of money for various grants, groups, non profits, etc. Perhaps these need to be cut back. Or while Holiday parades and such are very nice, perhaps these are a luxury we can no longer afford. Or the staff or operating budgets of city council needs to be cut back. I'm sure there are many ways to reduce spending and control the expenses to help reduce the increase.

I understand that the other higher levels of government are cutting back on what they send to local and regional governments, and I understand the pressure of trying to keep residents happy while trying to run local government and control the budget, but if you indeed approve a 5.5% increase to property taxes next year, I will cause many Hamilton residents hard ship and will have to cut back on other needs.

Sincerely, David Richter



INFORMATION REPORT

TO:	Mayor and Members General Issues Committee
COMMITTEE DATE:	January 17, 2020
SUBJECT/REPORT NO:	2020 Budget Overview (FCS20001) (City Wide)
WARD(S) AFFECTED:	City Wide
PREPARED BY:	Andreia Bevilacqua (905) 546-2424 Ext. 4190
SUBMITTED BY:	Brian McMullen Director, Financial Planning, Administration and Policy Corporate Services Department
SIGNATURE:	

COUNCIL DIRECTION

N/A

INFORMATION

At the General Issues Committee (GIC) meeting on July 8, 2019, Council approved the 2020 Budget Guidelines, Outlook and Process (Report FCS19054). The 2020 Budget Overview (Report FCS20001) provides an updated overview of the 2020 Budget Process and Schedule. Preliminary budget information will be provided to GIC in a staff presentation.

The 2020 Budget Process incorporates the following components:

Tax Supported Capital Budget and Rate Supported Budget:

The City of Hamilton's multi-year Capital Budget supports the City's planned investment in capital infrastructure and capital assets. The Tax Supported Capital Budget Available Funding represents a portion of the financing required to support the City's existing capital infrastructure repair and replacement requirements based on industry standards and Council priorities.

SUBJECT: 2020 Budget Overview (FCS20001) (City Wide) - Page 2 of 3

The 2020 Tax Supported Capital Budget (Report FCS19091) was approved by Council on December 11, 2019.

The City of Hamilton's Rate Supported Operating Budget provides the cost and ongoing financial obligations to deliver water, wastewater and stormwater programs and services to ratepayers. The City of Hamilton's Rate Supported Capital Budget supports the City's investment in capital infrastructure and capital assets. The cost for water, wastewater and stormwater programs are fully funded from user fees and, therefore, do not affect municipal property taxes.

The 2020 Recommended Water, Wastewater and Stormwater Budget (Report FCS19070) was approved by Council on November 27, 2019.

Tax Supported Operating Budget:

The City of Hamilton's Tax Supported Operating Budget provides the costs and ongoing financial obligations to deliver programs and services to taxpayers.

The 2020 Budget Overview (Report FCS20001) is submitted for Council's consideration with the overview to be presented at GIC on January 17, 2020. This includes the distribution of a budget book in the form of Appendix "A" – 2020 Preliminary Tax Supported Operating Budget Report.

Tax Supported User Fees:

The City of Hamilton's User Fees represent charges to individual users of specific municipal services and are an integral part of the annual budget process. Revenue estimates for the current budget year are based on the fees contained in the Tax Supported User Fee Report FCS19092 and other user fee reports are included in the Tax Supported Operating Budget.

The 2020 Tax Supported User Fees (Report FCS19092) was approved by Council on December 11, 2019.

The schedule for the meetings for the General Issues Committee is summarized in the following Table:

ITEM	DATE
Tax Supported Operating Budget Overview	January 17, 2020
Boards and Agencies Presentation	January 21 and 23, 2020
Departmental Budget Presentations	January 17, 28, 29, 30 and February 7, 2020
Public Delegations	February 10, 2020
GIC Budget Deliberations	February 24, 27 and March 2, 4, 2020
Council Budget Approval	April 1, 2020

OUR Vision: To be the best place to raise a child and age successfully.

OUR Mission: To provide high quality cost conscious public services that contribute to a healthy, safe and prosperous community, in a sustainable manner.

OUR Culture: Collective Ownership, Steadfast Integrity, Courageous Change, Sensational Service, Engaged Empowered Employees.

APPENDICES AND SCHEDULES ATTACHED

Appendix “A” to Report FCS20001 – 2020 Preliminary Tax Supported Operating Budget Report

(Due to the bulk size of Appendix “A”, it is not included as part of Report FCS20001 but is available for viewing in the City Clerk’s Office and online at www.hamilton.ca)

AB/dt



Hamilton

PRELIMINARY



2020 TAX SUPPORTED OPERATING BUDGET REPORT

CONTENT

1	2020 BUDGET SUMMARY REPORT
	APPENDICES
17	1 Net Levy Summary
23	2 Gross and Net Expenditure Summary
27	3 Cost Category Summary
29	4 Complement Summary
33	5 Departmental Budget Summaries
129	6 Council Referred Items
149	7 Business Cases
171	8 Multi-Year Outlook

2020 BUDGET SUMMARY REPORT

The City of Hamilton’s Preliminary Tax Supported Operating Budget of \$935.0 M requires a 5.0% municipal property tax increase, which translates to \$179 for the average residential property assessed at \$358,600.

The 2020 Preliminary Tax Supported Operating Budget for City Departments is increasing by \$29.0 M or 5.3%. This contributes to the average residential tax increase by 3.0% or \$106. This amount forms part of the 5.0% municipal property tax increase.

An estimated assessment growth benefit of (1.0%) and a reassessment impact of 0.5% reduce the initial levy increase from 5.4% to the average residential tax impact of 5.0%.

2020 MUNICIPAL PRELIMINARY TAX IMPACT FOR THE AVERAGE RESIDENTIAL PROPERTY TAX BILL Excludes Education Impact

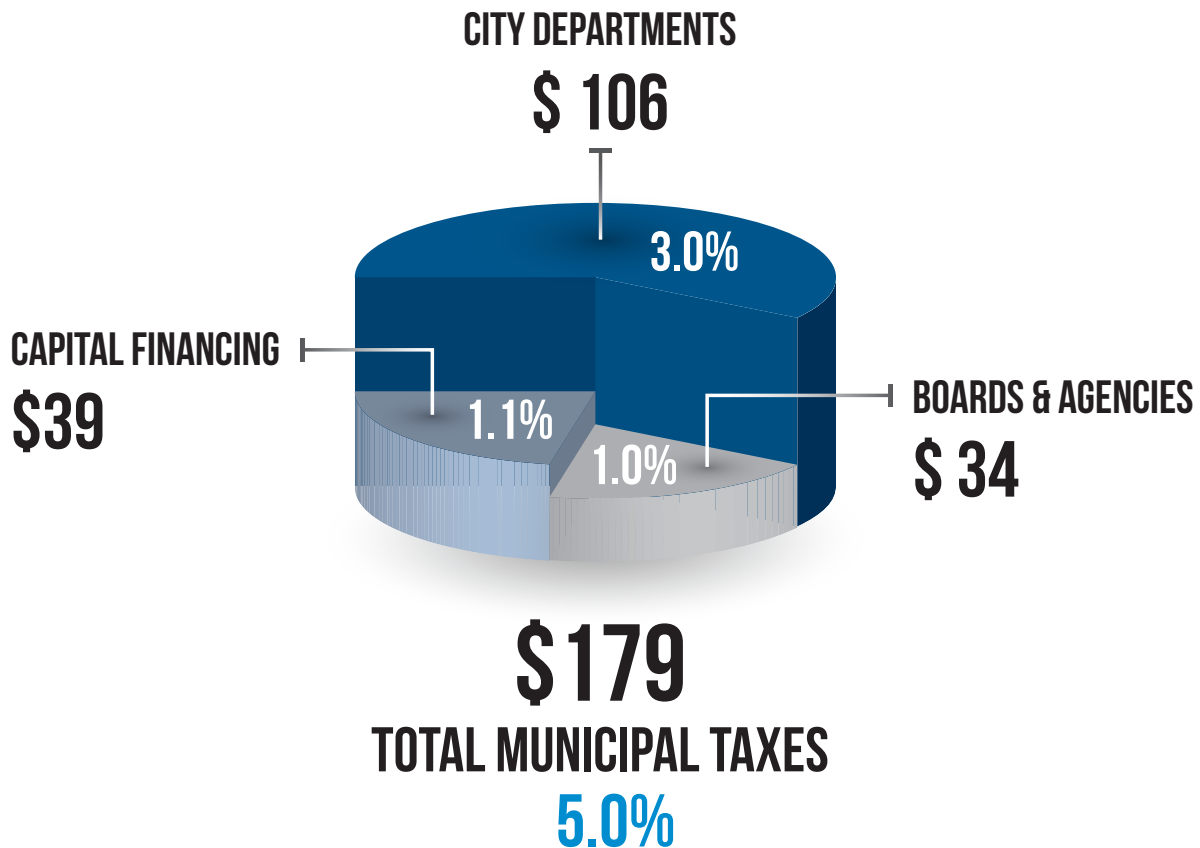

• Anomalies due to rounding • Assumes (1.0%) benefit for growth and 0.5% reassessment impact • Average residential assessment: \$358,600

This year’s Preliminary Tax Supported Operating Budget include significant investments in Transit, contributions to capital projects as well as protecting services that would have been lost due to changes in provincial funding. The Tax Supported Operating Budget also includes other key priorities that support the City’s Strategic Plan and contribute to the City’s vision to be the best place to raise a child and age successfully.

TRANSIT IMPACTS

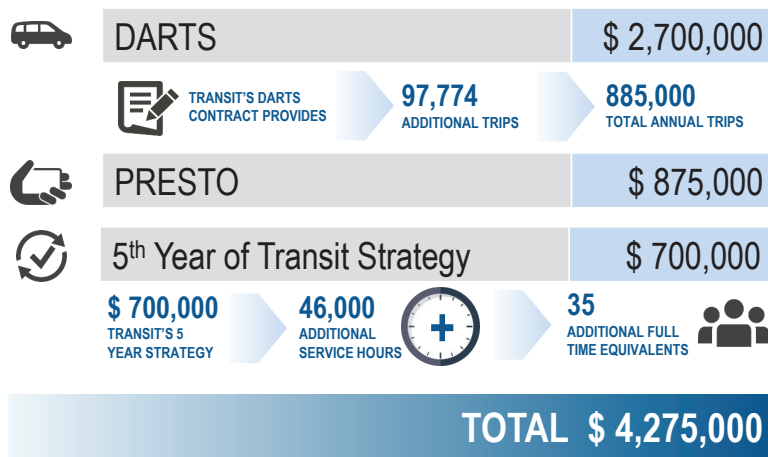

CAPITAL FINANCING

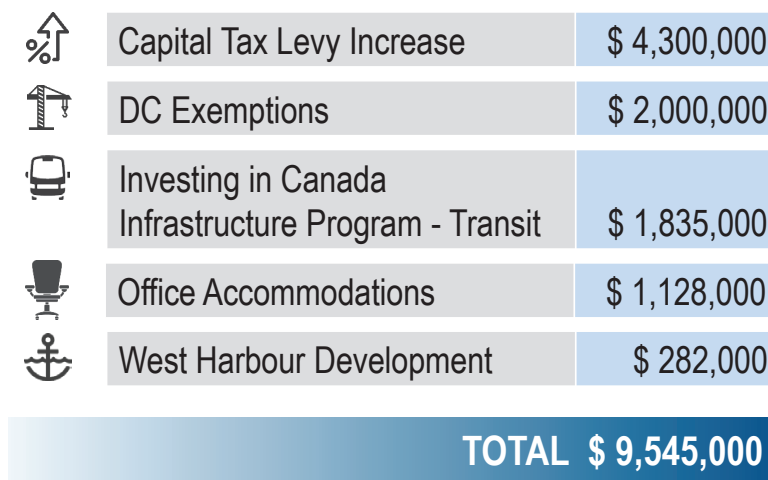

PROTECTING CHILD CARE SPACES

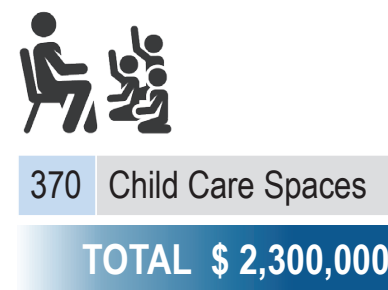

2020 TAX SUPPORTED OPERATING BUDGET

BUDGET PROCESS

The 2020 Preliminary Tax Supported Operating Budget is the result of an extensive process undertaken by City staff throughout 2019. The Tax Supported Operating Budget is one component of the City's overall annual budget and supports the delivery of all the City's services with the exception of Water, Wastewater and Storm Water services, which are Rate supported. Both the Tax and Rate supported service groups have infrastructure and facility requirements that are funded by their respective capital budgets. The 2020 Rate Operating and Capital Budget and the 2020 Tax Supported Capital Budget are being submitted separately for Council's consideration on November 25, 2019 and November 29, 2019 respectively. The 2020 Tax Supported User Fees are being submitted for Council's consideration on December 4, 2019.

The 2020 Preliminary Tax Supported Operating Budget overview will be presented to the General Issues Committee (GIC) on January 17, 2020 and the Departmental presentations will begin on January 28, 2020. The deliberation process and final budget approval is expected to be completed by late March 2020.

COUNCIL REFERRED ITEMS

Items that Council has referred by motion to the 2020 Operating Budget process are included in Appendix A to Report FCS20001- Appendix 6 "Council Referred Items". These items are not included in the preliminary budget totals.

BUSINESS CASES

Business Cases can be found in Appendix A to Report FCS20001- Appendix 7 “Business Cases”. The proposal of new revenue, request for additional resources to deliver services or any recommended changes to staffing levels are summarized in business cases for Council’s consideration. These items are not included in the preliminary budget totals.

MULTI-YEAR BUDGETS

Multi-Year budgeting strengthens the link between budgeting and strategic priorities and enables Council to implement a multi-year vision, assessing the long-term financial implications of current and proposed Operating and Capital Budgets, budget policies, investment policies, tax policies and assumptions.

A three-year outlook for 2021-2023 is summarized in Appendix A to Report FCS20001- Appendix 8 “Multi-Year Outlook” for the City. Three-year outlooks for 2021-2023 will also be presented by the General Managers during their departmental budget presentations. Making the multi-year budgets more prominent will assist towards approval in principle of these budgets, in the upcoming years.

BUSINESS PLANS

Multi-year business planning serves as a roadmap for municipalities to ensure Council’s priorities, as outlined in the City’s Strategic Plan, are converted into action. Each City department prepares multi-year business plans to identify and align departmental and divisional initiatives to the City’s vision “to be the best place to raise a child and age successfully,” with the Strategic Plan front and centre. The City does not have the financial resources or the organizational capacity to do everything at once. By establishing our priorities, creating achievable initiatives, and tracking progress with meaningful performance measurement, the City will realize its mission of providing high quality cost conscious public service that contributes to a healthy, safe and prosperous community.

Departmental and divisional initiatives are communicated during the departmental budget presentations as well as summarized in the Corporate Plan. The Corporate Plan is issued upon approval of all three budgets; Rate Supported Operating and Capital Budget, Tax Supported Capital Budget and Tax Supported Operating Budget.

2020 CONSOLIDATED BUDGET

Table 1 highlights the consolidated gross expenditure preliminary budgets for the City combining Tax and Rate supported services:

Table 1

2020 Preliminary Consolidated City Budget			
Gross Expenditures			
	Rate	Tax	Total
Operating	\$232.6 M	\$1,600.1 M	\$1,832.7 M
Capital	\$325.9 M	\$226.8 M	\$552.7 M
Total	\$558.5 M	\$1,829.6 M	\$2,285.4 M

Note: Does not include Council Referred Items or Business Cases

This document provides detailed information in respect of the 2020 Preliminary Tax Supported Operating Budget. As mentioned, the 2020 Rate Operating and Capital Budget and the 2020 Tax Supported Capital Budget are being submitted separately for Council’s consideration on November 25, 2019 and November 29, 2019 respectively.

During the 2019 Tax Supported Operating Budget process, staff prepared a 2020 - 2022 Multi-year Outlook based on assumptions and known increases. The initial Outlook for 2020 was projecting a levy increase of \$39.1 M and a 3.9% tax increase. Based on updated information, the initial projection has been revised to a levy increase of \$48.2 M and a 5.0% tax increase.

The 2020 Preliminary Tax Supported Operating Budget, as submitted, does not include any measures that would adversely impact programs and services. For this year, however, Council directed staff to report back on a series of scenarios in order to mitigate the projected average residential tax impact of 5.0%. Additional information on the mitigation options will be included in the “Budget Mitigation Options” section of this report.

2020 PRELIMINARY TAX SUPPORTED OPERATING BUDGET - TAX IMPACT

The submitted 2020 Preliminary Tax Supported Operating Budget requires a levy increase of \$48.2 M. This increase would result in an average residential municipal tax increase of 5.0% or \$179.

Table 2 highlights the municipal tax increase by major component:

Table 2

**2020 Municipal Preliminary Impact
For the Average Residential Property Tax Bill
(Excludes Education Impact)**

	\$	%
Municipal Taxes		
City Departments	\$ 106	3.0%
Boards & Agencies	\$ 34	1.0%
Capital Financing	\$ 39	1.1%
Total Municipal Taxes	\$ 179	5.0%

- Anomalies due to rounding
- Assumes (1.0%) benefit for growth and 0.5% reassessment impact
- Average residential assessment: \$358,600

As indicated in the table, the tax impact attributable to City departments is about 3.0%. The Boards and Agencies tax impact is 1.0%, subject to the approval of the Police Services’ budget (currently the budget assumes a 5-year average plus 2019 annualization of new hires) and the submission of the Niagara Peninsula Conservation Authority’s budget. An increase of 1.1% is recommended for the capital levy. Additional details can be found in the found in the “Summary” section of the Report.

Also submitted are Council Referred Items and Business Cases to be considered during the budget process. If approved as submitted, the Business Cases will add 0.1% to the tax impact while the Council Referred Items will increase the tax impact by 0.1%. The total tax impact inclusive of Council Referred Items and the Business Cases submissions would result in a tax impact of 5.2% for 2020.

2020 PRELIMINARY TAX SUPPORTED OPERATING BUDGET - SUMMARY

The 2020 Preliminary Tax Supported Operating Budget identifies a levy requirement of \$935.0 M, which represents a levy increase of \$48.2 M or 5.4% over 2019. Table 3 highlights the preliminary budgets by major component:

Table 3

2020 Preliminary Tax Budget					
	Net Operating Budget				
	2019	2020	Change 2020/2019		
	Restated \$	Preliminary \$	\$	%	
Total City Departments	\$ 542,735,000	\$ 571,746,000	\$ 29,010,000	5.3%	
Boards & Agencies	\$ 214,172,000	\$ 223,834,000	\$ 9,663,000	4.5%	
Capital Financing (*)	\$ 129,880,000	\$ 139,425,000	\$ 9,545,000	7.3%	
Total Preliminary Operating Budget	\$ 886,787,000	\$ 935,005,000	\$ 48,218,000	5.4%	
Average Residential Property Tax Impact				5.0%	

Note: The Capital Financing figure in Table 3 includes the Area Rating Special Capital Reinvestment provision allocated to the pre-amalgamated City of Hamilton through the Tax Supported Operating Budget.

An estimated assessment growth benefit of (1.0%) and a reassessment impact of 0.5% reduce the initial 2020 budget levy increase from 5.4% to the average residential tax impact of 5.0%.

City Departments

The 2020 Preliminary Tax Supported Operating Budget for City Departments is increasing by \$29.0 M or 5.3%. This contributes to the average residential tax increase by 3.0% or \$106 for the average home. This year the City is facing significant pressures due to maintenance items, changes in provincial funding, transit and operating impacts from capital.

Table 4 summarizes the individual maintenance items that are having a significant impact in the City departments.

Table 4

Budget Drivers - Maintenance	
Item	2020 Budget Impact
Salary and Wages / Benefits	\$9.3 M
Insurance Premiums	\$2.0 M
WSIB Shortfall	\$1.5 M
Road Salt Contract	\$1.5 M
Computer Software Licensing	\$1.5 M
Total Major Budget Drivers	\$15.8 M

Employee related expenses, primarily salaries, wages and benefits comprise approximately 34% of the City's tax supported operating budget excluding Boards & Agencies. The \$9.3 M increase is due to contractual settlements, cost of living adjustments (COLA) and staffing changes plus the resulting increase in employer and government benefits.

Other maintenance items include a \$2.0 M increase in insurance premiums and a \$1.5 M increase due to a WSIB shortfall originating from increased number of cases as well as higher costs per case. These two items are cost allocated to the departmental budgets. An additional pressure of \$1.5 M is due to recent negotiations in the road salt contract. Furthermore, \$1.5 M is due to a change in the delivery model of the computer software licensing city-wide.

In addition to maintenance items, there are a number of additional expenditures that are driving the budget increase in the City's departments. Table 5 highlights those items.

Table 5

Budget Drivers - Additional Items		
Item		2020 Budget Impact
Provincial Funding		\$4.7 M
Children's Services	\$2.3 M	
Public Health	\$1.4 M	
Ontario Works	\$1.0 M	
Transit		\$4.3 M
DARTS	\$2.7 M	
PRESTO	\$0.9 M	
Transit Strategy	\$0.7 M	
Operating Impacts from Capital		\$2.3 M
Traffic Management/Signalling	\$0.7 M	
Confederation Park	\$0.3 M	
Backflow Prevention	\$0.2 M	
IT Strategy	\$0.2 M	
Others	\$0.9 M	
Total Major Budget Drivers		\$11.3 M

(*) Anomalies due to rounding

One of most significant item affecting this year's budget is changes in provincial funding which represent a \$4.7 M pressure. \$2.3 M in the Children's Services and Neighborhood Development division is the result of reduced funding from 100% to 80% for Core Service Delivery and Ontario Early Years Child & Family Centres as well as changes to Expansion Funding impacting financial support to 370 child care spaces. Additional \$1.4 M are due to changes in funding from 100% subsidy to 70% subsidy in a number of programs in Public Health and another \$1.0 M also due to funding changes in Ontario Works. Provincial funding pressures for Public Health Services are partially mitigated by a one-time transitional funding of \$1.4 M.

A pressure of \$4.3 M in Transit is the result of contractual increases in Disabled and Aged Regional Transportation System (DARTS) of \$2.7 M due to ridership increase; the operating agreement with PRESTO is increasing the budget by \$875 K and year 5 of the 10-year Transit Strategy is adding \$688 K (net).

The 2020 operating impacts from previously approved capital projects are \$2.3 M. Major projects include new traffic signals (\$734 K), the redevelopment of Confederation Park (\$291 K), backflow prevention for various facilities (\$240 K) and the IT Strategy (\$235 K). A complete list of projects can be found in Appendix A to Report FCS20001 - Appendix 5 "Departmental Budget Summaries - Other Programs".

Boards & Agencies

The 2020 Preliminary Boards and Agencies Budget is increasing by \$9.7 M or 4.5% (excluding capital financing), which represents a tax impact for the average residential property of 1.0% or \$34. Table 6 summarizes the Boards & Agencies budgets.

Table 6

2020 Boards & Agencies Preliminary Budgets

Board/Agency	2019	2020 NET	Change	
	Budget Net \$	Preliminary Budget \$	\$	%
Conservation Authorities	\$ 5,498,000	\$ 8,179,000	\$ 2,681,000	48.8%
MPAC	\$ 6,715,000	\$ 6,849,000	\$ 134,000	2.0%
Hamilton Beach Rescue Unit	\$ 134,000	\$ 134,000	\$ -	0.0%
Hamilton Farmers' Market	\$ 113,000	\$ 113,000	\$ -	0.0%
Royal Botanical Gardens	\$ 635,000	\$ 635,000	\$ -	0.0%
Hamilton Police Services	\$ 164,290,000	\$ 170,509,000	\$ 6,219,000	3.8%
Hamilton Public Library	\$ 30,701,000	\$ 31,330,000	\$ 629,000	2.0%
City Enrichment Fund	\$ 6,086,000	\$ 6,086,000	\$ -	0.0%
Total for Above Items excluding Capital Financing	\$ 214,172,000	\$ 223,834,000	\$ 9,663,000	4.5%

The Police budget pressure of \$6.2 M is based on a five-year average levy increase of 3.0% and the annualization of FTE's approved during the 2019 budget process. The final 2020 budget will be presented by the Police Services Board in December 2020. Staff will update Council during the budget deliberations. The Hamilton Public Library is submitting a budget with a \$629 K (2.0%) increase from 2019. Employee related expenses and recoveries for insurance and facilities costs are the main drivers behind the increase.

The major pressure in Boards and Agencies, however, is related to the increased levy payable to the Conservation Authorities. The City had appealed the 2015-2019 Niagara Peninsula Conservation Authority (NPCA) levy and the 2018-2019 levies for the Grand River Conservation Authority, Hamilton Conservation Authority and Halton Conservation. The City was unsuccessful with the NPCA appeal and a judicial review. The NPCA appeal was repealed. Staff continues to review the other appeals. For 2020, the Conservation Authorities budget has been increased by \$2.5 M to reflect the court decision. The final budget submission from the Niagara Conservation Authority is still pending at the time of the preparation of this report.

All stakeholders within Boards and Agencies, with the exception of the City Enrichment Fund and the Municipal Property Assessment Corporation (MPAC), will present their budgets at GIC on January 21st and 23rd, 2020. Additional budget information can be found in Appendix A to Report FCS20001 - Appendix 5 "Departmental Budget Summaries - Other Programs".

Capital Financing

The operating budget portion of the 2020 Tax Supported Capital Budget is increasing by \$9.6 M representing a 1.1% or \$39 tax impact for the average residential property. Table 7 identifies these components.

Table 7

	2020	
	Change \$	Tax Impact %
Capital Tax Levy Increase	\$ 4,300,000	0.50%
DC Exemptions	\$ 2,000,000	0.23%
Investing in Canada Infrastructure Program - Transit	\$ 1,835,000	0.21%
Office Accommodations	\$ 1,128,000	0.14%
West Harbour Development	\$ 282,000	0.03%
Total	\$ 9,545,000	1.11%

The operating levy contribution to the capital budget for 2020 is \$4.3 M or 0.5% tax impact; \$2.9M of this increase is directed to fund the state of good repair of roads, bridges and sidewalks; \$1.0 M for transit and \$0.4 M for parkland acquisition.

In addition, debt financing requirements have resulted in proposed tax levy increases of \$2.0 M or 0.23% to fund Development Charges Exemptions, \$1.8 M or 0.21% for the City's funding share of the Investing in Canada Infrastructure Program ICIP – Transit (previously PTIF), \$1.1 M or 0.14% for the Downtown Office Accommodation project and \$0.3 M or 0.03% for the West Harbour Development project.

The 2020 Tax Supported Capital Budget is being presented to Council for consideration on November 29, 2019. The 2020 Tax Supported Capital Budget and the 10-year Tax Supported Capital Program supports the City's Strategic Plan and Financing Strategy and aligns with the following City objectives: rehabilitation of existing assets; leveraging funding programs from senior levels of government for transit, culture, recreation and housing; and targeted funding for growth to increase property assessment.

BUDGET MITIGATION OPTIONS

The task of achieving the desired tax levy and tax impact will involve a balance between the need to find levy reductions (reduce expenses or increase revenue) and the desire to protect services and programs. For the 2020 Tax Supported Operating Budget, Council directed staff to develop options to reduce the tax impact to 4.6%, 3.6% and 2.6%. Table 8 estimates the levy reduction required to achieve these tax impacts, with the preliminary municipal tax impact of 5.0% as the starting point:

Table 8

2020 Reduction Scenarios			
	Reductions	Levy Increase	Residential Tax Incr.
Preliminary Budget		\$ 48,217,000	5.0%
Total Reductions Of	\$ (3,500,000)	\$ 44,717,000	4.6%
Total Reductions Of	\$ (12,200,000)	\$ 36,017,000	3.6%
Total Reductions Of	\$ (20,900,000)	\$ 27,317,000	2.6%

Note - Excludes potential increases due to 2020 Referred Items and Business Cases

Approximately \$8.7 M is required to adjust the municipal tax impact by 1%

Staff have identified a number of options to achieve the different tax impacts, which can be categorized as financial, revenues and services. Some of the options to achieve a 4.6% tax impact include:

Financial: Reduce contributions to reserves impacting long term financial plan.

Revenues: Enhance user fee increases in several areas.

Services: Reduce response time to inquiries, request for service and policy work; Reduce service hours for facilities/programs; Reduce or eliminate service levels where service is under-utilized; Align service levels to comparator municipalities where the City exceeds those comparators; Align service levels to provincial funding; Reduce grants to external agencies.

To further reduce the tax impact to 3.6%, in addition to the options needed to achieve a 4.6% reduction, the following options would need to be considered:

Revenues: New user fees for services traditionally provided at no charge.

Services: Close facilities and related services not considered core municipal services or not required by provincial mandate; Reduce service levels in core areas.

STAFF COMPLEMENT

The 2020 Preliminary Tax Supported Operating Budget is submitted with a staff complement net increase of 2.9 Full Time Equivalents (FTE), excluding Boards and Agencies, compared to the 2019 Restated Complement. Table 9 illustrates the changes from 2019.

Table 9

2020 Preliminary Complement (FTE)											
(exclusive of Boards & Agencies)											
		Change									
2019 Approved	5,824.7										
2019 Restated	5,837.3	12.6									
<table style="width: 100%; border-collapse: collapse;"> <tr> <td style="width: 40%;">Impacts from Capital</td> <td style="width: 20%; text-align: right;">11.6</td> <td></td> </tr> <tr> <td>Other Complement Change</td> <td style="text-align: right;">(8.7)</td> <td></td> </tr> <tr> <td>2020 Preliminary</td> <td style="text-align: right;">5,840.2</td> <td style="text-align: right;">2.9</td> </tr> </table>			Impacts from Capital	11.6		Other Complement Change	(8.7)		2020 Preliminary	5,840.2	2.9
Impacts from Capital	11.6										
Other Complement Change	(8.7)										
2020 Preliminary	5,840.2	2.9									

* - Anomalies due to rounding

The difference of 12.6 FTE between the 2019 Approved and 2019 Restated is mostly due to annualization of previously approved enhancements and in-year approvals.

The 2020 submission includes a net change of 2.9 FTE which includes 11.6 FTE as a result of operating impacts from previously approved capital projects (Open Space Development and Traffic Management/Signaling). A net change of (8.7) FTE in the departments include a decrease of (44.0) FTE due to changes in provincial program funding and the addition of 35.0 FTE as a result of the continuation of the Transit Strategy.

Appendix A to Report FCS20001 - Appendix 4 "Complement Summary", provides a complement summary including footnotes explaining all of the complement changes. As well, the departmental presentations to GIC will provide additional information with respect to complement changes.

COUNCIL REFERRED ITEMS & BUSINESS CASES

Not included in the 2020 Preliminary Tax Supported Operating Budget are a number of items that were considered at Council via staff report or Councillor’s Motion and were referred to the budget process for further discussion. In addition to these Council Referred Items, departments have submitted ten Business Cases for Council’s consideration.

Appendix A to Report FCS20001 - Appendix 6 “Council Referred Items” provides additional information and detail sheets for these Council Referred Items. The nine Council Referred Items represent an increase of \$1.1 M and additional 14.5 FTE. The most significant item is the 10 Year Fire Service Delivery Plan. If approved, the impact on the average residential tax bill is an increase of 0.1%. Note, a number of the Council Referred Items are pending a calculation of required levy. Therefore approval of these items may increase the stated tax impact.

Appendix A to Report FCS20001 - Appendix 7 “Business Cases”, provides additional information and detail sheets for the Business Cases. The ten submissions represent a total levy increase of \$1.2 M and additional 28.2 FTE. If approved, the impact on the average residential tax bill would be an additional 0.1%.

MULTI-YEAR BUDGET OUTLOOK

The initial Tax Supported Operating Budget Outlook for 2021 and 2022 prepared during the 2019 budget process resulted in projected tax increases of 3.6% and 3.3% respectively. These projections, however, needed to be re-evaluated based on current information, tax increases above inflation and other known factors such as contractual agreements and operating impacts from capital projects, and needed to be adjusted based on the 2020 budget.

Appendix A to Report FCS20001 - Appendix 8 “Multi-Year Budget Outlook”, presents the multi-year outlook for 2021-2023. Table 10 below shows the projected levy and tax increases for the 2021-2023 period.

Table 10

2021 - 2023 Multi-Year Outlook

	2021		2022		2023	
	\$	%	\$	%	\$	%
Total City Departments	\$ 31,110,000	5.3%	\$ 18,739,000	3.0%	\$ 19,300,000	3.0%
Boards & Agencies	\$ 6,371,000	2.8%	\$ 6,474,000	2.8%	\$ 6,503,000	2.7%
Capital Financing	\$ 6,236,000	4.5%	\$ 5,815,000	4.0%	\$ 5,312,000	3.5%
Total Preliminary Operating Budget	\$ 43,717,000	4.7%	\$ 31,028,000	3.2%	\$ 31,115,000	3.1%
Residential Average Property Tax Impact		4.2%		2.7%		2.6%

The most significant item impacting future budgets is the change in provincial funding and cost sharing agreements. Significant increases are also due to Transit, both as a result of the continuation of the 10-Year Transit Strategy and increases in the DARTS contract due to increase ridership.

In addition, corporate financials include increases resulting from the operating impacts of capital projects as well as increases in insurance.

Actions taken to mitigate the pressures in the 2020 budget should not include postponing expenditures to future years but rather, they should be geared towards finding sustainable solutions.

For every year, the residential tax increase assumes a growth benefit of (1.0%) based on historical results and a reassessment impact of 0.5%. These assumptions, as well as all the other assumptions used in the preparation of the outlook such as inflation rate and the utility guidelines will be revised yearly.

The multi-year budgets will be included in the departmental presentations, which are scheduled to begin on January 28, 2020.

APPENDIX 1

**2020
Preliminary
Tax Supported
Operating Budget
Net Levy
Summary**

NET LEVY SUMMARY

	2019		2020 Preliminary vs. 2019 Restated %
	Restated Budget	Projected Actual	
	2020 Preliminary Budget		
PLANNING & ECONOMIC DEVELOPMENT			
General Manager	1,021,680	950,070	16,410 1.6%
Transportation, Planning and Parking Building	2,148,020	1,750,860	295,690 13.8%
Economic Development	1,273,970	1,304,460	(213,280) (16.7)%
Growth Management	5,359,750	5,424,280	61,720 1.2%
Licensing & By-Law Services	405,240	445,350	185,580 45.8%
LRT Office	6,615,610	6,879,690	30,340 0.5%
Planning	0	0	0 0.0%
Tourism & Culture	3,368,470	3,330,690	373,800 11.1%
	9,141,260	9,269,800	78,280 0.9%
TOTAL PLANNING & ECONOMIC DEVELOPMENT	29,334,000	29,355,200	828,540 2.8%

HEALTHY AND SAFE COMMUNITIES			
HSC Administration	2,760,720	2,919,010	36,100 1.3%
Children's Services and Neighbourhood Dev.	8,675,010	8,543,680	2,306,610 26.6%
Ontario Works	11,918,050	11,288,700	1,125,330 9.4%
Housing Services	45,068,420	41,635,250	211,410 0.5%
Long Term Care	13,472,300	13,336,740	609,110 4.5%
Recreation	33,503,780	33,718,260	678,020 2.0%
Hamilton Fire Department	92,083,970	92,103,520	1,605,740 1.7%
Hamilton Paramedic Service	23,794,770	24,500,820	1,314,000 5.5%
Public Health Services	12,356,500	12,546,620	1,116,490 9.0%
TOTAL HEALTHY AND SAFE COMMUNITIES	243,633,520	240,592,600	9,002,810 3.7%

Note: Projected Actuals have not been restated for the organizational structure changes that are reflected in restatement of budget program expenditures and revenues.

NET LEVY SUMMARY

	2019		2020 Preliminary vs. 2019 Restated %	
	Restated Budget	Projected		2020 Preliminary Budget
		Actual		
PUBLIC WORKS				
PW-General Administration	874,810	715,220	28,730 3.3%	
Energy Fleet and Facilities	8,718,820	9,893,420	578,540 6.6%	
Engineering Services	0	0	0 0.0%	
Environmental Services	79,243,370	82,794,430	3,551,060 4.5%	
Transit	74,298,880	76,213,180	7,096,830 9.6%	
Transportation Operations & Maintenance	78,920,680	78,214,040	2,519,890 3.2%	
TOTAL PUBLIC WORKS	242,056,560	243,280,500	13,775,050 5.7%	
LEGISLATIVE				
Legislative General	(373,660)	(168,350)	14,090 3.8%	
Mayors Office	1,118,300	1,133,660	45,720 4.1%	
Volunteer Committee	112,650	112,650	0 0.0%	
Ward Budgets	4,113,730	3,936,730	56,390 1.4%	
TOTAL LEGISLATIVE	4,971,020	5,014,690	116,200 2.3%	
CITY MANAGER				
CMO - Admin & Digital Office	391,750	474,190	29,260 7.5%	
Office of the City Auditor	1,129,980	1,082,310	21,730 1.9%	
Strategic Partnerships & Communications	3,025,040	2,711,310	112,800 3.7%	
Human Resources	7,396,650	7,216,880	155,910 2.1%	
TOTAL CITY MANAGER	11,943,420	11,484,690	319,700 2.7%	

Note: Projected Actuals have not been restated for the organizational structure changes that are reflected in restatement of budget program expenditures and revenues.

NET LEVY SUMMARY

	2019		2020 Preliminary vs. 2019 Restated %	
	Restated Budget	Projected		2020 Preliminary Budget
		Actual		
CORPORATE SERVICES				
Corporate Services - Administration	315,420	317,840	9,430 3.0%	
City Clerk's Office	2,619,110	2,239,990	171,510 6.5%	
Customer Service	5,555,340	5,290,280	(30,370) (0.5)%	
Financial Planning, Admin & Policy	4,817,260	4,755,050	97,230 2.0%	
Financial Services	3,975,310	3,659,320	271,490 6.8%	
Information Technology	11,494,450	10,820,350	8,940 0.1%	
Legal Services	3,505,470	3,382,750	(89,120) (2.5)%	
TOTAL CORPORATE SERVICES	32,282,360	30,465,580	439,110 1.4%	

CORPORATE FINANCIALS - EXPENDITURES			
Corporate Initiatives	4,222,500	4,120,250	4,091,200 96.9%
Corporate Pensions, Benefits & Contingency	15,344,590	15,584,660	601,560 3.9%
TOTAL CORPORATE FINANCIALS	19,567,090	19,704,910	4,692,760 24.0%

HAMILTON ENTERTAINMENT FACILITIES			
Operating	3,912,390	4,078,010	588,800 15.0%
TOTAL HAMILTON ENTERTAINMENT FACILITIES	3,912,390	4,078,010	588,800 15.0%

TOTAL CITY EXPENDITURES	587,700,360	583,976,180	617,463,330 29,762,970 5.1%
--------------------------------	--------------------	--------------------	------------------------------------

Note: Projected Actuals have not been restated for the organizational structure changes that are reflected in restatement of budget program expenditures and revenues.

NET LEVY SUMMARY

	2019		2020 Preliminary Budget	2020 Preliminary vs. 2019 Restated	
	Restated Budget	Projected Actual		\$	%
CAPITAL FINANCING					
Debt-Healthy & Safe Communities	2,339,720	4,409,570	2,339,720	0	0.0%
Debt-Infrastructure Renewal Levy	13,428,870	13,428,870	13,428,870	0	0.0%
Debt-Corporate Financials	74,224,300	71,112,580	83,769,300	9,545,000	12.9%
Debt-Planning & Economic Development	194,070	88,360	194,070	0	0.0%
Debt-Public Works	38,695,920	35,077,860	38,695,920	0	0.0%
TOTAL CAPITAL FINANCING	128,882,880	124,117,240	138,427,880	9,545,000	7.4%

	2019		2020 Preliminary Budget	2020 Preliminary vs. 2019 Restated	
	Restated Budget	Projected Actual		\$	%
BOARDS & AGENCIES					
Police Services					
Operating	164,290,320	164,290,320	170,508,940	6,218,620	3.8%
Capital Financing	805,750	805,750	805,750	0	0.0%
Total Police Services	165,096,070	165,096,070	171,314,690	6,218,620	3.8%
Other Boards & Agencies					
Library	30,700,750	30,700,190	31,329,600	628,850	2.0%
Conservation Authorities	5,497,900	8,025,760	8,178,740	2,680,840	48.8%
MPAC	6,715,220	6,715,220	6,849,520	134,300	2.0%
Hamilton Beach Rescue Unit	134,340	134,340	134,340	0	0.0%
Royal Botanical Gardens	634,720	634,720	634,720	0	0.0%
Farmers Market	112,800	132,610	112,800	0	0.0%
Total Other Boards & Agencies	43,795,730	46,342,840	47,239,720	3,443,990	7.9%

Note: Projected Actuals have not been restated for the organizational structure changes that are reflected in restatement of budget program expenditures and revenues.

NET LEVY SUMMARY

	2019		2020 Preliminary vs. 2019 Restated %	
	Restated Budget	Projected		2020 Preliminary Budget
		Actual		
Capital Financing - Other Boards & Agencies	191,240	191,240	0 0.0%	
City Enrichment Fund	6,085,610	6,115,890	0 0.0%	
TOTAL BOARDS & AGENCIES	215,168,650	217,746,040	9,662,610 4.5%	
TOTAL EXPENDITURES	931,751,890	925,839,460	48,970,580 5.3%	
NON PROGRAM REVENUES				
Payment In Lieu	(15,726,700)	(16,027,400)	(299,600) (1.9)%	
Penalties and Interest	(10,500,000)	(12,000,000)	(500,000) (4.8)%	
Right of Way	(3,228,000)	(3,226,930)	0 0.0%	
Senior Tax Credit	587,000	562,230	(20,000) (3.4)%	
Supplementary Taxes	(9,125,000)	(9,125,000)	(300,000) (3.3)%	
Tax Remissions and Write Offs	9,790,400	9,355,000	(190,400) (1.9)%	
Hydro Dividend and Other Interest	(5,300,000)	(4,947,000)	697,060 13.2%	
Investment Income	(4,100,000)	(4,100,000)	0 0.0%	
Slot Revenues	(5,000,000)	(5,000,000)	(200,000) (4.0)%	
POA Revenues	(2,362,200)	(2,362,200)	59,820 2.5%	
TOTAL NON PROGRAM REVENUES	(44,964,500)	(46,871,300)	(753,120) (1.7)%	
TOTAL LEVY REQUIREMENT	886,787,390	878,968,160	48,217,460 5.4%	
AVERAGE RESIDENTIAL MUNICIPAL TAX IMPACT			5.0%	

APPENDIX 2

**2020
Preliminary
Tax Supported
Operating Budget
Gross and Net
Expenditures
Summary**

GROSS AND NET EXPENDITURES SUMMARY

	Gross Expenditures			Gross Revenues			Net Operating Budget		
	2019 Restated Budget	2020 Preliminary Budget	% Change	2019 Restated Budget	2020 Preliminary Budget	% Change	2019 Restated Budget	2020 Preliminary Budget	2020 Preliminary vs. 2019 Restated %
PLANNING & ECONOMIC DEVELOPMENT									
General Manager	1,193,630	1,217,250	2.0%	(171,950)	(179,160)	(4.2)%	1,021,680	1,038,090	1.6%
Transportation, Planning and Parking Building	16,249,100	16,630,320	2.4%	(14,095,080)	(14,186,610)	(0.6)%	2,148,020	2,443,710	13.8%
Economic Development	14,108,580	14,880,730	5.5%	(12,834,610)	(13,820,040)	(7.7)%	1,273,970	1,060,690	(16.7)%
Growth Management	8,584,630	8,837,830	2.9%	(3,224,880)	(3,416,360)	(5.9)%	5,359,750	5,421,470	1.2%
Licensing & By-Law Services	6,900,610	6,819,740	(1.2)%	(6,495,370)	(6,228,920)	4.1%	405,240	590,820	45.8%
LRT Office	12,775,320	12,670,260	(0.8)%	(6,159,710)	(6,024,310)	2.2%	6,615,610	6,645,950	0.5%
Planning	8,606,550	9,196,740	6.9%	(8,606,550)	(9,196,740)	(6.9)%	0	0	0.0%
Tourism & Culture	8,977,150	9,822,510	(8.6)%	(6,454,040)	(5,234,880)	18.9%	3,368,470	3,742,270	11.1%
TOTAL PLANNING & ECONOMIC DEVELOPMENT	10,471,210	10,617,550	1.4%	(1,329,950)	(1,398,010)	(5.1)%	9,141,260	9,219,540	0.9%
	88,706,140	89,847,570	1.3%	(59,372,140)	(59,685,030)	(0.5)%	29,334,000	30,162,540	2.8%

HEALTHY AND SAFE COMMUNITIES									
HSC Administration	3,100,450	3,140,320	1.3%	(399,710)	(343,500)	(1.1)%	2,760,720	2,796,820	1.3%
Children's Services and Neighbourhood Dev.	93,659,390	93,604,240	(0.1)%	(84,984,380)	(82,622,620)	2.8%	8,675,010	10,981,620	26.6%
Ontario Works	153,082,450	143,509,570	(6.3)%	(41,164,400)	(30,466,190)	7.6%	11,918,050	13,043,980	9.4%
Housing Services	91,231,810	91,230,470	0.0%	(46,163,370)	(45,950,620)	0.5%	45,068,420	45,279,830	0.5%
Long Term Care	46,319,570	46,813,860	1.1%	(32,847,260)	(32,732,450)	0.3%	13,472,300	14,081,410	4.5%
Recreation	53,185,920	53,724,390	1.0%	(19,682,140)	(19,542,590)	0.7%	33,503,780	34,181,800	2.0%
Hamilton Fire Department	92,511,720	94,239,730	1.9%	(427,750)	(550,020)	(28.6)%	92,083,970	93,689,710	1.7%
Hamilton Paramedic Service	51,827,330	52,801,160	2.9%	(27,532,560)	(27,692,390)	(0.6)%	23,794,770	25,108,770	5.5%
Public Health Services	51,522,580	53,714,350	4.3%	(39,166,050)	(40,241,360)	(2.7)%	12,356,500	13,472,990	9.0%
TOTAL HEALTHY AND SAFE COMMUNITIES	635,941,200	632,778,090	(0.5)%	(392,307,620)	(380,141,740)	3.1%	243,633,520	252,636,330	9.0%

PUBLIC WORKS									
PW-General Administration	874,810	903,540	3.3%	0	0	0.0%	874,810	903,540	3.3%
Energy Fleet and Facilities	19,530,760	19,433,110	(0.5)%	(10,811,940)	(10,135,750)	6.3%	8,718,820	9,297,360	6.6%
Engineering Services	20,188,660	20,572,580	1.9%	(20,188,660)	(20,572,580)	(1.9)%	0	0	0.0%
Environmental Services	100,198,420	104,040,500	3.8%	(20,955,050)	(21,246,070)	(1.4)%	79,243,370	82,794,430	4.5%
Transit	130,791,570	141,439,580	8.1%	(56,492,690)	(60,043,870)	(6.3)%	74,298,880	81,395,710	9.6%
Transportation Operations & Maintenance	92,251,380	93,190,760	1.0%	(13,330,700)	(11,750,190)	11.9%	78,920,680	81,440,570	3.2%
TOTAL PUBLIC WORKS	363,835,600	379,580,070	4.3%	(121,779,040)	(123,748,460)	(1.6)%	242,056,560	255,831,610	5.7%

GROSS AND NET EXPENDITURES SUMMARY

	Gross Expenditures			Gross Revenues			Net Operating Budget			
	2019 Restated Budget	2020 Preliminary Budget	% Change	2019 Restated Budget	2020 Preliminary Budget	% Change	2019 Restated Budget	2020 Preliminary Budget	2020 Preliminary vs. 2019 Restated %	
LEGISLATIVE										
Legislative General	(375,660)	(359,570)	3.8%	0	0	0.0%	(375,660)	(359,570)	14,090	3.8%
Mayors Office	1,118,300	1,164,020	4.1%	0	0	0.0%	1,118,300	1,164,020	45,720	4.1%
Volunteer Committee	142,160	112,650	(20.8)%	(29,510)	0	100.0%	112,650	112,650	0	0.0%
Ward Budgets	4,113,730	4,170,120	1.4%	0	0	0.0%	4,113,730	4,170,120	56,390	1.4%
TOTAL LEGISLATIVE	5,000,530	5,087,220	1.7%	(29,510)	0	100.0%	4,971,020	5,087,220	116,200	2.3%
CITY MANAGER										
CMO- Admin & Digital Office	421,750	451,010	6.9%	(30,000)	(30,000)	0.0%	391,750	421,010	29,260	7.5%
Office of the City Auditor	1,159,980	1,181,710	1.9%	(30,000)	(30,000)	0.0%	1,129,980	1,151,710	21,730	1.9%
Strategic Partnerships & Communications	4,370,360	4,467,820	2.2%	(1,345,320)	(1,329,980)	1.1%	3,025,040	3,137,840	112,800	3.7%
Human Resources	9,450,540	9,638,340	2.0%	(2,053,890)	(2,085,780)	(1.6)%	7,396,650	7,552,560	155,910	2.1%
TOTAL CITY MANAGER	15,402,630	15,738,880	2.2%	(3,459,210)	(3,475,760)	(0.5)%	11,943,420	12,263,120	319,700	2.7%
CORPORATE SERVICES										
Corporate Services - Administration	315,420	324,850	3.0%	0	0	0.0%	315,420	324,850	9,430	3.0%
City Clerk's Office	3,202,650	3,374,160	5.4%	(583,540)	(583,540)	0.0%	2,619,110	2,790,620	171,510	6.5%
Customer Service	10,444,700	11,875,160	13.7%	(4,889,360)	(6,350,190)	(29.9)%	5,555,340	5,524,970	(30,370)	(0.5)%
Financial Planning, Admin & Policy	7,223,200	7,322,250	1.4%	(2,405,940)	(2,407,760)	(0.1)%	4,817,260	4,914,490	97,230	2.0%
Financial Services	6,757,840	7,088,390	4.9%	(2,782,530)	(2,841,590)	(2.1)%	3,975,310	4,246,800	271,490	6.8%
Information Technology	16,069,380	15,076,640	0.0%	(4,574,930)	(4,573,250)	0.0%	11,494,450	11,503,390	8,940	0.1%
Legal Services	4,394,110	4,404,990	0.2%	(888,640)	(988,640)	(11.3)%	3,505,470	3,416,350	(89,120)	(2.5)%
TOTAL CORPORATE SERVICES	48,407,300	50,466,440	4.3%	(16,124,940)	(17,744,970)	(10.0)%	32,282,360	32,721,470	439,110	1.4%
CORPORATE FINANCIALS - EXPENDITURES										
Corporate Initiatives	4,444,100	8,535,300	92.1%	(221,600)	(221,600)	0.0%	4,222,500	8,313,700	4,091,200	96.9%
Corporate Pensions, Benefits & Contingency	16,374,480	12,797,850	(21.8)%	(1,029,900)	3,146,300	405.7%	15,344,580	15,946,150	601,560	3.9%
TOTAL CORPORATE FINANCIALS	20,818,580	21,333,150	2.5%	(1,251,500)	2,926,700	333.9%	19,567,080	24,259,850	4,692,760	24.0%
HAMILTON ENTERTAINMENT FACILITIES										
Operating	4,380,360	4,866,960	11.1%	(467,970)	(365,770)	21.8%	3,912,390	4,501,190	588,800	15.0%
TOTAL HAMILTON ENTERTAINMENT FACILITIES	4,380,360	4,866,960	11.1%	(467,970)	(365,770)	21.8%	3,912,390	4,501,190	588,800	15.0%
TOTAL CITY EXPENDITURES	1,182,492,350	1,199,698,380	1.5%	(594,791,930)	(582,235,030)	2.1%	587,700,360	617,463,330	29,762,970	5.1%

GROSS AND NET EXPENDITURES SUMMARY

	Gross Expenditures			Gross Revenues			Net Operating Budget			
	2019 Restated Budget	2020 Preliminary Budget	% Change	2019 Restated Budget	2020 Preliminary Budget	% Change	2019 Restated Budget	2020 Preliminary Budget	2020 Preliminary vs. 2019 Restated %	
CAPITAL FINANCING										
Debt-Planning & Economic Development	255,250	255,250	0.0%	(61,180)	(61,180)	0.0%	194,070	194,070	0	0.0%
Debt-Healthy and Safe Communities	5,675,260	5,675,260	0.0%	(3,335,540)	(3,335,540)	0.0%	2,339,720	2,339,720	0	0.0%
Debt-Public Works	45,397,280	45,397,280	0.0%	(6,701,360)	(6,701,360)	0.0%	38,695,920	38,695,920	0	0.0%
Debt-Corporate Financials	74,224,300	83,769,300	12.9%	0	0	0.0%	74,224,300	83,769,300	9,545,000	12.9%
Infrastructure Renewal Levy	13,428,870	13,428,870	0.0%	0	0	0.0%	13,428,870	13,428,870	0	0.0%
TOTAL CAPITAL FINANCING	139,980,960	148,525,960	6.9%	(10,098,080)	(10,098,080)	0.0%	128,882,880	138,427,880	9,545,000	7.4%
BOARDS & AGENCIES										
Police Services										
Operating	176,780,650	182,999,270	3.5%	(12,490,330)	(12,490,330)	0.0%	164,290,320	170,508,940	6,218,620	3.8%
Capital Financing	1,116,130	1,116,130	0.0%	(310,380)	(310,380)	0.0%	805,750	805,750	0	0.0%
Total Police Services	177,896,780	184,115,400	3.5%	(12,800,710)	(12,800,710)	0.0%	165,096,070	171,314,690	6,218,620	3.8%
Other Boards & Agencies										
Library	32,513,670	33,103,990	1.8%	(1,812,920)	(1,774,390)	2.1%	30,700,750	31,329,600	628,850	2.0%
Conservation Authorities	5,497,900	8,178,740	48.8%	0	0	0.0%	5,497,900	8,178,740	2,680,840	48.8%
MPAC	6,715,220	6,849,520	2.0%	0	0	0.0%	6,715,220	6,849,520	134,300	2.0%
Hamilton Beach Rescue Unit	134,340	134,340	0.0%	0	0	0.0%	134,340	134,340	0	0.0%
Royal Botanical Gardens	634,720	634,720	0.0%	0	0	0.0%	634,720	634,720	0	0.0%
Farmers' Market	821,480	805,460	(2.0)%	(708,680)	(692,660)	2.3%	112,800	112,800	0	0.0%
Total Other Boards & Agencies	46,317,330	49,706,770	7.3%	(2,521,600)	(2,467,050)	2.2%	43,795,730	47,239,720	3,443,990	7.9%
Capital Financing - Other Boards & Agencies	472,730	472,730	0.0%	(281,490)	(281,490)	0.0%	191,240	191,240	0	0.0%
City Enrichment Fund	6,085,610	6,085,610	0.0%	0	0	0.0%	6,085,610	6,085,610	0	0.0%
TOTAL BOARDS & AGENCIES	230,772,450	240,380,510	4.2%	(15,603,800)	(15,549,250)	0.3%	215,168,650	224,831,260	9,662,610	4.5%
TOTAL EXPENDITURES	1,552,245,760	1,588,604,850	2.3%	(620,493,810)	(607,882,360)	2.0%	931,751,890	980,722,470	48,970,580	5.3%

GROSS AND NET EXPENDITURES SUMMARY

	Gross Expenditures		Gross Revenues		Net Operating Budget		
	2019 Restated Budget	2020 Preliminary Budget	% Change	2019 Restated Budget	2020 Preliminary Budget	2020 Preliminary vs. 2019 Restated \$	%
NON PROGRAM REVENUES							
Payment In Lieu	500,000	500,000	0.0%	(16,225,700)	(16,026,300)	(299,600)	(1.9)%
Penalties and Interest	0	0	0.0%	(10,500,000)	(11,000,000)	(500,000)	(4.8)%
Right of Way	0	0	0.0%	(3,228,000)	(3,228,000)	0	0.0%
Senior Tax Credit	685,000	665,000	(2.9)%	(98,000)	567,000	(20,000)	(3.4)%
Supplementary Taxes	100,000	100,000	0.0%	(9,225,000)	(9,425,000)	(300,000)	(3.3)%
Tax Remissions and Write Offs	0	0	0.0%	(10,500,000)	9,600,000	(190,400)	(1.9)%
Hydro Dividend and Other Interest	8,800,000	10,256,060	16.5%	(14,100,000)	(4,602,940)	697,060	13.2%
Investment Income	0	0	0.0%	(4,100,000)	(4,100,000)	0	0.0%
Slot Revenues	0	0	0.0%	(5,000,000)	(5,200,000)	(200,000)	(4.0)%
POA Revenues	0	0	0.0%	(2,362,200)	(2,302,380)	59,820	2.5%
TOTAL NON PROGRAM REVENUES	10,085,000	11,521,060	14.2%	(75,399,900)	(77,838,680)	(44,964,500)	(1.7)%

TOTAL LEVY REQUIREMENT	1,562,330,760	1,600,125,910	2.4%	(695,833,710)	(685,721,040)	886,787,390	935,004,850	48,217,460	5.4%
-------------------------------	----------------------	----------------------	-------------	----------------------	----------------------	--------------------	--------------------	-------------------	-------------

AVERAGE RESIDENTIAL MUNICIPAL TAX IMPACT									5.0%
---	--	--	--	--	--	--	--	--	-------------

APPENDIX 3

**2020
Preliminary
Tax Supported
Operating Budget
Cost Category
Summary**

COST CATEGORY SUMMARY

Tax (Excluding Boards & Agencies)

	2019 Restated Budget	2019 Projected Actual	2020 Preliminary Budget	2020 Preliminary vs. 2019 Restated \$	%
EMPLOYEE RELATED COSTS	608,305,910	608,415,280	617,609,060	9,303,150	1.5%
MATERIAL AND SUPPLY	47,582,350	48,372,360	51,137,860	3,555,510	7.5%
VEHICLE EXPENSES	36,432,830	35,919,320	37,379,640	946,810	2.6%
BUILDING AND GROUND	40,210,820	40,069,380	39,768,760	(442,060)	(1.1)%
CONSULTING	1,846,780	2,220,320	2,331,130	484,350	26.2%
CONTRACTUAL	111,318,880	113,270,800	117,076,260	5,757,380	5.2%
AGENCIES and SUPPORT PAYMENTS	291,853,270	284,003,980	284,592,630	(7,260,640)	(2.5)%
RESERVES / RECOVERIES	33,293,770	35,109,540	35,190,230	1,896,460	5.7%
COST ALLOCATIONS	(6,557,270)	(6,297,520)	(7,407,290)	(850,020)	(13.0)%
FINANCIAL	38,895,100	38,198,950	40,867,860	1,972,760	5.1%
CAPITAL FINANCING	138,166,260	133,520,240	150,799,260	12,633,000	9.1%
TOTAL EXPENDITURES	1,341,348,700	1,332,802,650	1,369,345,400	27,996,700	2.1%
FEES AND GENERAL	(203,326,100)	(212,509,560)	(211,214,210)	(7,888,110)	(3.9)%
TAX AND RATES	(29,059,700)	(29,479,330)	(29,679,300)	(619,600)	(2.1)%
GRANTS AND SUBSIDIES	(378,955,820)	(369,977,160)	(367,437,020)	11,518,800	3.0%
RESERVES	(27,175,990)	(29,506,150)	(19,019,970)	8,156,020	30.0%
RECOVERIES FROM CAPITAL	(31,212,300)	(30,108,280)	(31,821,290)	(608,990)	(2.0)%
TOTAL REVENUES	(669,729,910)	(671,580,480)	(659,171,790)	10,558,120	1.6%
NET LEVY	671,618,790	661,222,170	710,173,610	38,554,820	5.7%

APPENDIX 4

**2020
Preliminary
Tax Supported
Operating Budget
Complement
Summary**

COMPLEMENT SUMMARY

	2019 Approved Budget	2019 Restated Budget	2020 Preliminary Budget	2020 Preliminary vs. 2019 Restated	
				FTE	%
PLANNING & ECONOMIC DEVELOPMENT					
General Manager ¹	10.00	9.00	9.00	0.00	0.0%
Transportation, Planning and Parking ^{2,3}	138.24	136.74	137.74	1.00	0.7%
Building ^{4,5}	108.32	108.32	108.32	0.00	0.0%
Economic Development ¹	40.53	41.53	41.53	0.00	0.0%
Growth Management	56.34	56.34	56.34	0.00	0.0%
Licensing & By-Law Services ^{6,7}	111.15	110.15	108.15	(2.00)	(1.8)%
LRT Office ⁸	18.25	12.25	12.25	0.00	0.0%
Planning	78.00	78.00	78.00	0.00	0.0%
Tourism & Culture ⁹	73.29	72.29	72.29	0.00	0.0%
Total Planning & Economic Development	634.12	624.62	623.62	(1.00)	(0.2)%

1. Approved to Restated: Decrease 1.0 FTE fromto Ec Dev from GM Office FCS19055(a)
2. Approved to Restated: Decrease 1.0 FTE from Admin Secty to CS; 0.5 FTE from SCG to F&A, FCS19055
3. Restated to Preliminary: Increase of 1.0 FTE Program Coordinator Smart Commute PED 19124
4. Approved to Restated: Decrease 1.0 FTE due to administrative staff re-org PED 13174
5. Approved to Restated: Increase 1.0 FTE Zoning Examiner based on PED 13174
6. Approved to Restated: Decrease 1.0 FTE Lic Clerk to CS FCS19055
7. Restated to Preliminary: Decrease 2.0 FTE Graffiti pilot ends Dec 2019 PW17078 / PED17198
8. Approved to Restated: Decrease 6.0 FTE to PW per FCS19055(a)
9. Approved to Restated: Decrease 1.0 FTE Coordinator restated to HSC Rec Division PED19087/HSC19018

COMPLEMENT SUMMARY

	2019 Approved Budget	2019 Restated Budget	2020 Preliminary Budget	2020 Preliminary vs. 2019 Restated	
				FTE	%
HEALTHY AND SAFE COMMUNITIES					
HSC Administration	32.50	32.50	32.50	0.00	0.0%
Children's Services and Neighbourhood Dev.	94.00	94.00	94.00	0.00	0.0%
Ontario Works ^{1,5}	266.00	262.00	218.00	(44.00)	(16.8)%
Housing Services ⁶	54.00	54.00	53.00	(1.00)	(1.9)%
Long Term Care	458.55	458.55	458.55	0.00	0.0%
Recreation ^{1,2}	454.23	450.23	450.23	0.00	0.0%
Hamilton Fire Department ¹	586.30	582.30	582.30	0.00	0.0%
Hamilton Paramedic Service ³	314.36	324.36	324.36	0.00	0.0%
Public Health Services ^{4,7,8}	393.85	393.43	395.73	2.30	0.6%
Total Healthy and Safe Communities	2,653.79	2,651.37	2,608.67	(42.70)	(1.6)%

1. Approved to Restated: Decrease of OW 4.0 FTE, Recreation 3.0 FTE and Fire 4.0 FTE as it relates to the IT Centralization (FCS19055).
2. Approved to Restated: Decrease of 2.0 FTE for Marketing Centralization (FCS17056) and Increase of 1.0 FTE for SEAT position from Culture to Recreation (HSC19018).
3. Approved to Restated: Increase 10.0 FTE related to NICU 100% Funding (HSC19021).
4. Approved to Restated: Decrease 0.25 FTE Social Workers (BOH19001/BOH19025) ADGS/Mental Health; decrease 0.17 FTE Clinical Therapist MA Child & Adolescent Services (BOH19036).
5. Restated to Preliminary: Decrease of 44.0 FTE's due to changes in Provincial Program Funding.
6. Restated to Preliminary: Decrease 1.0 FTE due to end of Federal/Provincial funding.
7. Restated to Preliminary: Decrease 2.5 FTE to balance to Ministry cap; Increase of 5.80 FTE to New Seniors Oral Health per Ministry funding.
8. Restated to Preliminary: Decrease 1.0 FTE, for IT Centralization Transfer.

COMPLEMENT SUMMARY

	2019 Approved Budget	2019 Restated Budget	2020 Preliminary Budget	2020 Preliminary vs. 2019 Restated	
				FTE	%
PUBLIC WORKS					
PW - General Administration	7.00	7.00	7.00	0.00	0.0%
Energy Fleet and Facilities	170.60	170.60	170.60	0.00	0.0%
Engineering Services ^{1,2}	124.33	131.33	131.33	0.00	0.0%
Environmental Services	499.83	499.83	499.83	0.00	0.0%
Transit ³	756.71	756.71	791.71	35.00	4.6%
Transportation Operations & Maintenance ²	397.26	396.26	396.26	0.00	0.0%
Total Public Works	1,955.73	1,961.73	1,996.73	35.00	1.8%

- 1. Approved to Restated: Increase 6.0 FTE from PED to PW Engineering (approved under report FCS19055(a))
- 2. Approved to Restated: Increase 1.0 FTE from Transportation Operations & Maintenance to Engineering (approved under report PW19007)
- 3. Restated to Preliminary: Increase by 35.0 FTE (Year 5 of Transit Strategy- Report PW14015(a))

	2019 Approved Budget	2019 Restated Budget	2020 Preliminary Budget	2020 Preliminary vs. 2019 Restated FTE	2020 Preliminary vs. 2019 Restated %
LEGISLATIVE					
Mayors Office	6.00	6.00	6.00	0.00	0.0%
Ward Budgets	16.00	16.00	16.00	0.00	0.0%
Total Legislative	22.00	22.00	22.00	0.00	0.0%
CITY MANAGER					
Office of the City Auditor	7.00	7.00	7.00	0.00	0.0%
CMO - Admin & Digital Office	3.00	3.00	3.00	0.00	0.0%
Strategic Partnerships & Communications ¹	30.00	32.00	32.00	0.00	0.0%
Human Resources ²	77.00	78.00	78.00	0.00	0.0%
Total City Manager	117.00	120.00	120.00	0.00	0.0%

- 1. Approved to Restated: Increase of 2.0 FTE from REC to SPC (FCS 19055)
- 2. Approved to Restated: Increase 1.0 FTE from Housing to HR (Centralization Report HUR17007/CM17012/FCS17056)

COMPLEMENT SUMMARY

	2019 Approved Budget	2019 Restated Budget	2020 Preliminary Budget	2020 Preliminary vs. 2019 Restated	
				FTE	%
<u>CORPORATE SERVICES</u>					
City Clerk's Office	28.00	28.00	28.00	0.00	0.0%
Corporate Services - Administration	2.00	2.00	2.00	0.00	0.0%
Customer Service ¹	91.47	93.47	93.47	0.00	0.0%
Financial Planning, Admin & Policy ²	82.50	83.00	83.00	0.00	0.0%
Financial Services	80.08	80.08	80.08	0.00	0.0%
Information Technology ³	94.00	108.00	108.00	0.00	0.0%
Legal Services	63.00	63.00	63.00	0.00	0.0%
Total Corporate Services	441.05	457.55	457.55	0.00	0.0%

1. Approved to Restated: Increase of 2.0 FTE from Planning & Economic Development (Licensing and Parking) for Call Handling Consolidation

2. Approved to Restated: Increase of 0.5 FTE from Planning & Economic Development (Transportation Planning & Parking) to Financial Planning Administration & Policy

3. Approved to Restated: Increase of 14.0 FTE from I.T. Centralization; 3 FTE from Recreation; 4 FTE from Hamilton Fire; 4 FTE from Ontario Works; 1 FTE from Public Health; 2 FTE from City Housing

Corporate Financials - Expenditures ¹	1.00	0.00	11.60	11.60	0.0%
---	-------------	-------------	--------------	--------------	-------------

1. Operating Impacts from Capital

TOTAL CITY COMPLEMENT	5,824.69	5,837.27	5,840.17	2.90	0.0%
------------------------------	-----------------	-----------------	-----------------	-------------	-------------

BOARDS & AGENCIES

Library	297.99	297.99	299.28	1.29	0.4%
Police Services ¹	1,147.00	1,147.00	1,147.00	0.00	0.0%
Farmers' Market	4.19	4.19	4.40	0.21	5.0%
Total Boards & Agencies	1,449.18	1,449.18	1,450.68	1.50	0.1%

1. The Police Services budget is approved by the Police Services Board. The Budget is scheduled to be submitted to the Board late December 2019.

APPENDIX 5

**2020
Preliminary
Tax Supported
Operating Budget
Departmental
Budget
Summaries**

PLANNING AND ECONOMIC DEVELOPMENT



DEPARTMENT STRUCTURE

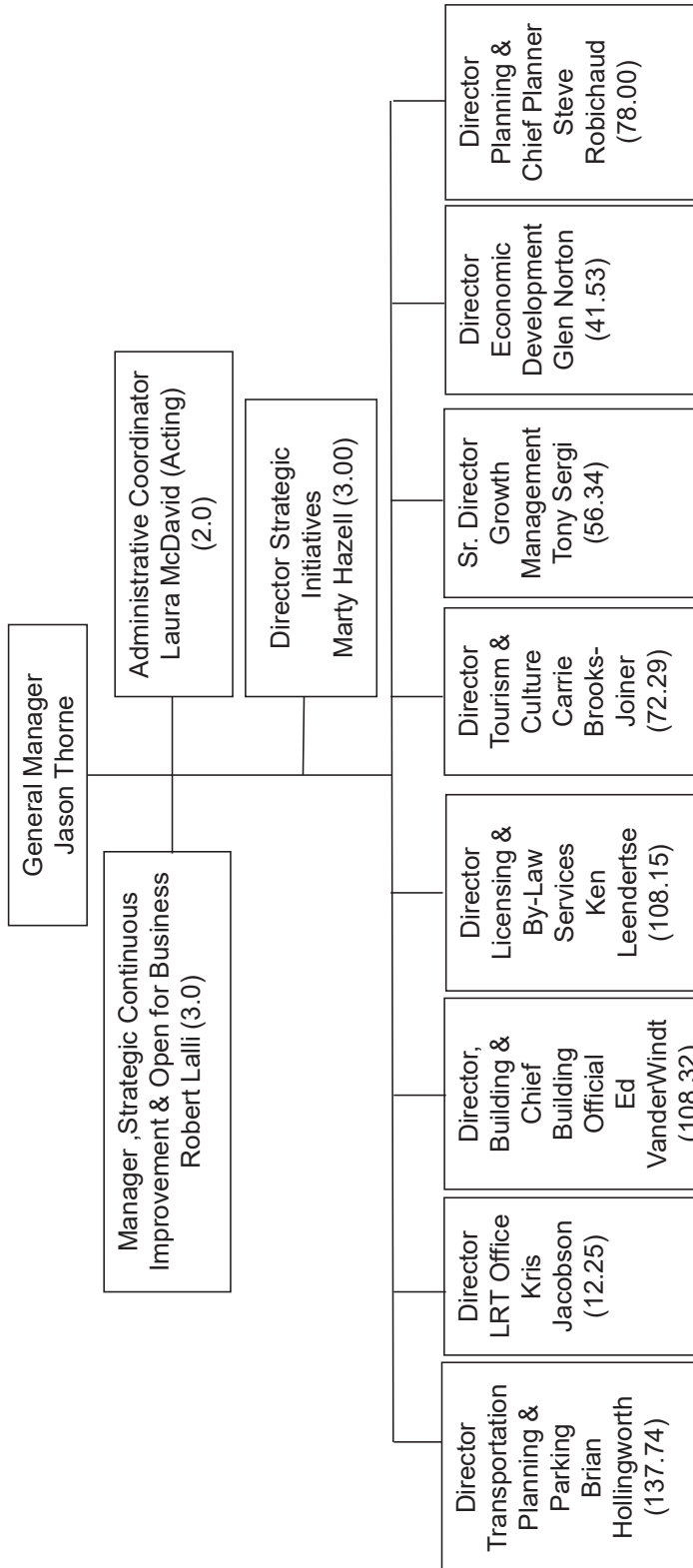

COMPLEMENT (FTE)	MANAGEMENT	OTHER	TOTAL	STAFF/MGT RATIO
2019	39.50	585.12	624.62	14.81:1
2020	39.50	584.12	623.62	14.79:1
CHANGE	0.00	(1.00)	(1.00)	

2020 Preliminary Tax Supported Operating Budget

BY DIVISION

	2019 Restated Gross	2019 Restated Net	2019 Projected Net	2020 Preliminary Gross	2020 Preliminary Net	'20 Prel. Net vs. '19 Rest. Net (\$)	'20 Prel. Net vs. '19 Rest. Net
General Manager	1,193,630	1,021,680	950,070	1,217,250	1,038,090	16,410	1.6%
Transportation, Planning and Parking	16,243,100	2,148,020	1,750,860	16,630,320	2,443,710	295,690	13.8%
Building	14,108,580	1,273,970	1,304,460	14,880,730	1,060,690	(213,280)	(16.7%)
Economic Development	8,584,630	5,359,750	5,424,280	8,837,830	5,421,470	61,720	1.2%
Growth Management	6,900,610	405,240	445,350	6,819,740	590,820	185,580	45.8%
Licensing & By-Law Services	12,775,320	6,615,610	6,879,690	12,670,260	6,645,950	30,340	0.5%
LRT Office	8,606,550	0	0	9,196,740	0	0	0.0%
Planning	9,822,510	3,368,470	3,330,690	8,977,150	3,742,270	373,800	11.1%
Tourism & Culture	10,471,210	9,141,260	9,269,800	10,617,550	9,219,540	78,280	0.9%
Total Planning & Economic Development	88,706,140	29,334,000	29,355,200	89,847,570	30,162,540	828,540	2.8%

BY COST CATEGORY

	2019 Restated Budget	2019 Projected Actual	2020 Preliminary Budget	'20 Preli. vs. '19 Rest. (\$)	'20 Preli. vs. '19 Rest. (%)
EMPLOYEE RELATED COST	66,318,700	66,818,380	67,721,730	1,403,030	2.1%
MATERIAL AND SUPPLY	2,053,010	2,342,070	2,046,810	(6,200)	(0.3%)
VEHICLE EXPENSES	592,840	553,230	609,490	16,650	2.8%
BUILDING AND GROUND	2,475,930	2,522,060	2,259,330	(216,600)	(8.7%)
CONSULTING	1,047,310	1,228,330	1,496,920	449,610	42.9%
CONTRACTUAL	4,149,820	4,667,110	4,178,300	28,480	0.7%
AGENCIES and SUPPORT PAYMENTS	1,336,020	1,528,110	1,336,020	0	0.0%
RESERVES / RECOVERIES	6,256,400	7,963,430	5,424,830	(831,570)	(13.3%)
COST ALLOCATIONS	1,150,860	1,137,390	1,415,220	264,360	23.0%
FINANCIAL	3,235,250	3,151,560	3,358,920	123,670	3.8%
CAPITAL FINANCING	90,000	208,610	0	(90,000)	(100.0%)
TOTAL EXPENDITURES	88,706,140	92,120,290	89,847,570	1,141,430	1.3%
FEES AND GENERAL	(45,925,960)	(48,328,560)	(45,880,650)	45,310	0.1%
GRANTS AND SUBSIDIES	(9,461,520)	(9,807,250)	(10,124,710)	(663,190)	(7.0%)
RESERVES	(1,571,260)	(2,104,840)	(1,183,460)	387,800	24.7%
RECOVERIES FROM CAPITAL	(2,413,400)	(2,524,440)	(2,496,210)	(82,810)	(3.4%)
TOTAL REVENUES	(59,372,140)	(62,765,090)	(59,685,030)	(312,890)	(0.5%)
NET LEVY	29,334,000	29,355,200	30,162,540	828,540	2.8%

2020 Preliminary Tax Supported Operating Budget Multi-Year Budget Outlook

BY DIVISION

	2021 Preliminary Gross	2021 Preliminary Net	2022 Preliminary Gross	2022 Preliminary Net	2023 Preliminary Gross	2023 Preliminary Net
General Manager	1,258,390	1,079,230	1,283,160	1,104,000	1,321,280	1,142,120
Transportation, Planning and Parking	16,917,460	2,518,570	17,152,760	2,424,290	17,370,900	2,350,000
Building	15,147,110	1,188,190	15,442,950	1,181,630	15,730,830	1,207,150
Economic Development	8,980,730	5,534,510	9,103,340	5,633,660	9,220,140	5,727,200
Growth Management	6,859,900	776,120	7,009,020	534,550	7,150,060	677,590
Licensing & By-Law Services	12,953,330	6,812,640	13,212,600	6,953,200	13,456,730	7,076,280
LRT Office	9,309,010	0	9,416,820	0	9,522,050	0
Planning	9,261,900	4,406,920	9,475,890	4,311,570	9,658,880	4,490,470
Tourism & Culture	10,809,550	9,399,050	10,987,200	9,563,990	11,152,230	9,716,030
Total Planning & Economic Development	91,497,380	31,715,230	93,083,740	31,706,890	94,583,100	32,386,840

2020 Preliminary Tax Supported Operating Budget

BY SECTION - GENERAL MANAGER

	2019 Restated Gross	2019 Restated Net	2019 Projected Net	2020 Preliminary Gross	2020 Preliminary Net	'20 Preli. vs. '19 Rest. (\$)	'20 Preli. vs. '19 Rest. (%)
Strategic Initiatives	386,450	386,450	306,070	368,740	368,740	(17,710)	(4.6%)
GM Office	807,180	635,230	644,000	848,510	669,350	34,120	5.4%
Total General Manager	1,193,630	1,021,680	950,070	1,217,250	1,038,090	16,410	1.6%

BY COST CATEGORY - GENERAL MANAGER

	2019 Restated Budget	2019 Projected Actual	2020 Preliminary Budget	'20 Preli. vs. '19 Rest. (\$)	'20 Preli. vs. '19 Rest. (%)
EMPLOYEE RELATED COST	1,226,750	1,134,230	1,256,390	29,640	2.4%
MATERIAL AND SUPPLY	21,080	21,080	21,080	0	0.0%
BUILDING AND GROUND	1,650	1,650	1,310	(340)	(20.6%)
CONTRACTUAL	23,770	23,770	22,310	(1,460)	(6.1%)
RESERVES / RECOVERIES	96,190	40,080	106,970	10,780	11.2%
COST ALLOCATIONS	(175,810)	(175,810)	(190,810)	(15,000)	(8.5%)
TOTAL EXPENDITURES	1,193,630	1,045,000	1,217,250	23,620	2.0%
RESERVES	(50,000)	(50,000)	(50,000)	0	0.0%
RECOVERIES FROM CAPITAL	(121,950)	(44,930)	(129,160)	(7,210)	(5.9%)
TOTAL REVENUES	(171,950)	(94,930)	(179,160)	(7,210)	(4.2%)
NET LEVY	1,021,680	950,070	1,038,090	16,410	1.6%

TRANSPORTATION
PLANNING AND PARKING

DIVISION STRUCTURE

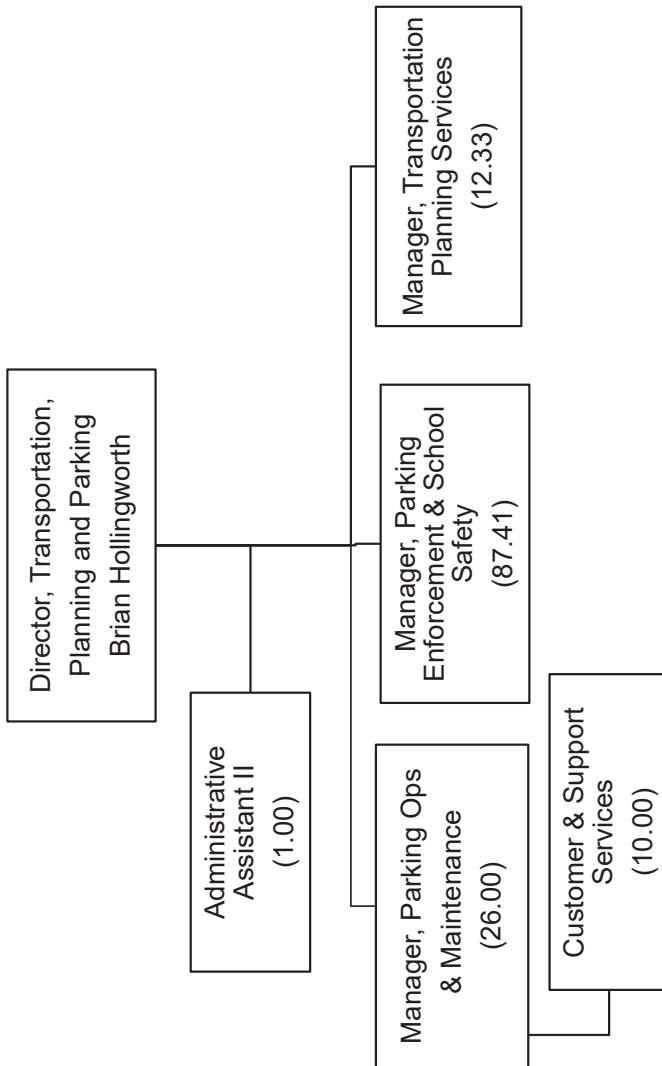

COMPLEMENT (FTE)	MANAGEMENT	OTHER	TOTAL	STAFF/MGT RATIO
2019	4.00	132.74	136.74	33.19:1
2020	4.00	133.74	137.74	33.44:1
CHANGE	0.00	1.00	1.00	

2020 Preliminary Tax Supported Operating Budget

BY SECTION

	2019 Restated Gross	2019 Restated Net	2019 Projected Net	2020 Preliminary Gross	2020 Preliminary Net	'20 Preli. vs. '19 Rest. (\$)	'20 Preli. vs. '19 Rest. (%)
Transportation Planning	1,548,730	1,548,730	1,250,110	1,667,220	1,164,000	(384,730)	(24.8%)
Director's Office TPP	138,610	138,610	285,990	159,750	159,750	21,140	15.3%
Hamilton Municipal Parking System	12,800,110	(1,294,970)	(1,320,310)	12,908,010	(775,380)	519,590	(40.1%)
School Crossing	1,755,650	1,755,650	1,535,070	1,895,340	1,895,340	139,690	8.0%
Total Transportation, Planning and Parking	16,243,100	2,148,020	1,750,860	16,630,320	2,443,710	295,690	13.8%

BY COST CATEGORY

	2019 Restated Budget	2019 Projected Actual	2020 Preliminary Budget	'20 Preli. vs. '19 Rest. (\$)	'20 Preli. vs. '19 Rest. (%)
EMPLOYEE RELATED COST	9,244,070	9,296,320	9,651,260	407,190	4.4%
MATERIAL AND SUPPLY	306,790	452,790	340,610	33,820	11.0%
VEHICLE EXPENSES	193,280	193,560	205,170	11,890	6.2%
BUILDING AND GROUND	1,048,310	1,016,540	807,160	(241,150)	(23.0%)
CONSULTING	0	4,000	0	0	0.0%
CONTRACTUAL	1,776,600	1,664,650	1,778,290	1,690	0.1%
RESERVES / RECOVERIES	1,500,510	2,184,080	1,552,130	51,620	3.4%
COST ALLOCATIONS	774,380	696,460	783,270	8,890	1.1%
FINANCIAL	1,399,160	1,440,420	1,512,430	113,270	8.1%
CAPITAL FINANCING	0	21,130	0	0	0.0%
TOTAL EXPENDITURES	16,243,100	16,969,950	16,630,320	387,220	2.4%
FEES AND GENERAL	(14,095,080)	(15,148,410)	(14,069,830)	25,250	0.2%
RESERVES	0	(70,010)	0	0	0.0%
RECOVERIES FROM CAPITAL	0	(670)	(116,780)	(116,780)	(100.0%)
TOTAL REVENUES	(14,095,080)	(15,219,090)	(14,186,610)	(91,530)	(0.6%)
NET LEVY	2,148,020	1,750,860	2,443,710	295,690	13.8%

DIVISION STRUCTURE

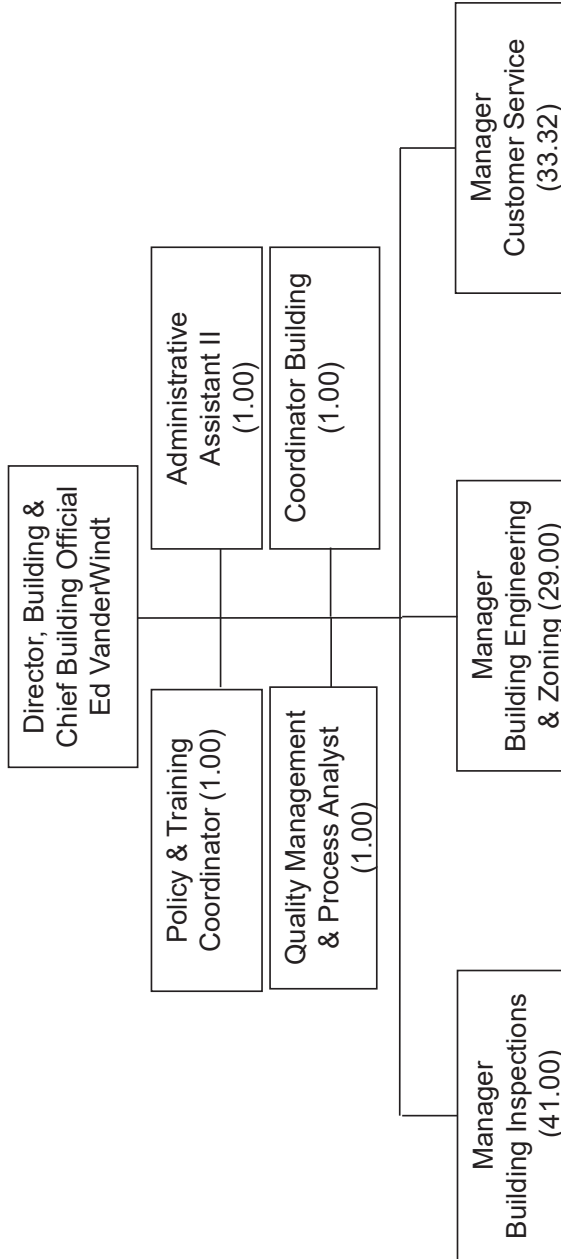

COMPLEMENT (FTE)	MANAGEMENT	OTHER	TOTAL	STAFF/MGT RATIO
2019	4.00	104.32	108.32	26.08
2020	4.00	104.32	108.32	26.08
CHANGE	0.00	0.00	0.00	

BUILDING

2020 Preliminary Tax Supported Operating Budget

BY SECTION

	2019 Restated Gross	2019 Restated Net	2019 Projected Net	2020 Preliminary Gross	2020 Preliminary Net	'20 Prel. vs. '19 Rest. (\$)	'20 Prel. vs. '19 Rest. (%)
Administration - Building Serv	284,000	280,000	271,780	282,150	278,150	(1,850)	(0.7%)
Building Inspections	623,680	623,680	628,380	617,370	617,370	(6,310)	(1.0%)
Engineering & Zoning Services	919,830	182,380	179,400	1,324,810	(57,660)	(240,040)	(131.6%)
Enterprise Model	12,060,650	(32,510)	0	12,437,660	4,090	36,600	(112.6%)
Plan Examination Sec	220,420	220,420	224,900	218,740	218,740	(1,680)	(0.8%)
Total Building	14,108,580	1,273,970	1,304,460	14,880,730	1,060,690	(213,280)	(16.7%)

BY COST CATEGORY

	2019 Restated Budget	2019 Projected Actual	2020 Preliminary Budget	'20 Prel. vs. '19 Rest. (\$)	'20 Prel. vs. '19 Rest. (%)
EMPLOYEE RELATED COST	12,139,780	12,128,510	12,405,710	265,930	2.2%
MATERIAL AND SUPPLY	185,620	253,760	182,680	(2,940)	(1.6%)
VEHICLE EXPENSES	132,210	100,400	127,400	(4,810)	(3.6%)
BUILDING AND GROUND	16,800	32,960	17,220	420	2.5%
CONSULTING	0	11,870	0	0	0.0%
CONTRACTUAL	43,750	109,570	40,010	(3,740)	(8.5%)
RESERVES / RECOVERIES	881,590	935,640	1,282,780	401,190	45.5%
COST ALLOCATIONS	682,390	682,390	798,490	116,100	17.0%
FINANCIAL	26,440	82,170	26,440	0	0.0%
TOTAL EXPENDITURES	14,108,580	14,337,270	14,880,730	772,150	5.5%
FEES AND GENERAL	(12,834,610)	(13,033,300)	(13,820,040)	(985,430)	(7.7%)
RECOVERIES FROM CAPITAL	0	490	0	0	0.0%
TOTAL REVENUES	(12,834,610)	(13,032,810)	(13,820,040)	(985,430)	(7.7%)
NET LEVY	1,273,970	1,304,460	1,060,690	(213,280)	(16.7%)

ECONOMIC DEVELOPMENT

DIVISION STRUCTURE

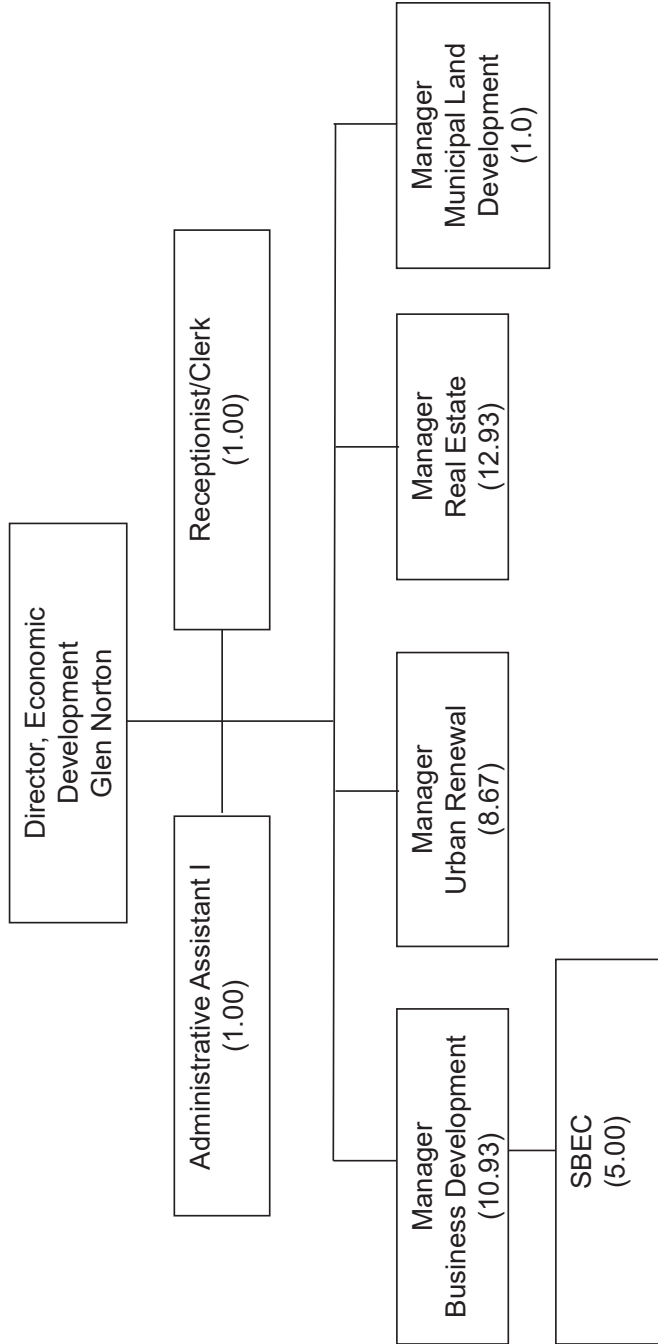

COMPLEMENT (FTE)	MANAGEMENT	OTHER	TOTAL	STAFF/AMGT RATIO
2019	5.00	36.53	41.53	7.31:1
2020	5.00	36.53	41.53	7.31:1
CHANGE	0.00	0.00	0.00	

2020 Preliminary Tax Supported Operating Budget

BY SECTION

	2019 Restated Gross	2019 Restated Net	2019 Projected Net	2020 Preliminary Gross	2020 Preliminary Net	'20 Preli. vs. '19 Rest. (\$)	'20 Preli. vs. '19 Rest. (%)
Business Development	3,462,740	3,074,510	3,257,270	3,555,940	3,147,710	73,200	2.4%
Real Estate	2,279,240	962,250	847,870	2,407,870	920,060	(42,190)	(4.4%)
Urban Renewal	2,842,650	1,322,990	1,319,140	2,874,020	1,353,700	30,710	2.3%
Total Economic Development	8,584,630	5,359,750	5,424,280	8,837,830	5,421,470	61,720	1.2%

BY COST CATEGORY

	2019 Restated Budget	2019 Projected Actual	2020 Preliminary Budget	'20 Preli. vs. '19 Rest. (\$)	'20 Preli. vs. '19 Rest. (%)
EMPLOYEE RELATED COST	5,402,210	5,841,520	5,613,870	211,660	3.9%
MATERIAL AND SUPPLY	250,260	294,410	246,300	(3,960)	(1.6%)
BUILDING AND GROUND	10,520	15,020	7,900	(2,620)	(24.9%)
CONSULTING	31,000	42,650	31,000	0	0.0%
CONTRACTUAL	510,680	542,300	517,180	6,500	1.3%
AGENCIES and SUPPORT PAYMENTS	1,057,100	1,244,010	1,057,100	0	0.0%
RESERVES / RECOVERIES	196,200	572,540	227,370	31,170	15.9%
COST ALLOCATIONS	316,200	312,150	331,140	14,940	4.7%
FINANCIAL	810,460	610,410	805,970	(4,490)	(0.6%)
TOTAL EXPENDITURES	8,584,630	9,475,010	8,837,830	253,200	2.9%
FEES AND GENERAL	(1,529,900)	(2,034,560)	(1,646,690)	(116,790)	(7.6%)
GRANTS AND SUBSIDIES	(495,840)	(768,900)	(495,840)	0	0.0%
RESERVES	(1,083,160)	(1,083,160)	(1,108,160)	(25,000)	(2.3%)
RECOVERIES FROM CAPITAL	(115,980)	(164,110)	(165,670)	(49,690)	(42.8%)
TOTAL REVENUES	(3,224,880)	(4,050,730)	(3,416,360)	(191,480)	(5.9%)
NET LEVY	5,359,750	5,424,280	5,421,470	61,720	1.2%

GROWTH MANAGEMENT

DIVISION STRUCTURE

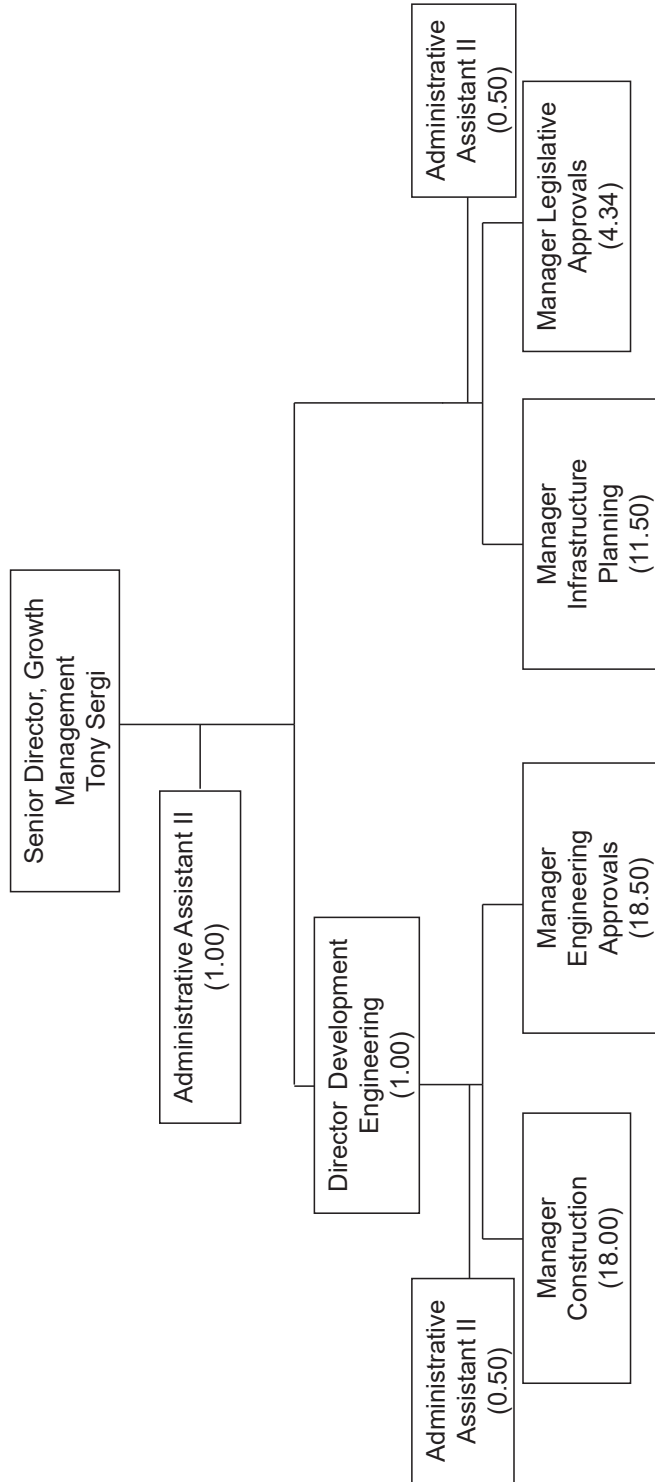

COMPLEMENT (FTE)	MANAGEMENT	OTHER	TOTAL	STAFF/MGT RATIO
2019	6.00	50.34	56.34	8.39:1
2020	6.00	50.34	56.34	8.39:1
CHANGE	0.00	0.00	0.00	

2020 Preliminary Tax Supported Operating Budget

BY SECTION

	2019 Restated Gross	2019 Restated Net	2019 Projected Net	2020 Preliminary Gross	2020 Preliminary Net	'20 Preli. vs. '19 Rest. (\$)	'20 Preli. vs. '19 Rest. (%)
Infrastructure Planning	2,225,960	1,107,150	1,062,880	2,321,180	1,242,710	135,560	12.2%
Grading & Construction Services	730,920	65,920	124,780	745,200	130,230	64,310	97.6%
Growth Management	3,943,730	(767,830)	(742,310)	3,753,360	(782,120)	(14,290)	1.9%
Total Growth Management	6,900,610	405,240	445,350	6,819,740	590,820	185,580	45.8%

BY COST CATEGORY

	2019 Restated Budget	2019 Projected Actual	2020 Preliminary Budget	'20 Preli. vs. '19 Rest. (\$)	'20 Preli. vs. '19 Rest. (%)
EMPLOYEE RELATED COST	6,331,590	6,087,330	6,503,420	171,830	2.7%
MATERIAL AND SUPPLY	156,320	147,570	156,320	0	0.0%
VEHICLE EXPENSES	30,490	30,490	34,150	3,660	12.0%
BUILDING AND GROUND	9,130	9,130	8,460	(670)	(7.3%)
CONSULTING	70,000	70,000	70,000	0	0.0%
CONTRACTUAL	10,270	269,810	10,270	0	0.0%
RESERVES / RECOVERIES	953,270	1,797,700	586,420	(366,850)	(38.5%)
COST ALLOCATIONS	(677,630)	(677,630)	(566,470)	111,160	16.4%
FINANCIAL	17,170	12,920	17,170	0	0.0%
CAPITAL FINANCING	0	30,000	0	0	0.0%
TOTAL EXPENDITURES	6,900,610	7,777,320	6,819,740	(80,870)	(1.2%)
FEEES AND GENERAL	(5,866,560)	(6,385,940)	(5,910,450)	(43,890)	(0.7%)
RESERVES	(220,000)	(464,920)	0	220,000	100.0%
RECOVERIES FROM CAPITAL	(408,810)	(481,110)	(318,470)	90,340	22.1%
TOTAL REVENUES	(6,495,370)	(7,331,970)	(6,228,920)	266,450	4.1%
NET LEVY	405,240	445,350	590,820	185,580	45.8%

LICENSING AND BY-LAW SERVICES

DIVISION STRUCTURE

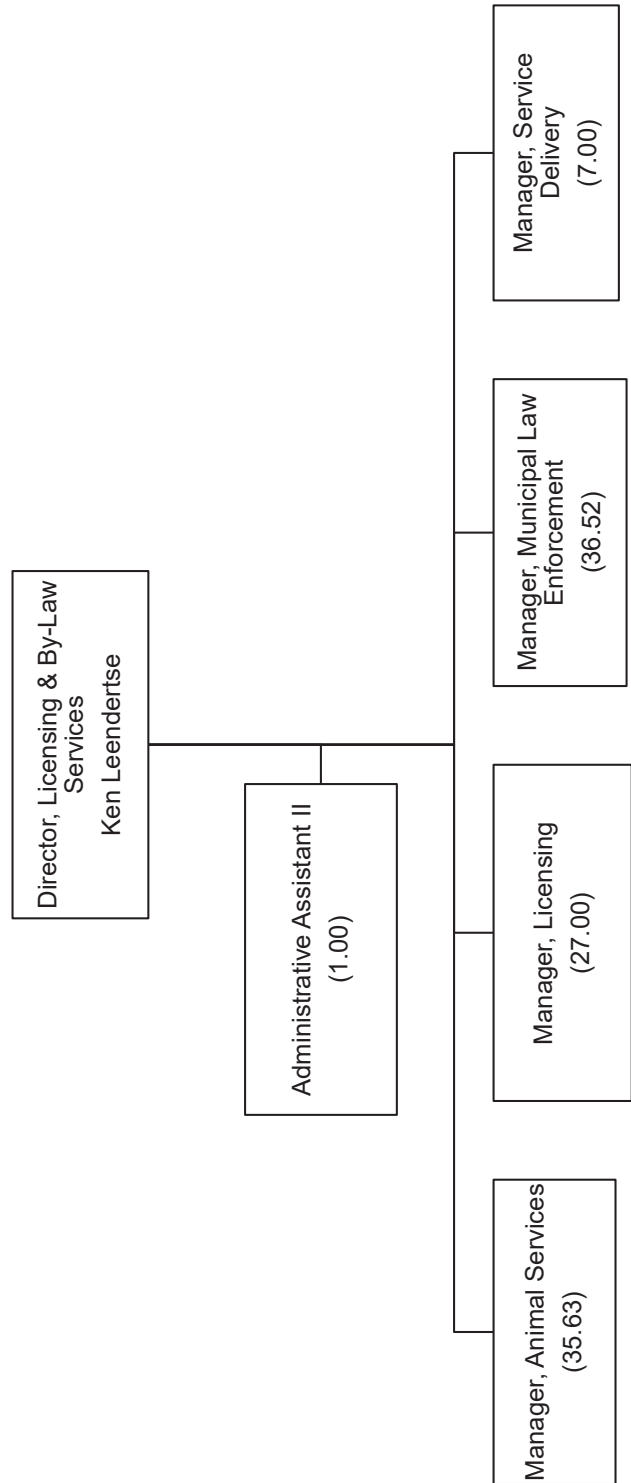

COMPLEMENT (FTE)	MANAGEMENT	OTHER	TOTAL	STAFF/AMGT RATIO
2019	5.00	105.15	110.15	21.03:1
2020	5.00	103.15	108.15	20.63:1
CHANGE	0.00	(2.00)	(2.00)	

2020 Preliminary Tax Supported Operating Budget

BY SECTION

	2019 Restated Gross	2019 Restated Net	2019 Projected Net	2020 Preliminary Gross	2020 Preliminary Net	'20 Preli. vs. '19 Rest. (\$)	'20 Preli. vs. '19 Rest. (%)
Service Delivery	651,400	651,400	637,330	655,280	655,280	3,880	0.6%
Animal Services	4,306,330	2,765,330	2,830,780	4,392,930	2,851,930	86,600	3.1%
Directors Office L&BL	593,710	593,710	715,630	604,410	604,410	10,700	1.8%
Licensing	3,087,610	(315,680)	(687,870)	2,894,810	(594,180)	(278,500)	88.2%
Municipal Law Enforcement	4,136,270	2,920,850	3,383,820	4,122,830	3,128,510	207,660	7.1%
Total Licensing & By-Law Services	12,775,320	6,615,610	6,879,690	12,670,260	6,645,950	30,340	0.5%

BY COST CATEGORY

	2019 Restated Budget	2019 Projected Actual	2020 Preliminary Budget	'20 Preli. vs. '19 Rest. (\$)	'20 Preli. vs. '19 Rest. (%)
EMPLOYEE RELATED COST	10,409,800	10,624,030	10,332,650	(77,150)	(0.7%)
MATERIAL AND SUPPLY	283,250	330,320	277,630	(5,620)	(2.0%)
VEHICLE EXPENSES	230,750	222,790	236,190	5,440	2.4%
BUILDING AND GROUND	502,380	526,920	501,800	(580)	(0.1%)
CONSULTING	2,500	47,500	27,500	25,000	1,000.0%
CONTRACTUAL	146,220	328,520	154,690	8,470	5.8%
AGENCIES and SUPPORT PAYMENTS	0	550	0	0	0.0%
RESERVES / RECOVERIES	708,510	707,600	726,100	17,590	2.5%
COST ALLOCATIONS	317,710	383,790	331,500	13,790	4.3%
FINANCIAL	84,200	102,100	82,200	(2,000)	(2.4%)
CAPITAL FINANCING	90,000	157,480	0	(90,000)	(100.0%)
TOTAL EXPENDITURES	12,775,320	13,431,600	12,670,260	(105,060)	(0.8%)
	0	0	0	0	
FEES AND GENERAL	(5,818,610)	(6,043,250)	(5,804,310)	14,300	0.2%
GRANTS AND SUBSIDIES	(147,000)	(209,990)	(220,000)	(73,000)	(49.7%)
RESERVES	(194,100)	(268,470)	0	194,100	100.0%
RECOVERIES FROM CAPITAL	0	(30,200)	0	0	0.0%
TOTAL REVENUES	(6,159,710)	(6,551,910)	(6,024,310)	135,400	2.2%
NET LEVY	6,615,610	6,879,690	6,645,950	30,340	0.5%

LRT OFFICE

DIVISION STRUCTURE

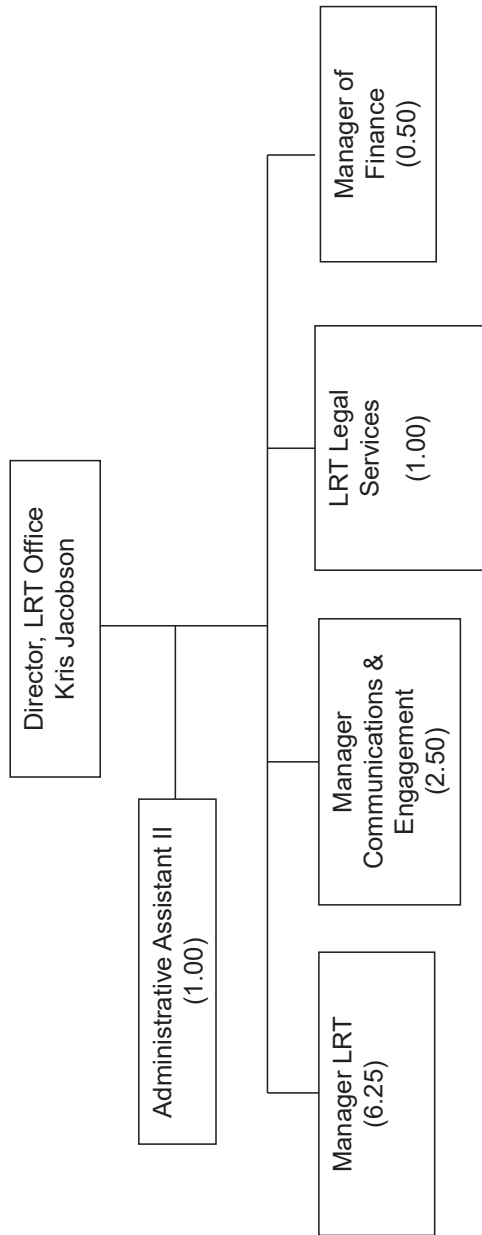

COMPLEMENT (FTE)	MANAGEMENT	OTHER	TOTAL	STAFF/AMGT RATIO
2019	3.50	8.75	12.25	2.5:1
2020	3.50	8.75	12.25	2.5:1
CHANGE	0.00	0.00	0.00	

2020 Preliminary Tax Supported Operating Budget

BY SECTION

	2019 Restated Gross	2019 Restated Net	2019 Projected Net	2020 Preliminary Gross	2020 Preliminary Net	'20 Prel. vs. '19 Rest. (\$)	'20 Prel. vs. '19 Rest. (%)
LRT Office	8,606,550	0	0	9,196,740	0	0	0.0%
Total LRT Office	8,606,550	0	0	9,196,740	0	0	0.0%

BY COST CATEGORY

	2019 Restated Budget	2019 Projected Actual	2020 Preliminary Budget	'20 Prel. vs. '19 Rest. (\$)	'20 Prel. vs. '19 Rest. (%)
EMPLOYEE RELATED COST	6,206,860	6,212,860	6,368,580	161,720	2.6%
MATERIAL AND SUPPLY	41,170	46,510	39,490	(1,680)	(4.1%)
BUILDING AND GROUND	103,600	103,600	103,210	(390)	(0.4%)
CONSULTING	815,430	817,530	1,241,040	425,610	52.2%
CONTRACTUAL	636,480	639,480	635,000	(1,480)	(0.2%)
RESERVES / RECOVERIES	36,510	20,070	39,360	2,850	7.8%
COST ALLOCATIONS	0	0	1,000	1,000	100.0%
FINANCIAL	766,500	766,500	769,060	2,560	0.3%
TOTAL EXPENDITURES	8,606,550	8,606,550	9,196,740	590,190	6.9%
GRANTS AND SUBSIDIES	(8,606,550)	(8,606,550)	(9,196,740)	(590,190)	(6.9%)
TOTAL REVENUES	(8,606,550)	(8,606,550)	(9,196,740)	(590,190)	(6.9%)
NET LEVY	0	0	0	0	0.0%

PLANNING

DIVISION STRUCTURE

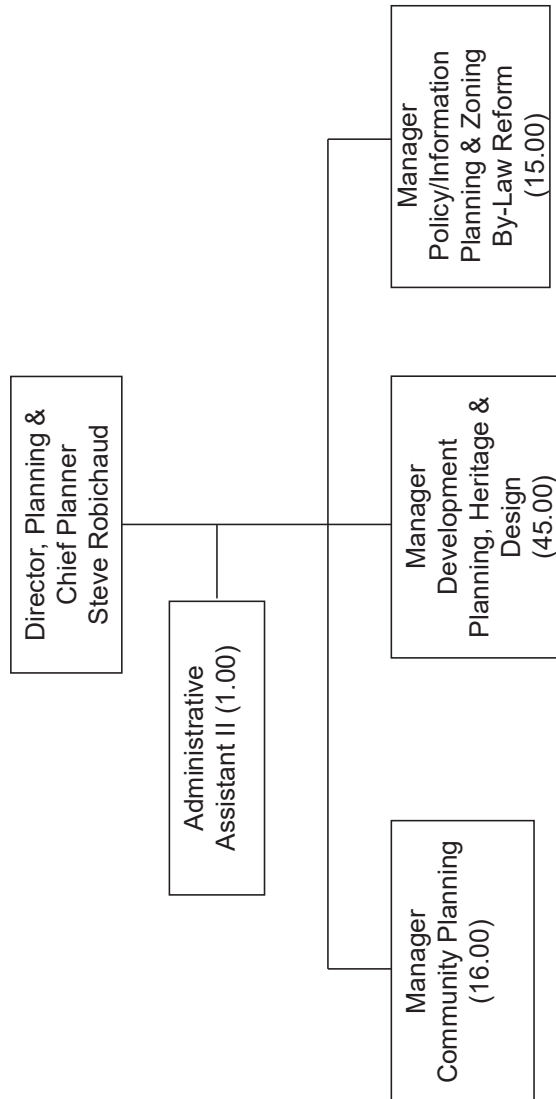

COMPLEMENT (FTE)	MANAGEMENT	OTHER	TOTAL	STAFF/MGT RATIO
2019	4.00	74.00	78.00	18.5:1
2020	4.00	74.00	78.00	18.5:1
CHANGE	0.00	0.00	0.00	

2020 Preliminary Tax Supported Operating Budget

BY SECTION

	2019 Restated Gross	2019 Restated Net	2019 Projected Net	2020 Preliminary Gross	2020 Preliminary Net	'20 Preli. vs. '19 Rest. (\$)	'20 Preli. vs. '19 Rest. (%)
Community Planning	1,736,660	1,732,660	1,710,890	1,752,380	1,748,380	15,720	0.9%
Planning & Committee of Adjmt	6,523,310	1,388,560	1,371,260	5,663,150	1,744,940	356,380	25.7%
Policy Planning, Zoning & Data	1,562,540	247,250	248,540	1,561,620	248,950	1,700	0.7%
Total Planning	9,822,510	3,368,470	3,330,690	8,977,150	3,742,270	373,800	11.1%

BY COST CATEGORY

	2019 Restated Budget	2019 Projected Actual	2020 Preliminary Budget	'20 Preli. vs. '19 Rest. (\$)	'20 Preli. vs. '19 Rest. (%)
EMPLOYEE RELATED COST	7,987,000	7,457,530	8,097,660	110,660	1.4%
MATERIAL AND SUPPLY	216,020	224,970	216,020	0	0.0%
VEHICLE EXPENSES	1,500	1,500	1,500	0	0.0%
BUILDING AND GROUND	12,900	14,180	12,850	(50)	(0.4%)
CONSULTING	114,380	218,380	114,380	0	0.0%
CONTRACTUAL	76,490	111,280	76,490	0	0.0%
AGENCIES and SUPPORT PAYMENTS	91,670	95,000	91,670	0	0.0%
RESERVES / RECOVERIES	1,417,940	1,210,590	427,540	(990,400)	(69.8%)
COST ALLOCATIONS	(152,160)	(142,130)	(117,730)	34,430	22.6%
FINANCIAL	56,770	56,770	56,770	0	0.0%
TOTAL EXPENDITURES	9,822,510	9,248,070	8,977,150	(845,360)	(8.6%)
FEES AND GENERAL	(5,112,240)	(4,847,780)	(3,898,210)	1,214,030	23.7%
RESERVES	(24,000)	(154,890)	(24,000)	0	0.0%
RECOVERIES FROM CAPITAL	(1,317,800)	(914,710)	(1,312,670)	5,130	0.4%
TOTAL REVENUES	(6,454,040)	(5,917,380)	(5,234,880)	1,219,160	18.9%
NET LEVY	3,368,470	3,330,690	3,742,270	373,800	11.1%

TOURISM AND CULTURE

DIVISION STRUCTURE

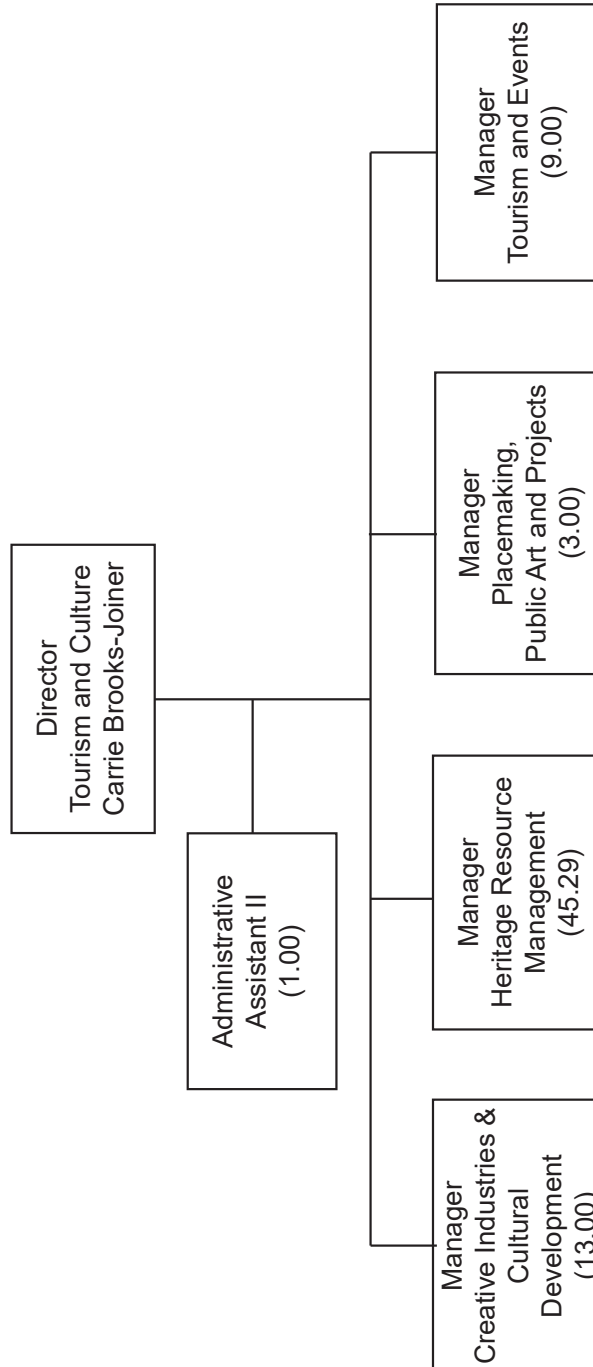

COMPLEMENT (FTE)	MANAGEMENT	OTHER	TOTAL	STAFF/MGT RATIO
2019	5.00	67.29	72.29	13.46:1
2020	5.00	67.29	72.29	13.46:1
CHANGE	0.00	0.00	0.00	

2020 Preliminary Tax Supported Operating Budget

BY SECTION

	2019 Restated Gross	2019 Restated Net	2019 Projected Net	2020 Preliminary Gross	2020 Preliminary Net	'20 Preli. vs. '19 Rest. (\$)	'20 Preli. vs. '19 Rest. (%)
Tourism and Events	9,778,030	8,448,080	8,538,280	9,909,390	8,511,380	63,300	0.7%
Directors Office T&C	693,180	693,180	731,520	708,160	708,160	14,980	2.2%
Total Tourism & Culture	10,471,210	9,141,260	9,269,800	10,617,550	9,219,540	78,280	0.9%

BY COST CATEGORY

	2019 Restated Budget	2019 Projected Actual	2020 Preliminary Budget	'20 Preli. vs. '19 Rest. (\$)	'20 Preli. vs. '19 Rest. (%)
EMPLOYEE RELATED COST	7,370,640	8,036,050	7,492,190	121,550	1.6%
MATERIAL AND SUPPLY	592,500	570,670	566,680	(25,820)	(4.4%)
VEHICLE EXPENSES	4,610	4,490	5,080	470	10.2%
BUILDING AND GROUND	770,640	802,060	799,420	28,780	3.7%
CONSULTING	14,000	16,400	13,000	(1,000)	(7.1%)
CONTRACTUAL	925,560	977,730	944,060	18,500	2.0%
AGENCIES and SUPPORT PAYMENTS	187,250	188,550	187,250	0	0.0%
RESERVES / RECOVERIES	465,680	495,130	476,160	10,480	2.3%
COST ALLOCATIONS	65,780	58,170	44,830	(20,950)	(31.8%)
FINANCIAL	74,550	80,270	88,880	14,330	19.2%
TOTAL EXPENDITURES	10,471,210	11,229,520	10,617,550	146,340	1.4%
FEES AND GENERAL	(668,960)	(835,320)	(731,120)	(62,160)	(9.3%)
GRANTS AND SUBSIDIES	(212,130)	(221,810)	(212,130)	0	0.0%
RESERVES	0	(13,390)	(1,300)	(1,300)	(100.0%)
RECOVERIES FROM CAPITAL	(448,860)	(889,200)	(453,460)	(4,600)	(1.0%)
TOTAL REVENUES	(1,329,950)	(1,959,720)	(1,398,010)	(68,060)	(5.1%)
NET LEVY	9,141,260	9,269,800	9,219,540	78,280	0.9%

HEALTHY AND SAFE COMMUNITIES



DEPARTMENT STRUCTURE

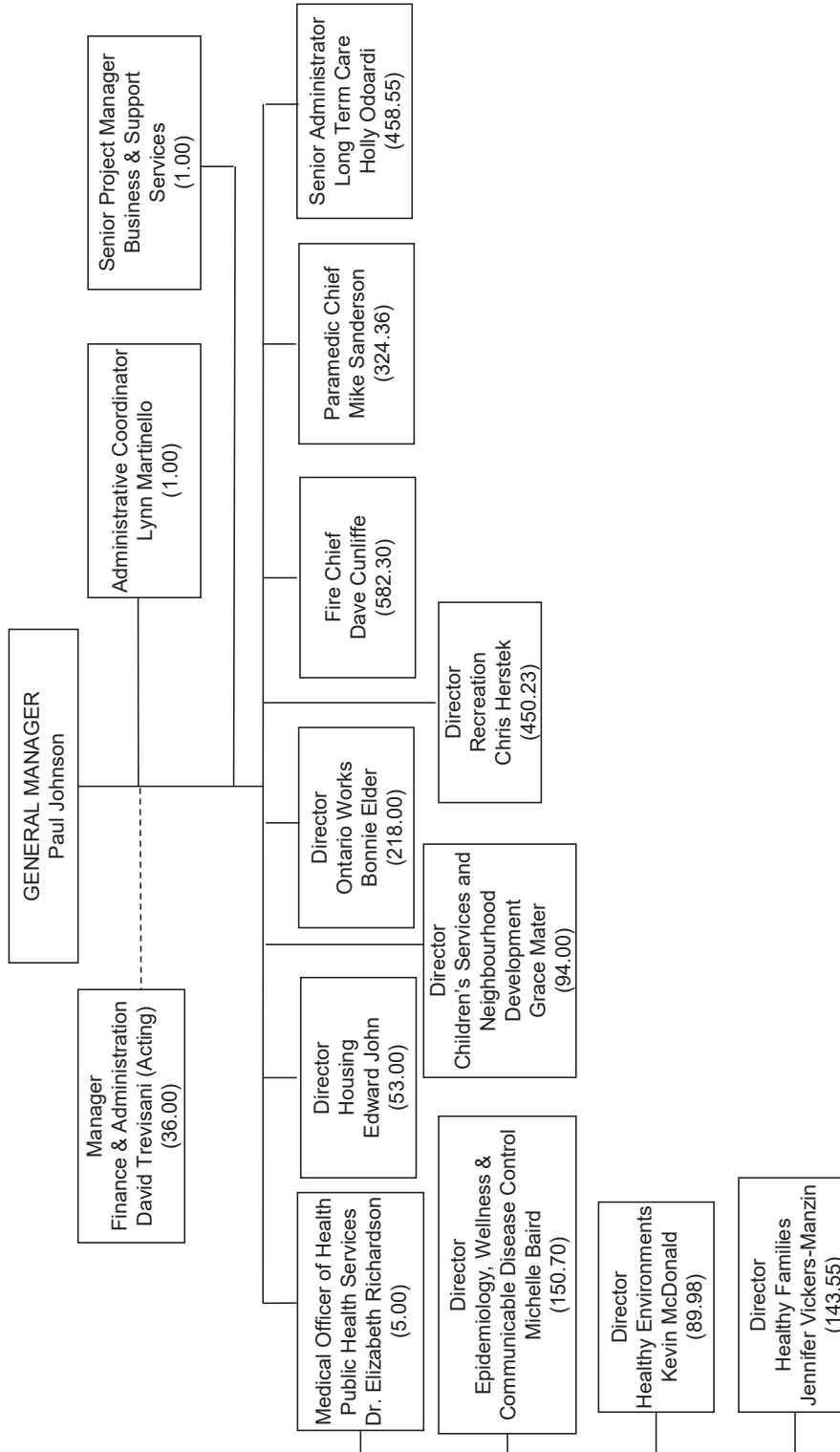

COMPLEMENT (FTE)	MANAGEMENT	OTHER	TOTAL	STAFF/MGT RATIO
2019	86.00	2,565.37	2,651.37	29.83:1
2020	85.00	2,523.67	2,608.67	29.69:1
CHANGE	(1.00)	(41.70)	(42.70)	

2020 Preliminary Tax Supported Operating Budget

BY DIVISION

	2019 Restated Gross	2019 Restated Net	2019 Projected Net	2020 Preliminary Gross	2020 Preliminary Net	'20 Prel. Net vs. '19 Rest. Net (\$)	'20 Prel. Net vs. '19 Rest. Net
HSC Administration	3,100,430	2,760,720	2,919,010	3,140,320	2,796,820	36,100	1.3%
Children's Services and Neighbourhood Dev.	93,659,390	8,675,010	8,543,680	93,604,240	10,981,620	2,306,610	26.6%
Ontario Works	153,082,450	11,918,050	11,288,700	143,509,570	13,043,380	1,125,330	9.4%
Housing Services	91,231,810	45,068,420	41,635,250	91,230,470	45,279,830	211,410	0.5%
Long Term Care	46,319,570	13,472,300	13,336,740	46,813,860	14,081,410	609,110	4.5%
Recreation	53,185,920	33,503,780	33,718,260	53,724,390	34,181,800	678,020	2.0%
Hamilton Fire Department	92,511,720	92,083,970	92,103,520	94,239,730	93,689,710	1,605,740	1.7%
Hamilton Paramedic Service	51,327,330	23,794,770	24,500,820	52,801,160	25,108,770	1,314,000	5.5%
Public Health Services	51,522,580	12,356,500	12,546,620	53,714,350	13,472,990	1,116,490	9.0%
Total Healthy and Safe Communities	635,941,200	243,633,520	240,592,600	632,778,090	252,636,330	9,002,810	3.7%

BY COST CATEGORY

	2019 Restated Budget	2019 Projected Actual	2020 Preliminary Budget	'20 Preli. vs. '19 Rest. (\$)	'20 Preli. vs. '19 Rest. (%)
EMPLOYEE RELATED COST	281,404,400	279,483,560	283,980,340	2,575,940	0.9%
MATERIAL AND SUPPLY	12,209,140	13,105,830	12,120,410	(88,730)	(0.7%)
VEHICLE EXPENSES	2,617,860	2,639,160	2,696,510	78,650	3.0%
BUILDING AND GROUND	15,837,370	15,434,020	15,508,250	(329,120)	(2.1%)
CONSULTING	67,240	92,300	92,240	25,000	37.2%
CONTRACTUAL	8,247,570	8,281,540	8,935,780	688,210	8.3%
AGENCIES and SUPPORT PAYMENTS	290,248,700	282,190,650	282,988,060	(7,260,640)	(2.5%)
RESERVES / RECOVERIES	16,656,500	16,819,520	17,897,510	1,241,010	7.5%
COST ALLOCATIONS	5,771,810	5,873,280	5,655,150	(116,660)	(2.0%)
FINANCIAL	1,861,870	1,909,040	1,885,100	23,230	1.2%
CAPITAL FINANCING	1,018,740	1,019,760	1,018,740	0	0.0%
TOTAL EXPENDITURES	635,941,200	626,848,660	632,778,090	(3,163,110)	(0.5%)
FEES AND GENERAL	(37,492,720)	(38,440,610)	(38,198,110)	(705,390)	(1.9%)
GRANTS AND SUBSIDIES	(353,017,870)	(343,693,530)	(340,835,880)	12,181,990	3.5%
RESERVES	(932,450)	(2,883,630)	(377,450)	555,000	59.5%
RECOVERIES FROM CAPITAL	(864,580)	(1,238,270)	(730,300)	134,280	15.5%
TOTAL REVENUES	(392,307,620)	(386,256,040)	(380,141,740)	12,165,880	3.1%
NET LEVY	243,633,520	240,592,600	252,636,330	9,002,810	3.7%

2020 Preliminary Tax Supported Operating Budget Multi-Year Budget Outlook

BY DIVISION

	2021	2021	2022	2022	2023	2023
	Preliminary	Preliminary	Preliminary	Preliminary	Preliminary	Preliminary
	Gross	Net	Gross	Net	Gross	Net
HSC Administration	3,234,750	2,889,770	3,313,070	2,965,660	3,381,800	3,032,010
Children's Services and Neighbourhood Dev.	94,338,440	12,621,480	94,496,430	12,719,190	94,652,020	12,815,410
Ontario Works	140,619,240	13,575,430	141,090,750	14,046,360	141,537,070	14,492,090
Housing Services	93,115,110	48,336,640	93,474,730	50,695,970	93,526,320	52,387,890
Long Term Care	47,754,180	15,086,070	48,676,115	15,777,760	49,597,815	16,464,590
Recreation	54,888,250	34,966,670	55,826,821	35,518,710	56,747,221	36,044,850
Hamilton Fire Department	96,965,980	96,406,810	99,674,810	99,106,300	102,459,400	101,881,380
Hamilton Paramedic Service	53,978,030	26,071,260	55,023,740	26,515,870	56,076,440	27,031,860
Public Health Services	54,421,490	15,581,220	55,237,890	16,435,490	56,056,400	17,255,590
Total Healthy and Safe Communities	639,315,470	265,535,350	646,814,356	273,781,310	654,034,486	281,405,670
Budget Increase	1.0%	5.1%	1.2%	3.1%	1.1%	2.8%

2020 Preliminary Tax Supported Operating Budget

BY SECTION - ADMINISTRATION

	2019 Restated Gross	2019 Restated Net	2019 Projected Net	2020 Preliminary Gross	2020 Preliminary Net	'20 Preli. vs. '19 Rest. (\$)	'20 Preli. vs. '19 Rest. (%)
HSC - Finance & Administration	2,344,720	2,041,060	1,958,030	2,385,450	2,078,000	36,940	1.8%
General Manager's Office	755,710	719,660	960,980	754,870	718,820	(840)	(0.1%)
Total HSC Administration	3,100,430	2,760,720	2,919,010	3,140,320	2,796,820	36,100	1.3%

BY COST CATEGORY - ADMINISTRATION

	2019 Restated Budget	2019 Projected Actual	2020 Preliminary Budget	'20 Preli. vs. '19 Rest. (\$)	'20 Preli. vs. '19 Rest. (%)
EMPLOYEE RELATED COST	2,806,460	2,996,800	2,854,200	47,740	1.7%
MATERIAL AND SUPPLY	35,690	69,360	35,690	0	0.0%
BUILDING AND GROUND	5,250	5,740	5,390	140	2.7%
CONTRACTUAL	1,580	2,990	1,580	0	0.0%
RESERVES / RECOVERIES	230,560	231,280	222,180	(8,380)	(3.6%)
COST ALLOCATIONS	20,890	20,890	21,280	390	1.9%
TOTAL EXPENDITURES	3,100,430	3,327,060	3,140,320	39,890	1.3%
GRANTS AND SUBSIDIES	(339,710)	(328,860)	(343,500)	(3,790)	(1.1%)
RECOVERIES FROM CAPITAL	0	(79,190)	0	0	0.0%
TOTAL REVENUES	(339,710)	(408,050)	(343,500)	(3,790)	(1.1%)
NET LEVY	2,760,720	2,919,010	2,796,820	36,100	1.3%

CHILDREN'S SERVICES
AND NEIGHBOURHOOD
DEVELOPMENT

DIVISION STRUCTURE

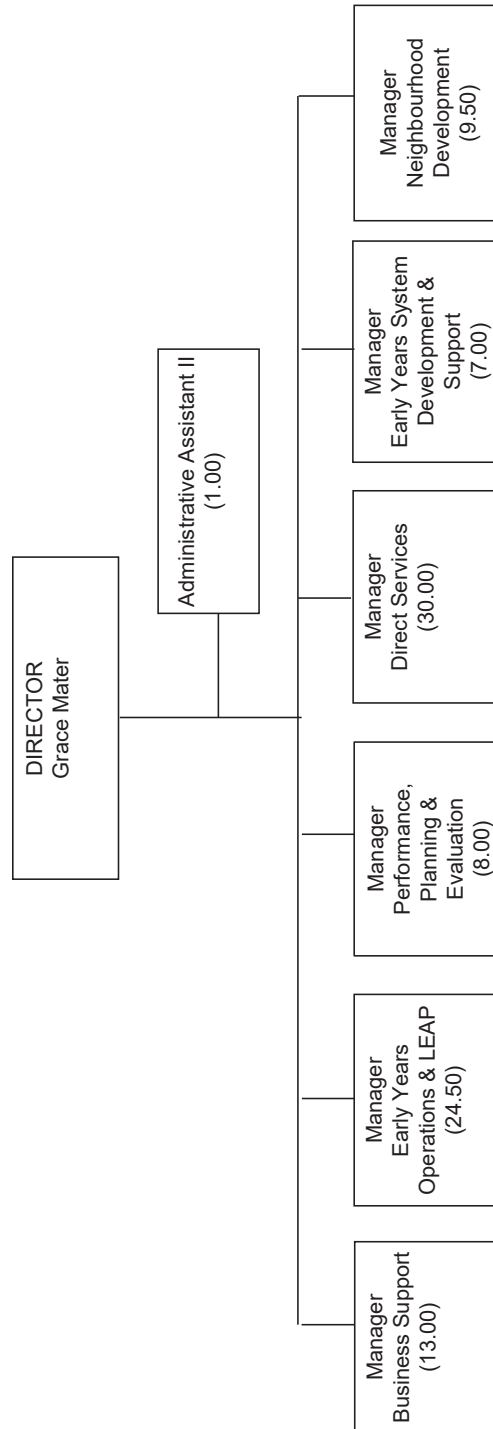

COMPLEMENT (FTE)	MANAGEMENT	OTHER	TOTAL	STAFF/MGT RATIO
2019	7.00	87.00	94.00	12.43 : 1
2020	7.00	87.00	94.00	12.43 : 1
CHANGE	0.00	0.00	0.00	

2020 Preliminary Tax Supported Operating Budget

BY SECTION

	2019 Restated Gross	2019 Restated Net	2019 Projected Net	2020 Preliminary Gross	2020 Preliminary Net	'20 Preli. vs. '19 Rest. (\$)	'20 Preli. vs. '19 Rest. (%)
Neighbourhoods & Community	1,774,800	1,734,100	1,610,780	1,858,270	1,716,030	(18,070)	(1.0%)
CSND Administration	412,340	(15,090)	0	427,860	(15,680)	(590)	3.9%
Early Years & Child Care	89,625,430	6,709,800	6,700,790	89,806,830	9,026,830	2,317,030	34.5%
Home Management	1,846,820	246,200	232,110	1,511,280	254,440	8,240	3.3%
Total Children's Services and Neighbourhood Dev.	93,659,390	8,675,010	8,543,680	93,604,240	10,981,620	2,306,610	26.6%

BY COST CATEGORY

	2019 Restated Budget	2019 Projected Actual	2020 Preliminary Budget	'20 Preli. vs. '19 Rest. (\$)	'20 Preli. vs. '19 Rest. (%)
EMPLOYEE RELATED COST	9,672,450	9,257,900	9,777,170	104,720	1.1%
MATERIAL AND SUPPLY	1,013,540	736,260	694,240	(319,300)	(31.5%)
BUILDING AND GROUND	45,700	46,670	45,710	10	0.0%
CONTRACTUAL	617,530	464,280	546,260	(71,270)	(11.5%)
AGENCIES and SUPPORT PAYMENTS	81,691,670	82,761,190	81,773,940	82,270	0.1%
RESERVES / RECOVERIES	245,260	(356,450)	377,660	132,400	54.0%
COST ALLOCATIONS	319,940	320,260	337,220	17,280	5.4%
FINANCIAL	53,300	46,060	52,040	(1,260)	(2.4%)
TOTAL EXPENDITURES	93,659,390	93,276,160	93,604,240	(55,150)	(0.1%)
FEES AND GENERAL	(2,886,850)	(3,146,790)	(3,416,520)	(529,670)	(18.3%)
GRANTS AND SUBSIDIES	(81,332,530)	(80,818,910)	(78,996,100)	2,336,430	2.9%
RESERVES	(765,000)	(765,000)	(210,000)	555,000	72.5%
RECOVERIES FROM CAPITAL	0	(1,790)	0	0	0.0%
TOTAL REVENUES	(84,984,380)	(84,732,490)	(82,622,620)	2,361,760	2.8%
NET LEVY	8,675,010	8,543,680	10,981,620	2,306,610	26.6%

ONTARIO WORKS

DIVISION STRUCTURE

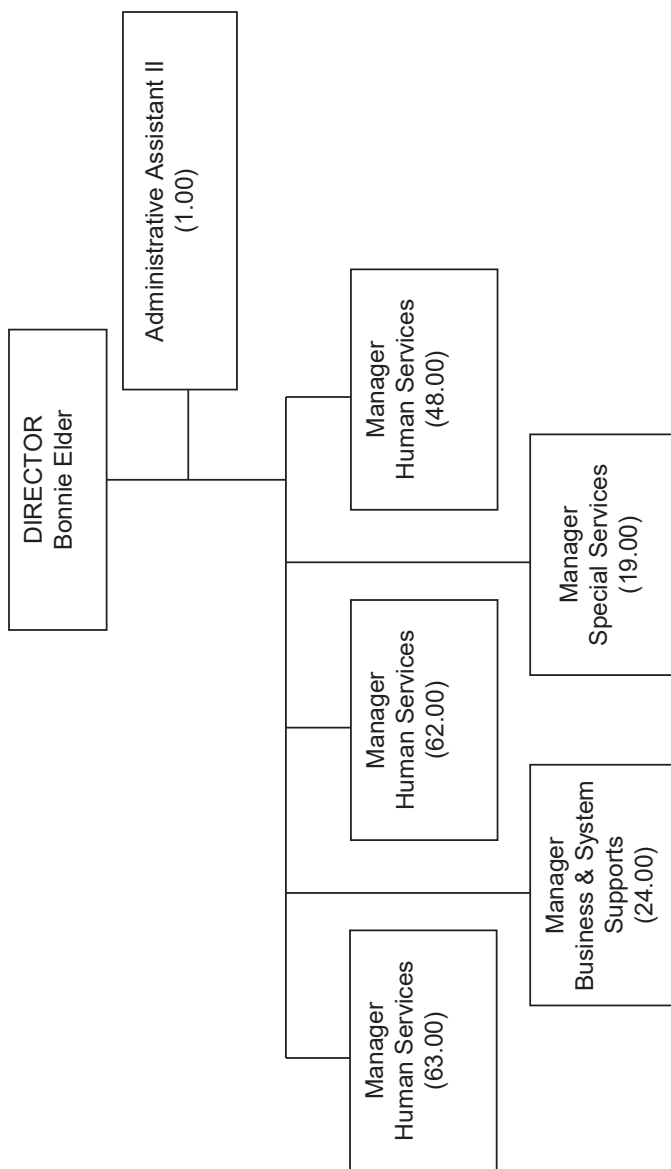

COMPLEMENT (FTE)	MANAGEMENT	OTHER	TOTAL	STAFF/MGT RATIO
2019	7.00	255.00	262.00	36.43:1
2020	6.00	212.00	218.00	35.33:1
CHANGE	(1.00)	(43.00)	(44.00)	

2020 Preliminary Tax Supported Operating Budget

BY SECTION

	2019 Restated Gross	2019 Restated Net	2019 Projected Net	2020 Preliminary Gross	2020 Preliminary Net	'20 Preli. vs. '19 Rest. (\$)	'20 Preli. vs. '19 Rest. (%)
Client Benefits/Spec Supports	121,499,880	1,065,230	1,021,710	113,999,740	1,084,860	19,630	1.8%
OW Admin	31,582,570	10,852,820	10,266,990	29,509,830	11,958,520	1,105,700	10.2%
Total Ontario Works	153,082,450	11,918,050	11,288,700	143,509,570	13,043,380	1,125,330	9.4%

BY COST CATEGORY

	2019 Restated Budget	2019 Projected Actual	2020 Preliminary Budget	'20 Preli. vs. '19 Rest. (\$)	'20 Preli. vs. '19 Rest. (%)
EMPLOYEE RELATED COST	25,010,310	23,595,710	23,364,240	(1,646,070)	(6.6%)
MATERIAL AND SUPPLY	780,100	864,330	696,640	(83,460)	(10.7%)
VEHICLE EXPENSES	10,000	6,630	5,800	(4,200)	(42.0%)
BUILDING AND GROUND	2,361,180	2,334,640	2,300,420	(60,760)	(2.6%)
CONTRACTUAL	175,730	140,400	48,890	(126,840)	(72.2%)
AGENCIES and SUPPORT PAYMENTS	123,082,270	116,800,160	115,486,270	(7,596,000)	(6.2%)
RESERVES / RECOVERIES	427,000	430,720	445,110	18,110	4.2%
COST ALLOCATIONS	912,320	912,860	869,290	(43,030)	(4.7%)
FINANCIAL	323,540	334,660	292,910	(30,630)	(9.5%)
CAPITAL FINANCING	0	1,030	0	0	0.0%
TOTAL EXPENDITURES	153,082,450	145,421,140	143,509,570	(9,572,880)	(6.3%)
FEES AND GENERAL	(2,020,420)	(1,982,280)	(1,909,230)	111,190	5.5%
GRANTS AND SUBSIDIES	(139,143,980)	(132,137,420)	(128,556,960)	10,587,020	7.6%
RECOVERIES FROM CAPITAL	0	(12,740)	0	0	0.0%
TOTAL REVENUES	(141,164,400)	(134,132,440)	(130,466,190)	10,698,210	7.6%
NET LEVY	11,918,050	11,288,700	13,043,380	1,125,330	9.4%

HOUSING SERVICES

DIVISION STRUCTURE

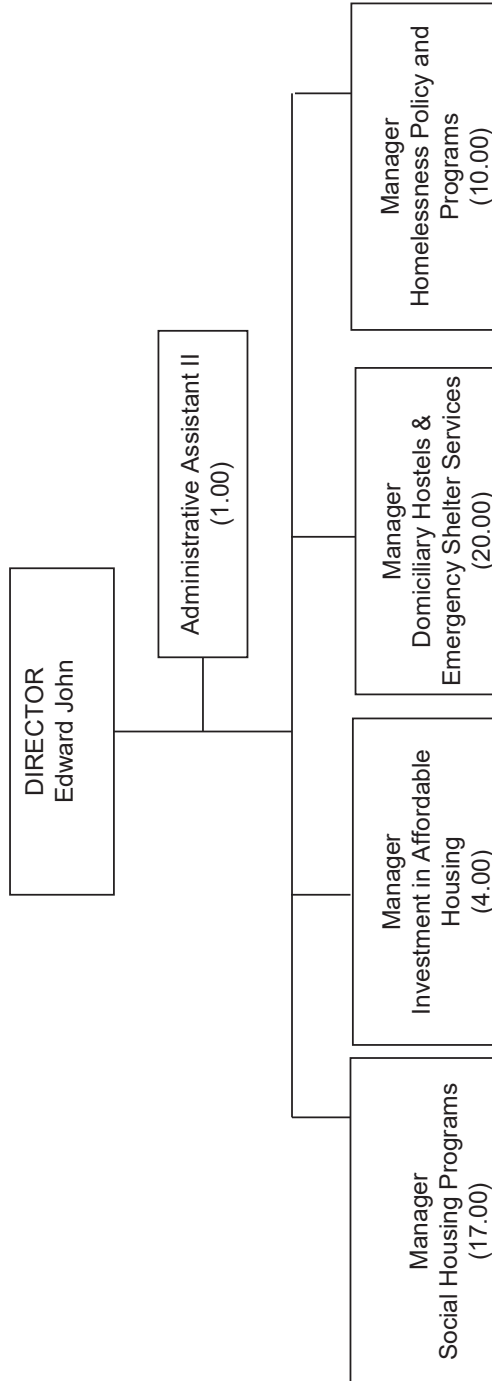

COMPLEMENT (FTE)	MANAGEMENT	OTHER	TOTAL	STAFF/AMGT RATIO
2019	5.00	49.00	54.00	9.80:1
2020	5.00	48.00	53.00	9.60:1
CHANGE	0.00	(1.00)	(1.00)	

2020 Preliminary Tax Supported Operating Budget

BY SECTION

	2019 Restated Gross	2019 Restated Net	2019 Projected Net	2020 Preliminary Gross	2020 Preliminary Net	'20 Preli. vs. '19 Rest. (\$)	'20 Preli. vs. '19 Rest. (%)
Housing Services Administration	722,230	595,470	597,230	532,830	532,830	(62,640)	(10.5%)
Affordable Housing	7,696,920	4,727,130	4,555,820	7,626,570	4,839,490	112,360	2.4%
Homelessness	32,023,350	4,688,920	4,710,780	32,020,720	4,804,750	115,830	2.5%
Social Housing	50,789,310	35,056,900	31,771,420	51,050,350	35,102,760	45,860	0.1%
Total Housing Services	91,231,810	45,068,420	41,635,250	91,230,470	45,279,830	211,410	0.5%

BY COST CATEGORY

	2019 Restated Budget	2019 Projected Actual	2020 Preliminary Budget	'20 Preli. vs. '19 Rest. (\$)	'20 Preli. vs. '19 Rest. (%)
EMPLOYEE RELATED COST	6,277,330	5,581,130	6,059,290	(218,040)	(3.5%)
MATERIAL AND SUPPLY	219,270	325,335	230,220	10,950	5.0%
BUILDING AND GROUND	174,680	167,880	182,290	7,610	4.4%
CONSULTING	0	52,300	0	0	0.0%
CONTRACTUAL	310,090	76,940	311,480	1,390	0.4%
AGENCIES and SUPPORT PAYMENTS	84,316,670	82,106,920	84,557,530	240,860	0.3%
RESERVES / RECOVERIES	62,270	400,570	75,920	13,650	21.9%
COST ALLOCATIONS	(201,410)	(106,230)	(271,370)	(69,960)	(34.7%)
FINANCIAL	72,910	77,430	85,110	12,200	16.7%
TOTAL EXPENDITURES	91,231,810	88,682,275	91,230,470	(1,340)	(0.0%)
FEES AND GENERAL	(15,000)	(344,050)	(15,000)	0	0.0%
GRANTS AND SUBSIDIES	(45,116,340)	(44,639,170)	(45,037,870)	78,470	0.2%
RESERVES	(167,450)	(913,300)	(167,450)	0	0.0%
RECOVERIES FROM CAPITAL	(864,580)	(1,150,500)	(730,300)	134,280	15.5%
TOTAL REVENUES	(46,163,370)	(47,047,020)	(45,950,620)	212,750	0.5%
NET LEVY	45,068,420	41,635,250	45,279,830	211,410	0.5%

LONG TERM CARE
– Macassa Lodge

DIVISION STRUCTURE

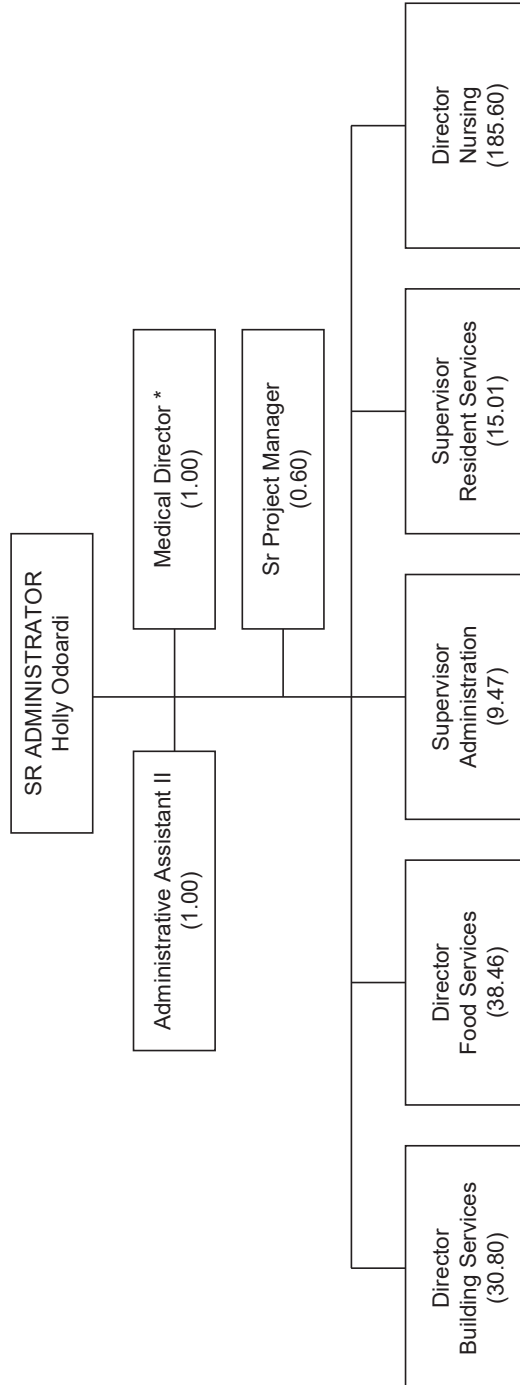

COMPLEMENT (FTE)	MANAGEMENT	OTHER	TOTAL	STAFF/MGT RATIO
2019	8.00	273.94	281.94	34.24:1
2020	8.00	273.94	281.94	34.24:1
CHANGE	0.00	0.00	0.00	

LONG TERM CARE
– Wentworth Lodge

DIVISION STRUCTURE

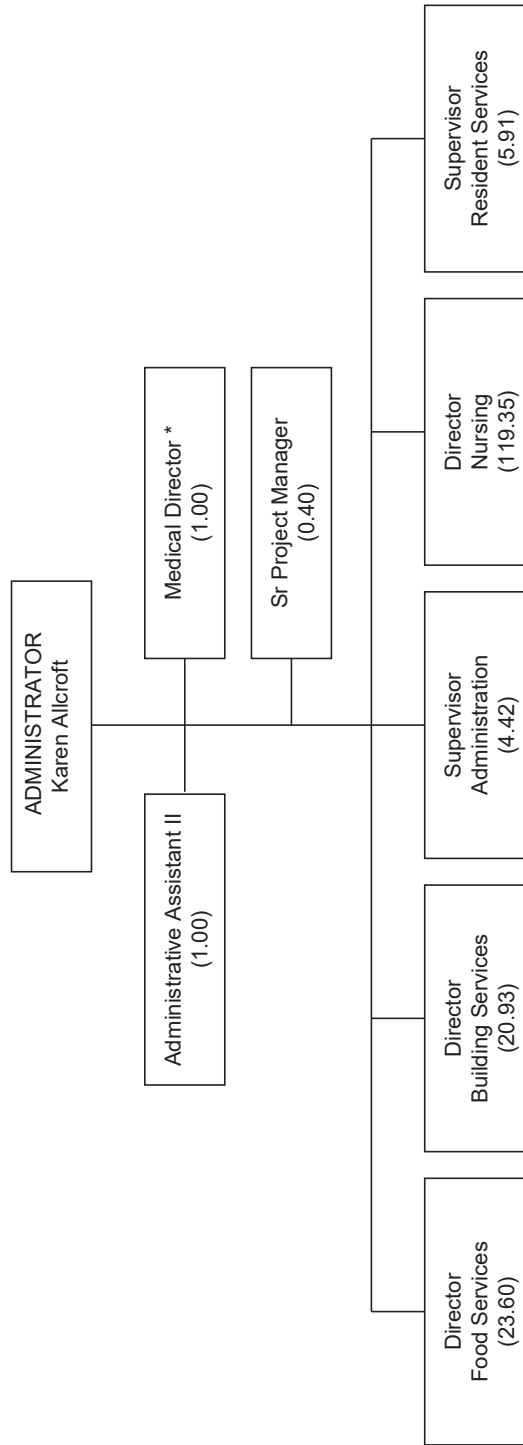

* Not included in complement

COMPLEMENT (FTE)	MANAGEMENT	OTHER	TOTAL	STAFF/MGT RATIO
2019	6.00	170.61	176.61	28.44:1
2020	6.00	170.61	176.61	28.44:1
CHANGE	0.00	0.00	0.00	

2020 Preliminary Tax Supported Operating Budget

BY SECTION

	2019 Restated Gross	2019 Restated Net	2019 Projected Net	2020 Preliminary Gross	2020 Preliminary Net	'20 Preli. vs. '19 Rest. (\$)	'20 Preli. vs. '19 Rest. (%)
Macassa Lodge	28,815,430	7,948,800	7,950,090	29,076,280	8,436,540	487,740	6.1%
Wentworth Lodge	17,504,140	5,523,500	5,386,650	17,737,580	5,644,870	121,370	2.2%
Total Long Term Care	46,319,570	13,472,300	13,336,740	46,813,860	14,081,410	609,110	4.5%

BY COST CATEGORY

	2019 Restated Budget	2019 Projected Actual	2020 Preliminary Budget	'20 Preli. vs. '19 Rest. (\$)	'20 Preli. vs. '19 Rest. (%)
EMPLOYEE RELATED COST	40,087,570	40,223,070	40,477,920	390,350	1.0%
MATERIAL AND SUPPLY	3,076,380	2,938,090	3,103,800	27,415	0.9%
BUILDING AND GROUND	1,381,840	1,288,260	1,381,020	(820)	(0.1%)
CONTRACTUAL	685,760	701,370	732,980	47,215	6.9%
AGENCIES and SUPPORT PAYMENTS	111,900	107,810	124,630	12,730	11.4%
RESERVES / RECOVERIES	913,830	947,780	928,350	14,515	1.6%
COST ALLOCATIONS	0	90	2,880	2,880	100.0%
FINANCIAL	62,290	65,630	62,290	0	0.0%
TOTAL EXPENDITURES	46,319,570	46,272,100	46,813,860	494,285	1.1%
FEES AND GENERAL	(11,284,900)	(11,245,740)	(11,534,530)	(249,630)	(2.2%)
GRANTS AND SUBSIDIES	(21,562,360)	(21,689,630)	(21,197,920)	364,445	1.7%
TOTAL REVENUES	(32,847,260)	(32,935,370)	(32,732,450)	114,815	0.3%
NET LEVY	13,472,300	13,336,740	14,081,410	609,110	4.5%

RECREATION

DIVISION STRUCTURE

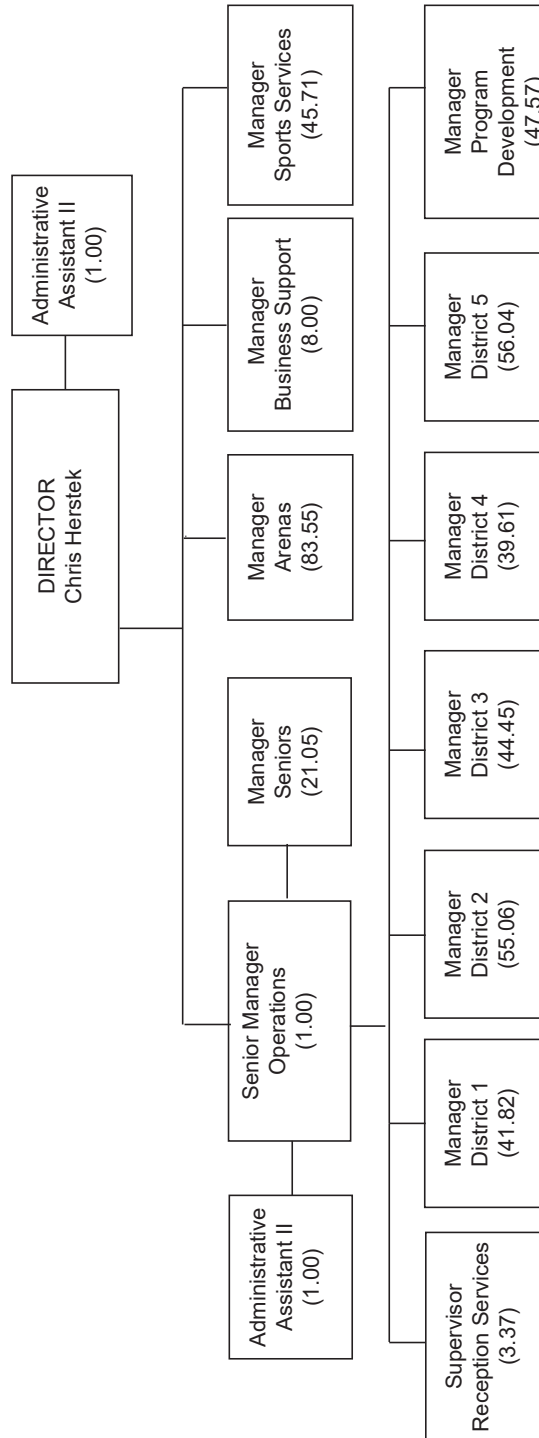

COMPLEMENT (FTE)	MANAGEMENT	OTHER	TOTAL	STAFF/MGT RATIO
2019	12.00	438.23	450.23	36.52:1
2020	12.00	438.23	450.23	36.52:1
CHANGE	0.00	0.00	0.00	

2020 Preliminary Tax Supported Operating Budget

BY SECTION

	2019 Restated Gross	2019 Restated Net	2019 Projected Net	2020 Preliminary Gross	2020 Preliminary Net	'20 Preli. vs. '19 Rest. (\$)	'20 Preli. vs. '19 Rest. (%)
City Wide Services & Programs	9,749,070	4,710,050	4,788,350	9,459,670	4,425,290	(284,760)	(6.0%)
Recreation Administration	(43,450)	(43,450)	321,560	(36,110)	(36,110)	7,340	(16.9%)
Recreation Operations	43,480,300	28,837,180	28,608,350	44,300,830	29,792,620	955,440	3.3%
Total Recreation	53,185,920	33,503,780	33,718,260	53,724,390	34,181,800	678,020	2.0%

BY COST CATEGORY

	2019 Restated Budget	2019 Projected Actual	2020 Preliminary Budget	'20 Preli. vs. '19 Rest. (\$)	'20 Preli. vs. '19 Rest. (%)
EMPLOYEE RELATED COST	30,931,930	31,018,020	31,384,700	452,770	1.5%
MATERIAL AND SUPPLY	1,830,950	1,962,590	1,849,400	18,450	1.0%
VEHICLE EXPENSES	641,280	689,180	652,530	11,250	1.8%
BUILDING AND GROUND	8,352,090	8,231,470	8,056,160	(295,926)	(3.5%)
CONTRACTUAL	3,014,700	3,100,650	3,007,050	(7,653)	(0.3%)
AGENCIES and SUPPORT PAYMENTS	966,740	1,062,190	966,240	(500)	(0.1%)
RESERVES / RECOVERIES	6,387,590	6,476,810	6,746,140	358,550	5.6%
COST ALLOCATIONS	8,500	13,150	11,380	2,880	33.9%
FINANCIAL	567,180	607,780	565,830	(1,350)	(0.2%)
CAPITAL FINANCING	484,960	484,960	484,960	0	0.0%
TOTAL EXPENDITURES	53,185,920	53,646,800	53,724,390	538,471	1.0%
FEES AND GENERAL	(19,303,740)	(19,347,460)	(19,115,590)	188,149	1.0%
GRANTS AND SUBSIDIES	(378,400)	(440,080)	(427,000)	(48,600)	(12.8%)
RESERVES	0	(141,000)	0	0	0.0%
TOTAL REVENUES	(19,682,140)	(19,928,540)	(19,542,590)	139,549	0.7%
NET LEVY	33,503,780	33,718,260	34,181,800	678,020	2.0%

HAMILTON FIRE DEPARTMENT

DIVISION STRUCTURE

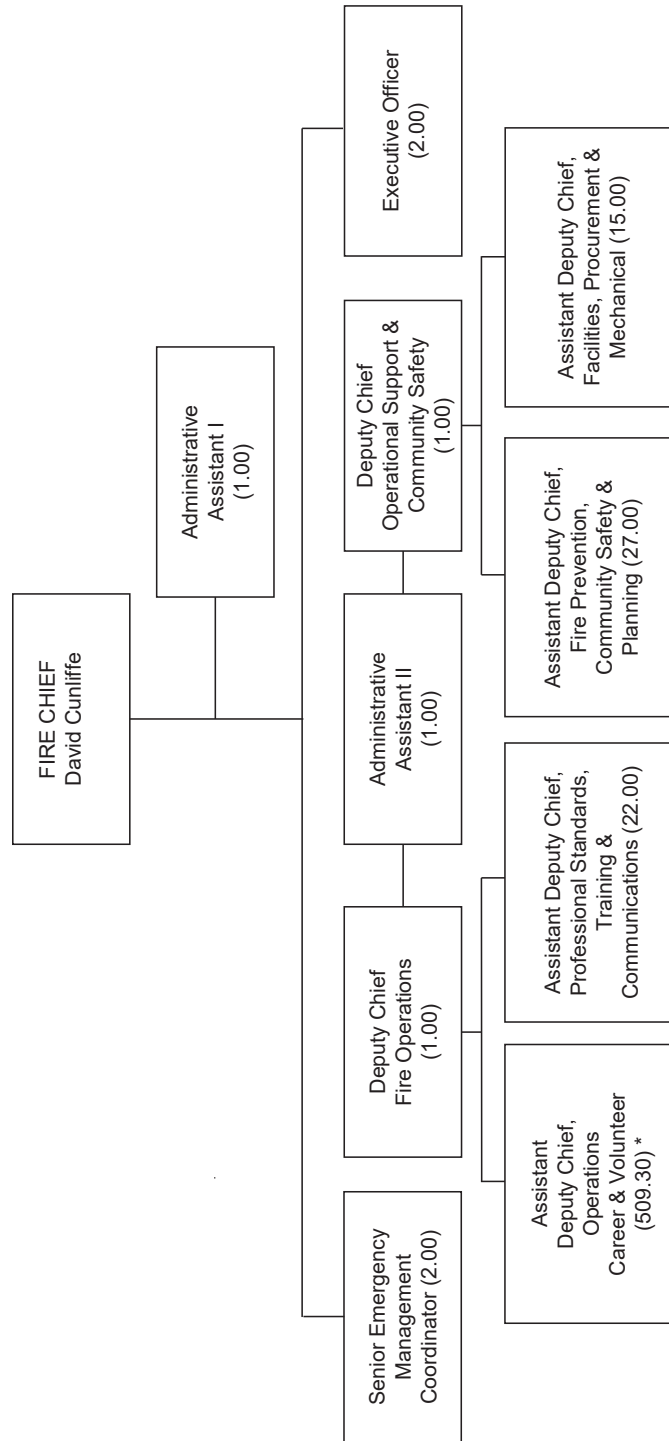

COMPLEMENT (FTE)	MANAGEMENT	OTHER	TOTAL	STAFF/AMGT RATIO
2019	9.00	573.30	582.30	63.70:1
2020	9.00	573.30	582.30	63.70:1
CHANGE	0.00	0.00	0.00	

* 270 Volunteer Firefighter not included

2020 Preliminary Tax Supported Operating Budget

BY SECTION

	2019 Restated Gross	2019 Restated Net	2019 Projected Net	2020 Preliminary Gross	2020 Preliminary Net	'20 Preli. vs. '19 Rest. (\$)	'20 Preli. vs. '19 Rest. (%)
Emergency Management	372,580	372,580	372,990	383,040	383,040	10,460	2.8%
Fire Administration	1,986,650	1,986,650	2,461,690	2,032,890	2,032,890	46,240	2.3%
Fire Operations	90,152,490	89,724,740	89,268,840	91,823,800	91,273,780	1,549,040	1.7%
Total Hamilton Fire Department	92,511,720	92,083,970	92,103,520	94,239,730	93,689,710	1,605,740	1.7%

BY COST CATEGORY

	2019 Restated Budget	2019 Projected Actual	2020 Preliminary Budget	'20 Preli. vs. '19 Rest. (\$)	'20 Preli. vs. '19 Rest. (%)
EMPLOYEE RELATED COST	82,926,910	83,468,290	84,009,580	1,082,670	1.3%
MATERIAL AND SUPPLY	1,575,940	2,022,280	1,634,940	59,000	3.7%
VEHICLE EXPENSES	1,033,670	1,041,060	1,085,270	51,600	5.0%
BUILDING AND GROUND	1,144,170	972,690	1,115,350	(28,820)	(2.5%)
CONSULTING	15,000	15,000	15,000	0	0.0%
CONTRACTUAL	142,330	162,300	142,330	0	0.0%
RESERVES / RECOVERIES	5,326,440	5,601,690	5,801,020	474,580	8.9%
COST ALLOCATIONS	78,960	101,560	87,940	8,980	11.4%
FINANCIAL	268,300	239,370	348,300	80,000	29.8%
TOTAL EXPENDITURES	92,511,720	93,624,240	94,239,730	1,728,010	1.9%
FEES AND GENERAL	(427,750)	(462,340)	(550,020)	(122,270)	(28.6%)
RESERVES	0	(1,064,330)	0	0	0.0%
RECOVERIES FROM CAPITAL	0	5,960	0	0	0.0%
TOTAL REVENUES	(427,750)	(1,520,720)	(550,020)	(122,270)	(28.6%)
NET LEVY	92,083,970	92,103,520	93,689,710	1,605,740	1.7%

HAMILTON PARAMEDIC SERVICE

DIVISION STRUCTURE

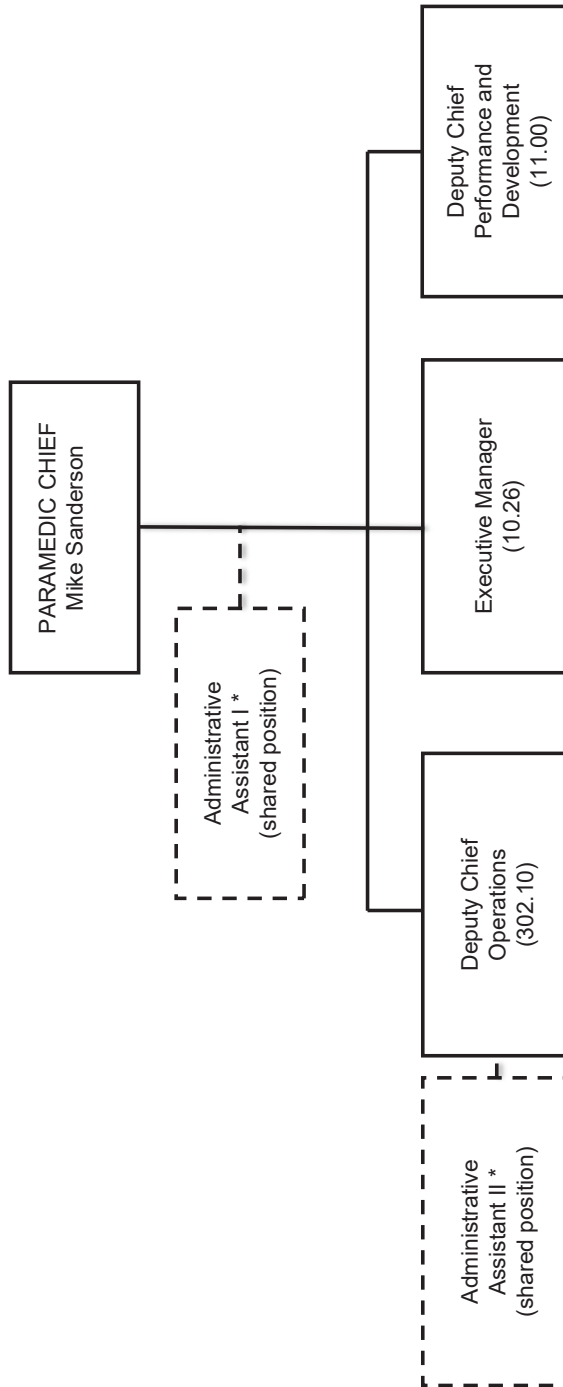

* Not included in complement

COMPLEMENT (FTE)	MANAGEMENT	OTHER	TOTAL	STAFF/MGT RATIO
2019	7.00	317.36	324.36	45.34:1
2020	7.00	317.36	324.36	45.34:1
CHANGE	0.00	0.00	0.00	

2020 Preliminary Tax Supported Operating Budget

BY SECTION

	2019 Restated Gross	2019 Restated Net	2019 Projected Net	2020 Preliminary Gross	2020 Preliminary Net	'20 Preli. vs. '19 Rest. (\$)	'20 Preli. vs. '19 Rest. (%)
Paramedic Service Admin	2,912,620	2,912,620	2,789,460	2,947,730	2,947,730	35,110	1.2%
Paramedic Service Operations	48,414,710	45,622,590	45,385,260	49,853,430	46,985,900	1,363,310	3.0%
Paramedic Service Provincial Funding	0	(24,740,440)	(23,673,900)	0	(24,824,860)	(84,420)	0.3%
Total Hamilton Paramedic Service	51,327,330	23,794,770	24,500,820	52,801,160	25,108,770	1,314,000	5.5%

BY COST CATEGORY

	2019 Restated Budget	2019 Projected Actual	2020 Preliminary Budget	'20 Preli. vs. '19 Rest. (\$)	'20 Preli. vs. '19 Rest. (%)
EMPLOYEE RELATED COST	42,366,600	41,823,300	43,488,840	1,122,240	2.6%
MATERIAL AND SUPPLY	1,908,610	1,981,640	1,923,090	14,480	0.8%
VEHICLE EXPENSES	903,990	868,710	927,500	23,510	2.6%
BUILDING AND GROUND	300,420	292,410	313,920	13,500	4.5%
CONSULTING	44,000	40,000	44,000	0	0.0%
CONTRACTUAL	1,526,470	1,532,380	1,528,180	1,710	0.1%
RESERVES / RECOVERIES	2,745,710	2,741,730	2,971,990	226,280	8.2%
COST ALLOCATIONS	1,446,530	1,424,620	1,518,640	72,110	5.0%
FINANCIAL	85,000	77,320	85,000	0	0.0%
TOTAL EXPENDITURES	51,327,330	50,782,110	52,801,160	1,473,830	2.9%
FEES AND GENERAL	(82,620)	(197,980)	(83,120)	(500)	(0.6%)
GRANTS AND SUBSIDIES	(27,449,940)	(26,083,300)	(27,609,270)	(159,330)	(0.6%)
TOTAL REVENUES	(27,532,560)	(26,281,280)	(27,692,390)	(159,830)	(0.6%)
NET LEVY	23,794,770	24,500,820	25,108,770	1,314,000	5.5%

PUBLIC HEALTH SERVICES

DIVISION STRUCTURE

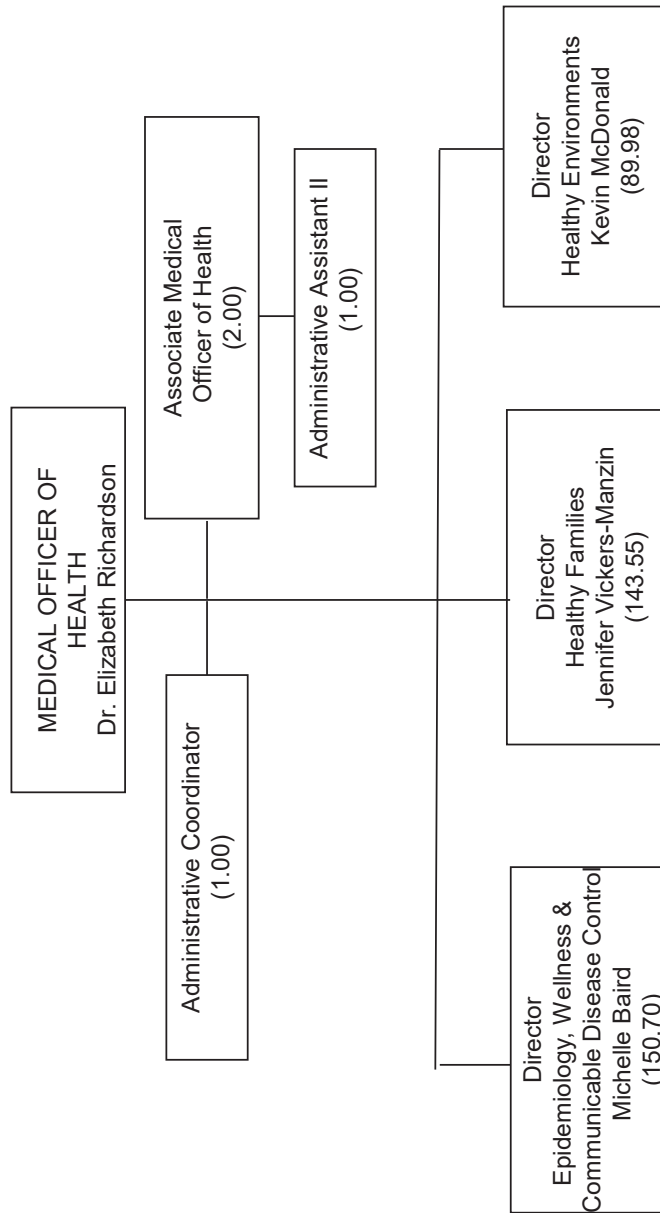

COMPLEMENT (FTE)	MANAGEMENT	OTHER	TOTAL	STAFF/MGT RATIO
2019	23.50	369.93	393.43	15.74:1
2020	23.50	372.23	395.73	15.94:1
CHANGE	0.00	2.30	2.30	

2020 Preliminary Tax Supported Operating Budget

BY SECTION

	2019 Restated Gross	2019 Restated Net	2019 Projected Net	2020 Preliminary Gross	2020 Preliminary Net	'20 Preli. vs. '19 Rest. (\$)	'20 Preli. vs. '19 Rest. (%)
Medical Officer of Health & Provincial Subsidy	2,501,350	(20,999,460)	(20,977,120)	2,577,690	(25,643,370)	(4,643,910)	22.1%
Epidemiology, Wellness and Communicable Disease Control	19,089,250	14,196,330	14,210,690	19,408,960	16,517,040	2,320,710	16.3%
Healthy Environments	12,256,340	9,257,430	9,478,560	12,266,590	11,646,420	2,388,990	25.8%
Healthy Families	17,675,640	9,902,200	9,834,490	19,461,110	10,952,900	1,050,700	10.6%
Total Public Health Services	51,522,580	12,356,500	12,546,620	53,714,350	13,472,990	1,116,490	9.0%

BY COST CATEGORY

	2019 Restated Budget	2019 Projected Actual	2020 Preliminary Budget	'20 Preli. vs. '19 Rest. (\$)	'20 Preli. vs. '19 Rest. (%)
EMPLOYEE RELATED COST	41,324,830	40,742,970	42,564,400	1,239,570	3.0%
MATERIAL AND SUPPLY	1,768,660	2,191,940	1,952,390	183,730	10.4%
VEHICLE EXPENSES	28,920	33,580	25,410	(3,510)	(12.1%)
BUILDING AND GROUND	2,072,040	2,094,260	2,107,990	35,950	1.7%
CONSULTING	8,240	33,250	33,240	25,000	303.4%
CONTRACTUAL	1,773,390	1,860,670	2,617,040	843,650	47.6%
AGENCIES and SUPPORT PAYMENTS	79,450	69,780	79,450	0	0.0%
RESERVES / RECOVERIES	317,840	349,620	329,140	11,300	3.6%
COST ALLOCATIONS	3,186,080	3,186,080	3,077,890	(108,190)	(3.4%)
FINANCIAL	429,350	398,380	393,620	(35,730)	(8.3%)
CAPITAL FINANCING	533,780	533,770	533,780	0	0.0%
TOTAL EXPENDITURES	51,522,580	51,494,300	53,714,350	2,191,770	4.3%
FEES AND GENERAL	(1,471,440)	(1,128,060)	(1,574,100)	(102,660)	(7.0%)
GRANTS AND SUBSIDIES	(37,694,640)	(32,790,000)	(38,667,260)	(972,620)	(2.6%)
TOTAL REVENUES	(39,166,080)	(33,918,060)	(40,241,360)	(1,075,280)	(2.7%)
NET LEVY	12,356,500	12,546,620	13,472,990	1,116,490	9.0%

PUBLIC WORKS



DEPARTMENT STRUCTURE

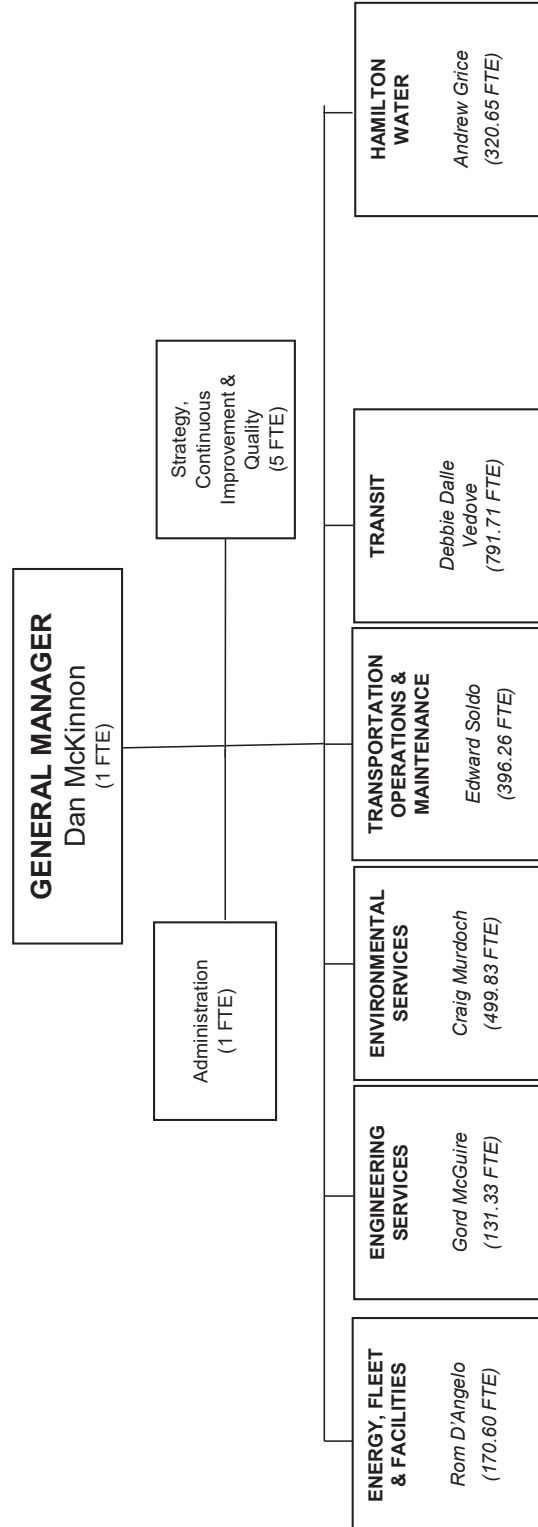

COMPLEMENT (FTE)	MANAGEMENT	OTHER	TOTAL	STAFF/MGT RATIO
2019	32.00	1,929.73	1,961.73	60.30:1
2020	32.00	1,964.73	1,996.73	61.40:1
CHANGE	0.00	35.00	35.00	

*Complement Excludes Hamilton Water

2020 Preliminary Tax Supported Operating Budget

BY DIVISION

	2019 Restated Gross	2019 Restated Net	2019 Projected Net	2020 Preliminary Gross	2020 Preliminary Net	'20 Prel. Net vs. '19 Rest. Net (\$)	'20 Prel. Net vs. '19 Rest. Net (%)
PW-General Administration	874,810	874,810	715,220	903,540	903,540	28,730	3.3%
Energy Fleet and Facilities	19,530,760	8,718,820	9,893,420	19,433,110	9,297,360	578,540	6.6%
Engineering Services	20,188,660	0	0	20,572,580	0	0	0.0%
Environmental Services	100,198,420	79,243,370	78,244,640	104,040,500	82,794,430	3,551,060	4.5%
Transit	130,791,570	74,298,880	76,213,180	141,439,580	81,395,710	7,096,830	9.6%
Transportation Operations & Maintenance	92,251,380	78,920,680	78,214,050	93,190,760	81,440,570	2,519,890	3.2%
Total Public Works - Tax	363,835,600	242,056,560	243,280,510	379,580,070	255,831,610	13,775,050	5.7%

BY COST CATEGORY

	2019 Restated Budget	2019 Projected Actual	2020 Preliminary Budget	'20 Preli. vs. '19 Rest. (\$)	'20 Preli. vs. '19 Rest. (%)
EMPLOYEE RELATED COST	182,146,430	181,613,710	188,109,240	5,962,810	3.3%
MATERIAL AND SUPPLY	23,911,970	23,811,750	25,766,920	1,854,950	7.8%
VEHICLE EXPENSES	33,198,470	32,703,820	34,052,820	854,350	2.6%
BUILDING AND GROUND	18,374,220	18,431,870	18,980,030	605,810	3.3%
CONSULTING	194,490	194,490	191,230	(3,260)	(1.7%)
CONTRACTUAL	90,666,910	91,724,700	94,571,470	3,904,560	4.3%
AGENCIES and SUPPORT PAYMENTS	179,480	196,150	179,480	0	0.0%
RESERVES / RECOVERIES	5,848,040	6,086,860	7,643,610	1,795,570	30.7%
COST ALLOCATIONS	2,898,880	2,974,520	2,349,920	(548,960)	(18.9%)
FINANCIAL	4,766,710	4,612,470	6,085,350	1,318,640	27.7%
CAPITAL FINANCING	1,650,000	1,650,000	1,650,000	0	0.0%
TOTAL EXPENDITURES	363,835,600	364,000,330	379,580,070	15,744,470	4.3%
FEES AND GENERAL	(72,815,230)	(73,399,930)	(77,192,240)	(4,377,010)	(6.0%)
GRANTS AND SUBSIDIES	(16,068,430)	(16,068,430)	(16,068,430)	0	0.0%
RESERVES	(6,993,930)	(6,918,930)	(3,956,530)	3,037,400	43.4%
RECOVERIES FROM CAPITAL	(25,901,450)	(24,332,540)	(26,531,260)	(629,810)	(2.4%)
TOTAL REVENUES	(121,779,040)	(120,719,830)	(123,748,460)	(1,969,420)	(1.6%)
NET LEVY	242,056,560	243,280,500	255,831,610	13,775,050	5.7%

2020 Preliminary Tax Supported Operating Budget Multi-Year Budget Outlook

BY DIVISION

	2021 Preliminary Gross	2021 Preliminary Net	2022 Preliminary Gross	2022 Preliminary Net	2023 Preliminary Gross	2023 Preliminary Net
PW-General Administration	921,990	921,990	940,800	940,800	960,000	960,000
Energy Fleet and Facilities	19,642,370	9,540,330	19,806,412	9,636,742	19,959,633	9,721,003
Engineering Services	20,925,290	0	21,261,660	0	21,593,020	0
Environmental Services	106,737,850	85,330,910	109,023,190	87,453,710	111,333,200	89,598,870
Transit	152,483,370	90,102,380	161,376,290	96,367,180	170,255,720	102,362,490
Transportation Operations & Maintenance	95,160,570	83,295,100	96,725,750	84,742,720	98,031,050	85,928,100
Total Public Works - Tax	395,871,440	269,190,710	409,134,102	279,141,152	422,132,623	288,570,463

2020 Preliminary Tax Supported Operating Budget

BY SECTION - GENERAL ADMINISTRATION

	2019 Restated Gross	2019 Restated Net	2019 Projected Net	2020 Preliminary Gross	2020 Preliminary Net	'20 Preli. vs. '19 Rest. (\$)	'20 Preli. vs. '19 Rest. (%)
PW General Managers Office	874,810	874,810	715,220	903,540	903,540	28,730	3.3%
Total PW-General Administration	874,810	874,810	715,220	903,540	903,540	28,730	3.3%

BY COST CATEGORY - GENERALADMINISTRATION

	2019 Restated Budget	2019 Projected Actual	2020 Preliminary Budget	'20 Preli. vs. '19 Rest. (\$)	'20 Preli. vs. '19 Rest. (%)
EMPLOYEE RELATED COST	1,072,950	1,063,900	1,095,780	22,830	2.1%
MATERIAL AND SUPPLY	43,130	52,180	43,130	0	0.0%
BUILDING AND GROUND	115,120	107,740	138,740	23,620	20.5%
CONSULTING	30,000	30,000	30,000	0	0.0%
CONTRACTUAL	73,190	73,190	73,190	0	0.0%
AGENCIES and SUPPORT PAYMENTS	150,000	0	150,000	0	0.0%
RESERVES / RECOVERIES	56,060	53,850	63,910	7,850	14.0%
COST ALLOCATIONS	(665,640)	(665,640)	(691,210)	(25,570)	(3.8%)
TOTAL EXPENDITURES	874,810	715,220	903,540	28,730	3.3%
TOTAL REVENUES	0	0	0	0	0.0%
NET LEVY	874,810	715,220	903,540	28,730	3.3%

ENERGY, FLEET AND FACILITIES

DIVISION STRUCTURE

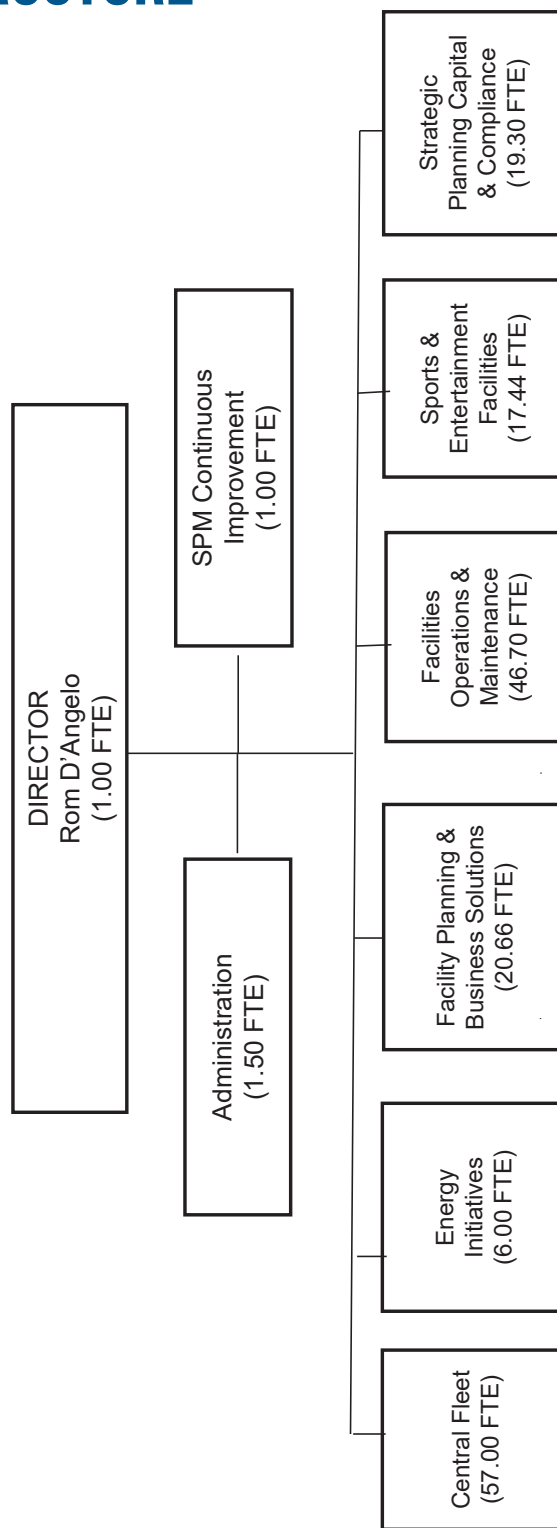

COMPLEMENT (FTE)	MANAGEMENT	OTHER	TOTAL	STAFF/MGT RATIO
2019	7.00	163.60	170.60	23.37:1
2020	7.00	163.60	170.60	23.37:1
CHANGE	0.00	0.00	0.00	

2020 Preliminary Tax Supported Operating Budget

BY SECTION

	2019 Restated Gross	2019 Restated Net	2019 Projected Net	2020 Preliminary Gross	2020 Preliminary Net	'20 Preli. vs. '19 Rest. (\$)	'20 Preli. vs. '19 Rest. (%)
Fleet Services	2,211,640	170,550	500,430	2,024,220	25,530	(145,020)	(85.0%)
Corporate Facility Ops & Tech	3,245,230	1,359,670	1,715,630	3,312,360	1,905,120	545,450	40.1%
Facilities Planning and Business Solutions	1,346,180	681,610	823,850	1,651,190	895,470	213,860	31.4%
Community Facility Ops & Tech Serv	3,164,410	3,164,410	3,256,650	3,258,090	3,258,090	93,680	3.0%
Sports & Entertainment Facilities	5,854,770	3,002,660	3,001,020	5,979,730	2,907,610	(95,050)	(3.2%)
Director EFF	326,120	305,310	560,310	327,550	305,750	440	0.1%
Energy Initiatives	1,347,840	36,120	37,040	818,550	0	(36,120)	(100.0%)
Strategic Plan & Capital Compliance	2,034,570	(1,510)	(1,510)	2,061,420	(210)	1,300	(86.1%)
Total Energy Fleet and Facilities	19,530,760	8,718,820	9,893,420	19,433,110	9,297,360	578,540	6.6%

BY COST CATEGORY

	2019 Restated Budget	2019 Projected Actual	2020 Preliminary Budget	'20 Preli. vs. '19 Rest. (\$)	'20 Preli. vs. '19 Rest. (%)
EMPLOYEE RELATED COST	17,937,970	18,298,780	18,661,440	723,470	4.0%
MATERIAL AND SUPPLY	1,603,450	1,598,080	1,551,940	(51,510)	(3.2%)
VEHICLE EXPENSES	6,891,210	6,891,210	6,907,620	16,410	0.2%
BUILDING AND GROUND	12,112,750	12,113,740	11,774,700	(338,050)	(2.8%)
CONSULTING	36,000	36,000	30,000	(6,000)	(16.7%)
CONTRACTUAL	6,001,950	5,993,860	7,338,050	1,336,100	22.3%
RESERVES / RECOVERIES	(26,658,280)	(26,369,720)	(28,372,330)	(1,714,050)	(6.4%)
COST ALLOCATIONS	258,110	258,110	201,850	(56,260)	(21.8%)
FINANCIAL	597,600	597,600	589,840	(7,760)	(1.3%)
CAPITAL FINANCING	750,000	750,000	750,000	0	0.0%
TOTAL EXPENDITURES	19,530,760	20,167,660	19,433,110	(97,650)	(0.5%)
FEEES AND GENERAL	(6,676,730)	(6,293,500)	(6,746,080)	(69,350)	(1.0%)
RESERVES	(2,005,730)	(1,855,730)	(1,059,090)	946,640	47.2%
RECOVERIES FROM CAPITAL	(2,129,480)	(2,125,010)	(2,330,580)	(201,100)	(9.4%)
TOTAL REVENUES	(10,811,940)	(10,274,240)	(10,135,750)	676,190	6.3%
NET LEVY	8,718,820	9,893,420	9,297,360	578,540	6.6%

ENGINEERING SERVICES

DIVISION STRUCTURE

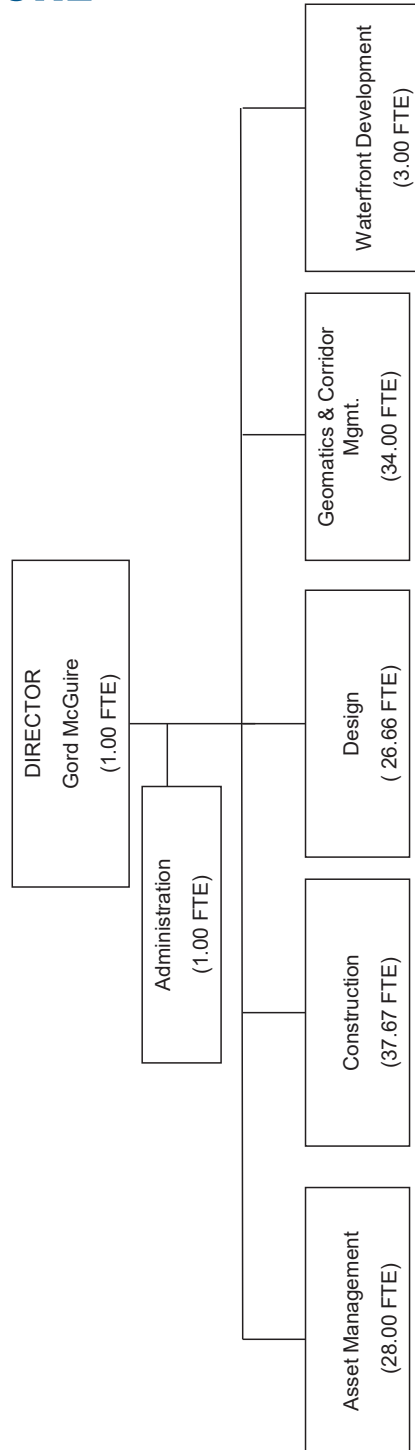

COMPLEMENT (FTE)	MANAGEMENT	OTHER	TOTAL	STAFF/MGT RATIO
2019	6.00	125.33	131.33	20.89:1
2020	6.00	125.33	131.33	20.89:1
CHANGE	0.00	0.00	0.00	

2020 Preliminary Tax Supported Operating Budget

BY SECTION

	2019 Restated Gross	2019 Restated Net	2019 Projected Net	2020 Preliminary Gross	2020 Preliminary Net	'20 Preli. vs. '19 Rest. (\$)	'20 Preli. vs. '19 Rest. (%)
Asset Management	3,306,260	0	0	3,474,180	0	0	0.0%
Construction	4,610,200	2,390	0	4,690,090	0	(2,390)	(100.0%)
Design Services	2,943,810	0	0	3,001,480	0	0	0.0%
Director of Engineering Services	1,675,710	(4,210)	0	1,681,310	0	4,210	(100.0%)
Geomatics and Corridor Management	6,874,500	1,130	0	6,992,680	0	(1,130)	(100.0%)
Waterfront Development	778,180	680	0	732,840	0	(680)	(100.0%)
Total Engineering Services	20,188,660	0	0	20,572,580	0	0	0.0%

BY COST CATEGORY

	2019 Restated Budget	2019 Projected Actual	2020 Preliminary Budget	'20 Preli. vs. '19 Rest. (\$)	'20 Preli. vs. '19 Rest. (%)
EMPLOYEE RELATED COST	14,056,070	13,516,910	14,461,470	405,400	2.9%
MATERIAL AND SUPPLY	180,280	171,260	183,960	3,680	2.0%
VEHICLE EXPENSES	91,450	90,700	98,120	6,670	7.3%
BUILDING AND GROUND	507,430	512,770	541,040	33,610	6.6%
CONTRACTUAL	2,289,570	2,285,580	2,290,560	990	0.0%
RESERVES / RECOVERIES	514,900	519,150	539,460	24,560	4.8%
COST ALLOCATIONS	1,558,060	1,551,010	1,467,070	(90,990)	(5.8%)
FINANCIAL	90,900	90,900	90,900	0	0.0%
CAPITAL FINANCING	900,000	900,000	900,000	0	0.0%
TOTAL EXPENDITURES	20,188,660	19,638,280	20,572,580	383,920	1.9%
FEEES AND GENERAL	(4,315,710)	(4,315,700)	(4,324,290)	(8,580)	(0.2%)
RECOVERIES FROM CAPITAL	(15,872,950)	(15,322,580)	(16,248,290)	(375,340)	(2.4%)
TOTAL REVENUES	(20,188,660)	(19,638,280)	(20,572,580)	(383,920)	(1.9%)
NET LEVY	0	0	0	0	0.0%

ENVIRONMENTAL SERVICES

DIVISION STRUCTURE

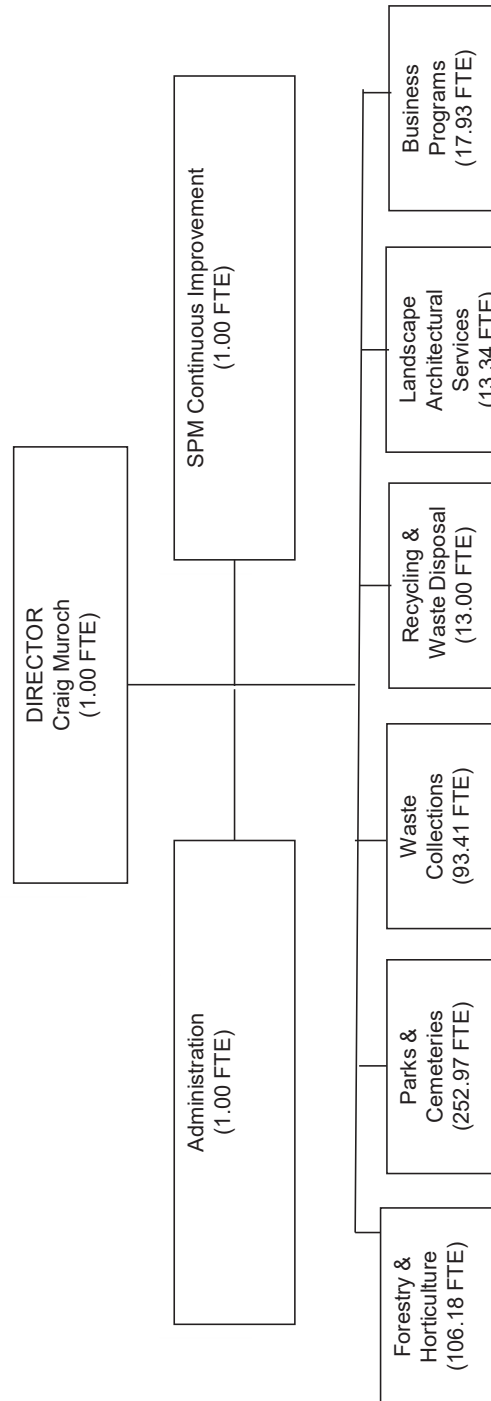

COMPLEMENT (FTE)	MANAGEMENT	OTHER	TOTAL	STAFF/MGT RATIO
2019	7.00	492.83	499.83	70.40:1
2020	7.00	492.83	499.83	70.40:1
CHANGE	0.00	0.00	0.00	

2020 Preliminary Tax Supported Operating Budget

BY SECTION

	2019 Restated Gross	2019 Restated Net	2019 Projected Net	2020 Preliminary Gross	2020 Preliminary Net	'20 Preli. vs. '19 Rest. (\$)	'20 Preli. vs. '19 Rest. (%)
Recycling & Waste Disposal	21,766,740	6,906,870	7,396,030	22,961,590	7,816,720	909,850	13.2%
Waste Collections	31,933,180	31,889,180	31,544,970	32,866,100	32,823,100	933,920	2.9%
Business Programs	2,189,260	2,076,090	2,038,000	2,281,510	2,166,850	90,760	4.4%
Director Environ Services	(701,070)	(701,070)	0	(701,070)	(701,070)	0	0.0%
Forestry & Horticulture	14,299,960	12,941,860	12,173,990	14,609,580	13,221,460	279,600	2.2%
Landscape & Architectural Serv	2,026,770	98,710	101,100	2,004,300	102,630	3,920	4.0%
Parks & Cemeteries	28,683,580	26,031,730	24,990,550	30,018,490	27,364,740	1,333,010	5.1%
Total Environmental Services	100,198,420	79,243,370	78,244,640	104,040,500	82,794,430	3,551,060	4.5%

BY COST CATEGORY

	2019 Restated Budget	2019 Projected Actual	2020 Preliminary Budget	'20 Preli. vs. '19 Rest. (\$)	'20 Preli. vs. '19 Rest. (%)
EMPLOYEE RELATED COST	40,570,810	39,023,000	41,338,160	767,350	1.9%
MATERIAL AND SUPPLY	2,807,230	2,807,230	2,901,200	93,970	3.3%
VEHICLE EXPENSES	5,051,860	5,051,860	5,313,720	261,860	5.2%
BUILDING AND GROUND	3,823,850	3,823,850	4,673,820	849,970	22.2%
CONSULTING	10,350	10,350	8,090	(2,260)	(21.8%)
CONTRACTUAL	40,936,130	41,506,130	42,738,420	1,802,290	4.4%
AGENCIES and SUPPORT PAYMENTS	29,480	29,480	29,480	0	0.0%
RESERVES / RECOVERIES	5,633,930	5,622,510	5,742,280	108,350	1.9%
COST ALLOCATIONS	423,950	423,950	384,500	(39,450)	(9.3%)
FINANCIAL	910,830	910,830	910,830	0	0.0%
TOTAL EXPENDITURES	100,198,420	99,209,190	104,040,500	3,842,080	3.8%
FEES AND GENERAL	(9,989,480)	(9,998,980)	(10,553,480)	(564,000)	(5.6%)
GRANTS AND SUBSIDIES	(5,169,430)	(5,169,430)	(5,169,430)	0	0.0%
RESERVES	(2,613,000)	(2,613,000)	(2,363,000)	250,000	9.6%
RECOVERIES FROM CAPITAL	(3,183,140)	(3,183,140)	(3,160,160)	22,980	0.7%
TOTAL REVENUES	(20,955,050)	(20,964,550)	(21,246,070)	(291,020)	(1.4%)
NET LEVY	79,243,370	78,244,640	82,794,430	3,551,060	4.5%

TRANSIT

DIVISION STRUCTURE

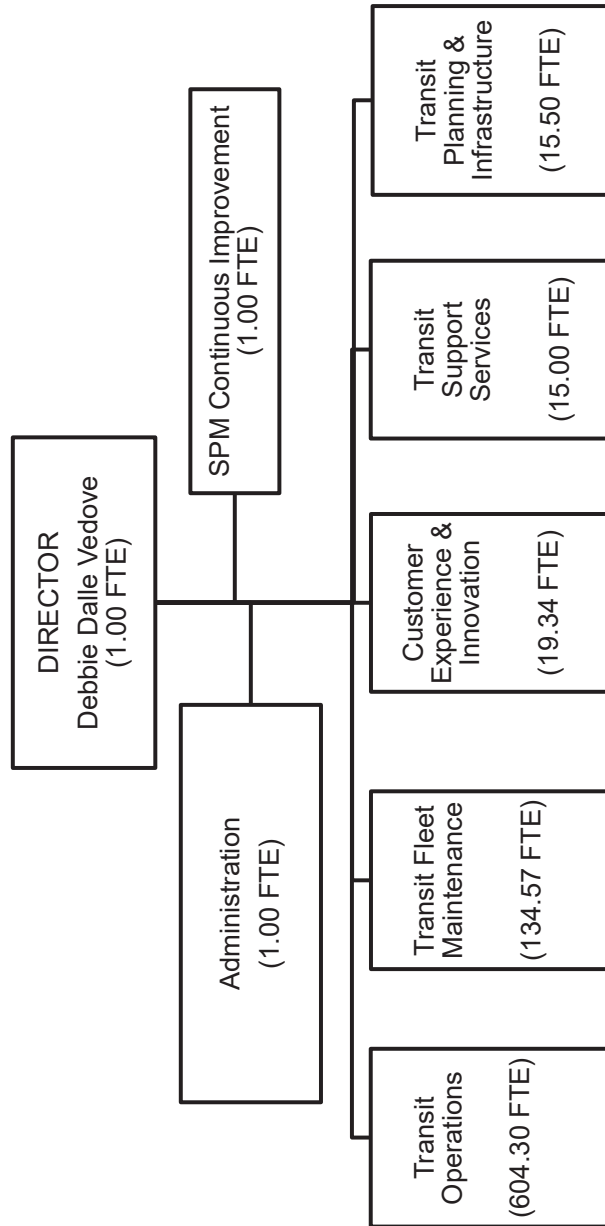

COMPLEMENT (FTE)	MANAGEMENT	OTHER	TOTAL	STAFF/MGT RATIO
2019	6.00	750.71	756.71	125.12:1
2020	6.00	785.71	791.71	130.95:1
CHANGE	0.00	35.00	35.00	

2020 Preliminary Tax Supported Operating Budget

BY SECTION

	2019 Restated Gross	2019 Restated Net	2019 Projected Net	2020 Preliminary Gross	2020 Preliminary Net	'20 Preli. vs. '19 Rest. (\$)	'20 Preli. vs. '19 Rest. (%)
Customer Experience and Innovation	4,891,860	3,541,660	3,520,250	5,537,410	4,187,210	645,550	18.2%
Transit Planning and Infrastructure	24,836,280	23,490,180	23,953,880	27,536,190	26,190,090	2,699,910	11.5%
Support Services	2,106,120	2,105,120	1,863,660	2,130,050	2,129,050	23,930	1.1%
Director of Transit	124,890	124,890	560,660	134,200	134,200	9,310	7.5%
Financial Charges & General Revenue	13,087,920	(33,597,270)	(34,841,620)	15,708,680	(34,527,690)	(930,420)	2.8%
Operations HSR	53,880,880	46,980,520	50,482,370	57,671,540	50,771,180	3,790,660	8.1%
Transit Fleet	31,863,620	31,653,780	30,673,980	32,721,510	32,511,670	857,890	2.7%
Total Transit	130,791,570	74,298,880	76,213,180	141,439,580	81,395,710	7,096,830	9.6%

BY COST CATEGORY

	2019 Restated Budget	2019 Projected Actual	2020 Preliminary Budget	'20 Preli. vs. '19 Rest. (\$)	'20 Preli. vs. '19 Rest. (%)
EMPLOYEE RELATED COST	71,433,380	74,483,830	75,297,340	3,863,960	5.4%
MATERIAL AND SUPPLY	2,202,700	2,107,820	2,381,700	179,000	8.1%
VEHICLE EXPENSES	13,945,060	13,451,160	13,999,110	54,050	0.4%
BUILDING AND GROUND	792,120	850,820	933,740	141,620	17.9%
CONSULTING	51,880	51,880	51,880	0	0.0%
CONTRACTUAL	24,804,290	25,304,150	27,763,420	2,959,130	11.9%
RESERVES / RECOVERIES	14,461,710	14,438,190	16,519,530	2,057,820	14.2%
COST ALLOCATIONS	74,110	156,810	136,540	62,430	84.2%
FINANCIAL	3,026,320	2,872,080	4,356,320	1,330,000	43.9%
TOTAL EXPENDITURES	130,791,570	133,716,730	141,439,580	10,648,010	8.1%
FEEES AND GENERAL	(45,593,690)	(46,552,120)	(49,144,870)	(3,551,180)	(7.8%)
GRANTS AND SUBSIDIES	(10,899,000)	(10,899,000)	(10,899,000)	0	0.0%
RECOVERIES FROM CAPITAL	0	(52,430)	0	0	0.0%
TOTAL REVENUES	(56,492,690)	(57,503,550)	(60,043,870)	(3,551,180)	(6.3%)
NET LEVY	74,298,880	76,213,180	81,395,710	7,096,830	9.6%

TRANSPORTATION,
OPERATIONS AND
MAINTENANCE

DIVISION STRUCTURE

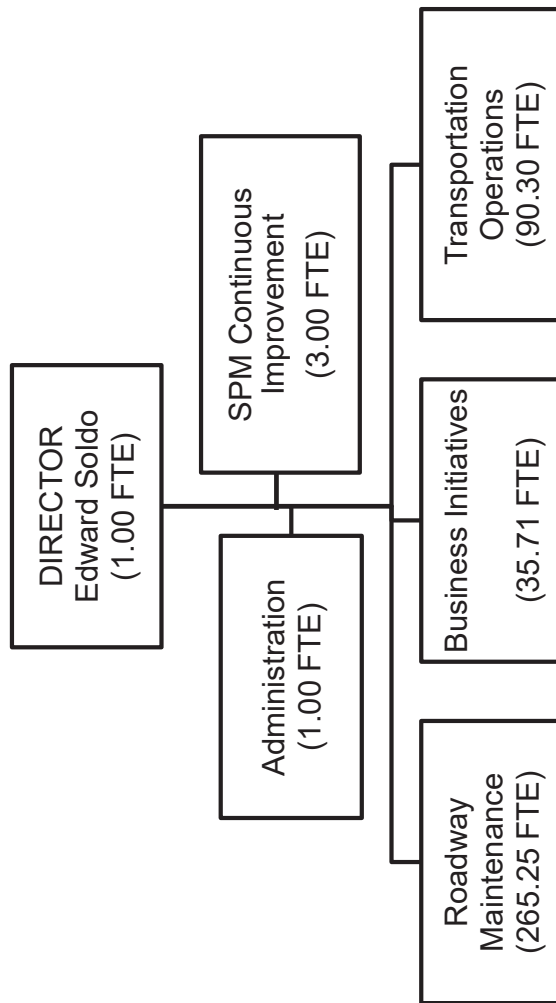

COMPLEMENT (FTE)	MANAGEMENT	OTHER	TOTAL	STAFF/MGT RATIO
2019	4.00	392.26	396.26	98.07:1
2020	4.00	392.26	396.26	98.07:1
CHANGE	0.00	0.00	0.00	

2020 Preliminary Tax Supported Operating Budget

BY SECTION

	2019 Restated Gross	2019 Restated Net	2019 Projected Net	2020 Preliminary Gross	2020 Preliminary Net	'20 Preli. vs. '19 Rest. (\$)	'20 Preli. vs. '19 Rest. (%)
Roadway Maintenance	63,532,700	62,229,330	60,721,890	65,724,580	63,936,340	1,707,010	2.7%
Director – Trans Ops & Mtce	(629,950)	(629,950)	0	(629,950)	(629,950)	0	0.0%
Transportation Operations	25,581,710	13,753,490	13,937,100	24,235,020	14,372,510	619,020	4.5%
Business Initiatives	3,766,920	3,567,810	3,555,060	3,861,110	3,761,670	193,860	5.4%
Total Transportation Operations & Maintenance	92,251,380	78,920,680	78,214,050	93,190,760	81,440,570	2,519,890	3.2%

BY COST CATEGORY

	2019 Restated Budget	2019 Projected Actual	2020 Preliminary Budget	'20 Preli. vs. '19 Rest. (\$)	'20 Preli. vs. '19 Rest. (%)
EMPLOYEE RELATED COST	37,075,250	35,227,290	37,255,050	179,800	0.5%
MATERIAL AND SUPPLY	17,075,180	17,075,180	18,704,990	1,629,810	9.5%
VEHICLE EXPENSES	7,218,890	7,218,890	7,734,250	515,360	7.1%
BUILDING AND GROUND	1,022,950	1,022,950	917,990	(104,960)	(10.3%)
CONSULTING	66,260	66,260	71,260	5,000	7.5%
CONTRACTUAL	16,561,780	16,561,780	14,367,830	(2,193,950)	(13.2%)
AGENCIES and SUPPORT PAYMENTS	0	166,670	0	0	0.0%
RESERVES / RECOVERIES	11,839,720	11,822,880	13,150,760	1,311,040	11.1%
COST ALLOCATIONS	1,250,290	1,250,290	851,170	(399,120)	(31.9%)
FINANCIAL	141,060	141,060	137,460	(3,600)	(2.6%)
TOTAL EXPENDITURES	92,251,380	90,553,250	93,190,760	939,380	1.0%
FEES AND GENERAL	(6,239,620)	(6,239,620)	(6,423,520)	(183,900)	(2.9%)
RESERVES	(2,375,200)	(2,450,200)	(534,440)	1,840,760	77.5%
RECOVERIES FROM CAPITAL	(4,715,880)	(3,649,380)	(4,792,230)	(76,350)	(1.6%)
TOTAL REVENUES	(13,330,700)	(12,339,200)	(11,750,190)	1,580,510	11.9%
NET LEVY	78,920,680	78,214,050	81,440,570	2,519,890	3.2%

CITY MANAGER'S OFFICE



DEPARTMENT STRUCTURE

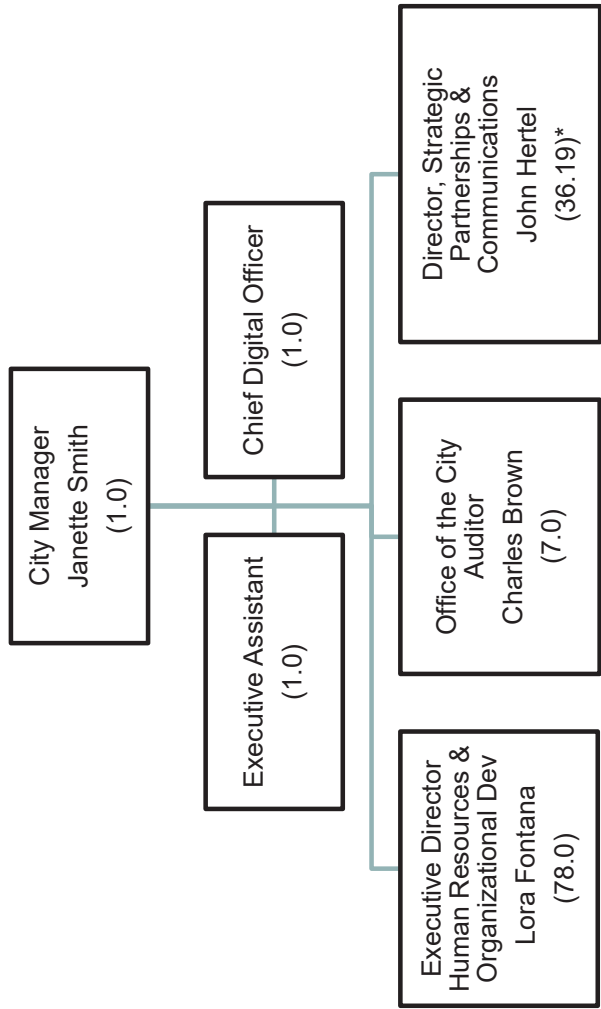

COMPLEMENT (FTE)	MANAGEMENT	OTHER	TOTAL	STAFF/MGT RATIO
2019	16.00	108.19	124.19	6.7:1
2020	17.00	107.19	124.19	6.7:1
CHANGE	1.00	(1.00)	0.00	

* Denotes positions included in the complement, funded by the operating departments and appear in their budget
 • Strategic Partnerships & Revenue Generation – 4.19 for Hamilton Farmer’s Market

2020 Preliminary Tax Supported Operating Budget

BY DIVISION

	2019 Restated Gross	2019 Restated Net	2019 Projected Net	2020 Preliminary Gross	2020 Preliminary Net	'20 Prel. Net vs. '19 Rest. Net (\$)	'20 Prel. Net vs. '19 Rest. Net (%)
Office of the City Auditor	1,159,980	1,129,980	1,082,310	1,181,710	1,151,710	21,730	1.9%
CMO - Admin & Digital Office	421,750	391,750	474,190	451,010	421,010	29,260	7.5%
Strategic Partnerships & Communications	4,370,360	3,025,040	2,711,310	4,467,820	3,137,840	112,800	3.7%
Human Resources	9,450,540	7,396,650	7,216,880	9,638,340	7,552,560	155,910	2.1%
Total City Manager	15,402,630	11,943,420	11,484,690	15,738,880	12,263,120	319,700	2.7%

BY COST CATEGORY

	2019 Restated Budget	2019 Projected Actual	2020 Preliminary Budget	'20 Preli. vs. '19 Rest. (\$)	'20 Preli. vs. '19 Rest. (%)
EMPLOYEE RELATED COST	14,816,010	14,185,620	15,306,020	490,010	3.3%
MATERIAL AND SUPPLY	675,290	727,590	693,090	17,800	2.6%
BUILDING AND GROUND	486,930	486,630	466,210	(20,720)	(4.3%)
CONSULTING	342,790	513,070	330,790	(12,000)	(3.5%)
CONTRACTUAL	1,274,110	1,028,620	1,303,520	29,410	2.3%
AGENCIES and SUPPORT PAYMENTS	50,000	50,000	50,000	0	0.0%
RESERVES / RECOVERIES	343,730	352,590	342,420	(1,310)	(0.4%)
COST ALLOCATIONS	(3,325,080)	(3,325,080)	(3,492,020)	(166,940)	(5.0%)
FINANCIAL	682,640	680,840	682,640	0	0.0%
CAPITAL FINANCING	56,210	56,210	56,210	0	0.0%
TOTAL EXPENDITURES	15,402,630	14,756,090	15,738,880	336,250	2.2%
FEES AND GENERAL	(1,349,820)	(1,162,020)	(1,334,480)	15,340	1.1%
RESERVES	(2,079,390)	(2,079,390)	(2,111,280)	(31,890)	(1.5%)
RECOVERIES FROM CAPITAL	(30,000)	(30,000)	(30,000)	0	0.0%
TOTAL REVENUES	(3,459,210)	(3,271,410)	(3,475,760)	(16,550)	(0.5%)
NET LEVY	11,943,420	11,484,690	12,263,120	319,700	2.7%

2020 Preliminary Tax Supported Operating Budget Multi-Year Budget Outlook

BY DIVISION

	2021 Preliminary Gross	2021 Preliminary Net	2022 Preliminary Gross	2022 Preliminary Net	2023 Preliminary Gross	2023 Preliminary Net
Office of the City Auditor	1,208,030	1,178,030	1,229,980	1,199,980	1,251,380	1,221,380
CMO - Admin & Digital Office	468,720	438,720	480,020	450,020	490,950	460,950
Strategic Partnerships & Communications	4,568,200	3,211,620	4,648,800	3,265,090	4,727,480	3,316,100
Human Resources	9,819,510	7,695,450	9,991,850	7,828,750	10,158,920	7,956,000
Total City Manager	16,064,460	12,523,820	16,350,650	12,743,840	16,628,730	12,954,430

2020 Preliminary Tax Supported Operating Budget

BY SECTION - ADMIN AND DIGITAL OFFICE

	2019 Restated Gross	2019 Restated Net	2019 Projected Net	2020 Preliminary Gross	2020 Preliminary Net	'20 Preli. vs. '19 Rest. (\$)	'20 Preli. vs. '19 Rest. (%)
CMO - Administration	421,750	391,750	474,190	451,010	421,010	29,260	7.5%
Total CMO - Admin & Digital Office	421,750	391,750	474,190	451,010	421,010	29,260	7.5%

BY COST CATEGORY - ADMIN AND DIGITAL OFFICE

	2019 Restated Budget	2019 Projected Actual	2020 Preliminary Budget	'20 Preli. vs. '19 Rest. (\$)	'20 Preli. vs. '19 Rest. (%)
EMPLOYEE RELATED COST	644,170	598,650	672,810	28,640	4.4%
MATERIAL AND SUPPLY	22,350	22,350	22,650	300	1.3%
BUILDING AND GROUND	900	900	880	0	(2.2%)
CONSULTING	0	120,280	0	0	0.0%
CONTRACTUAL	1,660	1,660	2,470	810	48.8%
RESERVES / RECOVERIES	53,760	61,430	59,490	5,730	10.7%
COST ALLOCATIONS	(301,090)	(301,090)	(307,290)	(6,200)	(2.1%)
TOTAL EXPENDITURES	421,750	504,190	451,010	29,280	6.9%
RECOVERIES FROM CAPITAL	(30,000)	(30,000)	(30,000)	0	0.0%
TOTAL REVENUES	(30,000)	(30,000)	(30,000)	0	0.0%
NET LEVY	391,750	474,190	421,010	29,280	7.5%

OFFICE OF THE
CITY AUDITOR

DIVISION STRUCTURE

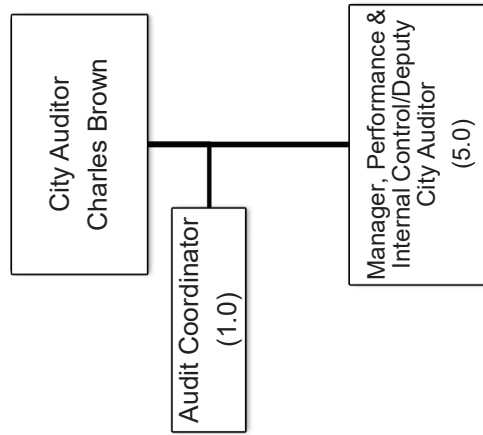

COMPLEMENT (FTE)	MANAGEMENT	OTHER	TOTAL	STAFF/MGT RATIO
2019	1.00	6.00	7.00	6:1
2020	2.00	5.00	7.00	2.5:1
CHANGE	1.00	(1.00)	0.00	

2020 Preliminary Tax Supported Operating Budget

BY SECTION

	2019 Restated Gross	2019 Restated Net	2019 Projected Net	2020 Preliminary Gross	2020 Preliminary Net	'20 Preli. vs. '19 Rest. (\$)	'20 Preli. vs. '19 Rest. (%)
Audit Services	1,159,980	1,129,980	1,082,310	1,181,710	1,151,710	21,730	1.9%
Total Office of the City Auditor	1,159,980	1,129,980	1,082,310	1,181,710	1,151,710	21,730	1.9%

BY COST CATEGORY

	2019 Restated Budget	2019 Projected Actual	2020 Preliminary Budget	'20 Preli. vs. '19 Rest. (\$)	'20 Preli. vs. '19 Rest. (%)
EMPLOYEE RELATED COST	988,110	954,440	1,027,140	39,030	3.9%
MATERIAL AND SUPPLY	4,430	4,430	4,430	0	0.0%
BUILDING AND GROUND	1,650	1,650	1,600	0	(3.0%)
CONSULTING	30,000	30,000	30,000	0	0.0%
CONTRACTUAL	1,000	1,000	1,000	0	0.0%
RESERVES / RECOVERIES	78,040	64,040	60,790	(17,250)	(22.1%)
FINANCIAL	540	540	540	0	0.0%
CAPITAL FINANCING	56,210	56,210	56,210	0	0.0%
TOTAL EXPENDITURES	1,159,980	1,112,310	1,181,710	21,780	1.9%
RESERVES	(30,000)	(30,000)	(30,000)	0	0.0%
TOTAL REVENUES	(30,000)	(30,000)	(30,000)	0	0.0%
NET LEVY	1,129,980	1,082,310	1,151,710	21,780	1.9%

STRATEGIC PARTNERSHIPS & COMMUNICATIONS

DIVISION STRUCTURE

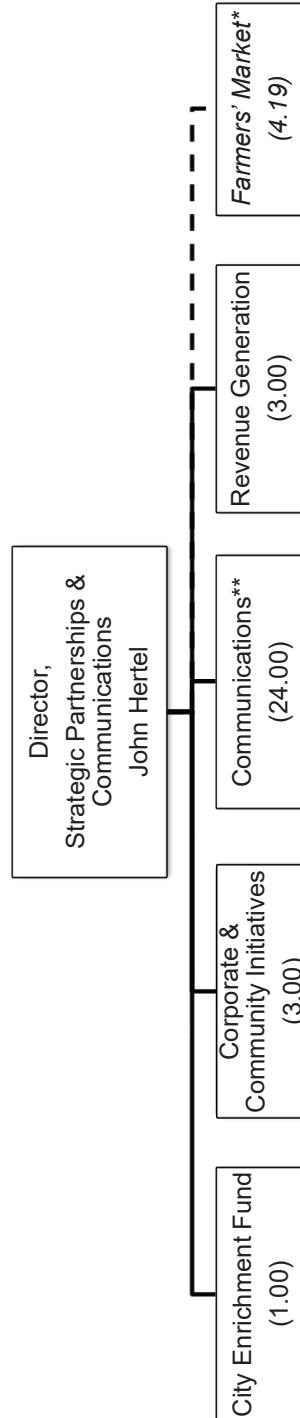

COMPLEMENT (FTE)	MANAGEMENT	* DISTRIBUTED MANAGEMENT	OTHER	* DISTRIBUTED OTHER	TOTAL	STAFF/MGT RATIO
2019	4.00	1.00	28.00	3.19	36.19	6.2:1
2020	4.00	1.00	28.00	3.19	36.19	6.2:1
CHANGE	0.00	0.00	0.00	0.00	0.00	

*Distributed staff represent a direct reporting structure to John Hertel of Hamilton Market employees. Hamilton Market budget resides in Boards and Agencies

**Communications include: Communication Officers, Digital Communications (Web), Social Media & Marketing, and Graphic Design

2020 Preliminary Tax Supported Operating Budget

BY SECTION

	2019 Restated Gross	2019 Restated Net	2019 Projected Net	2020 Preliminary Gross	2020 Preliminary Net	'20 Preli. vs. '19 Rest. (\$)	'20 Preli. vs. '19 Rest. (%)
Communications	1,848,100	1,848,100	1,667,110	1,921,010	1,921,010	72,910	3.9%
Social Media	459,260	429,260	298,310	473,980	443,980	14,720	3.4%
Corporate & Community Initiatives	577,070	577,070	575,120	588,130	588,130	11,060	1.9%
Revenue Generation	915,320	(400,000)	(400,000)	899,980	(400,000)	0	0.0%
Administration	570,610	570,610	570,770	584,720	584,720	14,110	2.5%
Total Strategic Partnerships & Communications	4,370,360	3,025,040	2,711,310	4,467,820	3,137,840	112,800	3.7%

BY COST CATEGORY

	2019 Restated Budget	2019 Projected Actual	2020 Preliminary Budget	'20 Preli. vs. '19 Rest. (\$)	'20 Preli. vs. '19 Rest. (%)
EMPLOYEE RELATED COST	3,557,840	3,243,560	3,690,650	132,810	3.7%
MATERIAL AND SUPPLY	130,840	183,140	148,340	17,500	13.4%
BUILDING AND GROUND	5,220	4,920	8,190	2,970	56.9%
CONSULTING	61,680	61,680	49,680	(12,000)	(19.5%)
CONTRACTUAL	760,060	514,570	757,040	(3,020)	(0.4%)
AGENCIES and SUPPORT PAYMENTS	50,000	50,000	50,000	0	0.0%
RESERVES / RECOVERIES	99,420	107,460	108,600	9,180	9.2%
COST ALLOCATIONS	(327,150)	(327,150)	(377,130)	(49,980)	(15.3%)
FINANCIAL	32,450	30,650	32,450	0	0.0%
TOTAL EXPENDITURES	4,370,360	3,868,830	4,467,820	97,460	2.2%
FEES AND GENERAL	(1,345,320)	(1,157,520)	(1,329,980)	15,340	1.1%
TOTAL REVENUES	(1,345,320)	(1,157,520)	(1,329,980)	15,340	1.1%
NET LEVY	3,025,040	2,711,310	3,137,840	112,800	3.7%

HUMAN RESOURCES

DIVISION STRUCTURE

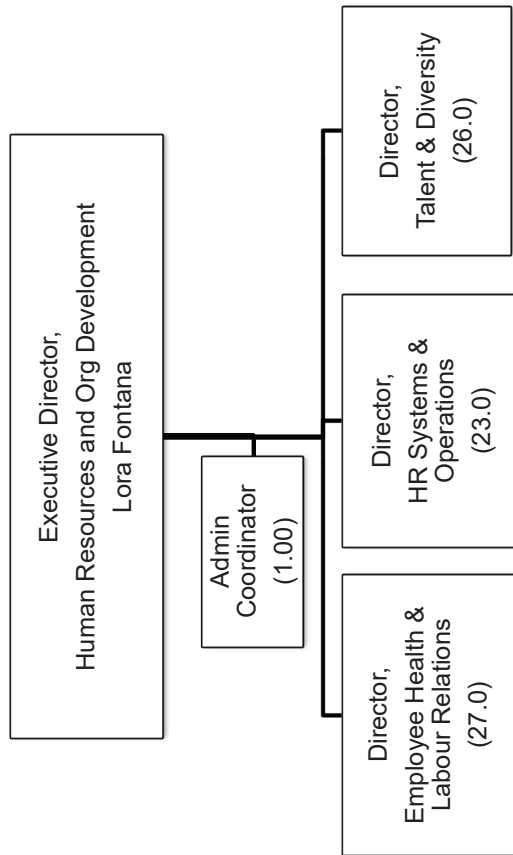

COMPLEMENT (FTE)	MANAGEMENT	OTHER	TOTAL	STAFF/MGT RATIO
2019	8.00	70.00	78.00	8.7:1
2020	8.00	70.00	78.00	8.7:1
CHANGE	0.00	0.00	0.00	

2020 Preliminary Tax Supported Operating Budget

BY SECTION

	2019 Restated Gross	2019 Restated Net	2019 Projected Net	2020 Preliminary Gross	2020 Preliminary Net	'20 Preli. vs. '19 Rest. (\$)	'20 Preli. vs. '19 Rest. (%)
Emp Health & Labour Relations	4,153,390	2,870,330	2,813,120	4,160,960	2,856,810	(13,520)	(0.5%)
HR Systems & Operations	2,540,580	1,933,480	1,756,920	2,612,360	1,994,690	61,210	3.2%
Human Resources Admin	220,430	200,200	339,740	191,590	171,130	(29,070)	(14.5%)
Talent and Diversity	2,536,140	2,392,640	2,307,090	2,673,430	2,529,930	137,290	5.7%
Total Human Resources	9,450,540	7,396,650	7,216,880	9,638,340	7,552,560	155,910	2.1%

BY COST CATEGORY

	2019 Restated Budget	2019 Projected Actual	2020 Preliminary Budget	'20 Preli. vs. '19 Rest. (\$)	'20 Preli. vs. '19 Rest. (%)
EMPLOYEE RELATED COST	9,625,890	9,388,970	9,915,420	289,530	3.0%
MATERIAL AND SUPPLY	517,670	517,670	517,670	0	0.0%
BUILDING AND GROUND	479,160	479,160	455,540	(23,620)	(4.9%)
CONSULTING	251,110	301,110	251,110	0	0.0%
CONTRACTUAL	511,390	511,390	543,010	31,620	6.2%
RESERVES / RECOVERIES	112,510	119,660	113,540	1,030	0.9%
COST ALLOCATIONS	(2,696,840)	(2,696,840)	(2,807,600)	(110,760)	(4.1%)
FINANCIAL	649,650	649,650	649,650	0	0.0%
TOTAL EXPENDITURES	9,450,540	9,270,770	9,638,340	187,800	2.0%
FEES AND GENERAL	(4,500)	(4,500)	(4,500)	0	0.0%
RESERVES	(2,049,390)	(2,049,390)	(2,081,280)	(31,890)	(1.6%)
TOTAL REVENUES	(2,053,890)	(2,053,890)	(2,085,780)	(31,890)	(1.6%)
NET LEVY	7,396,650	7,216,880	7,552,560	155,910	2.1%

CORPORATE SERVICES



DIVISION STRUCTURE

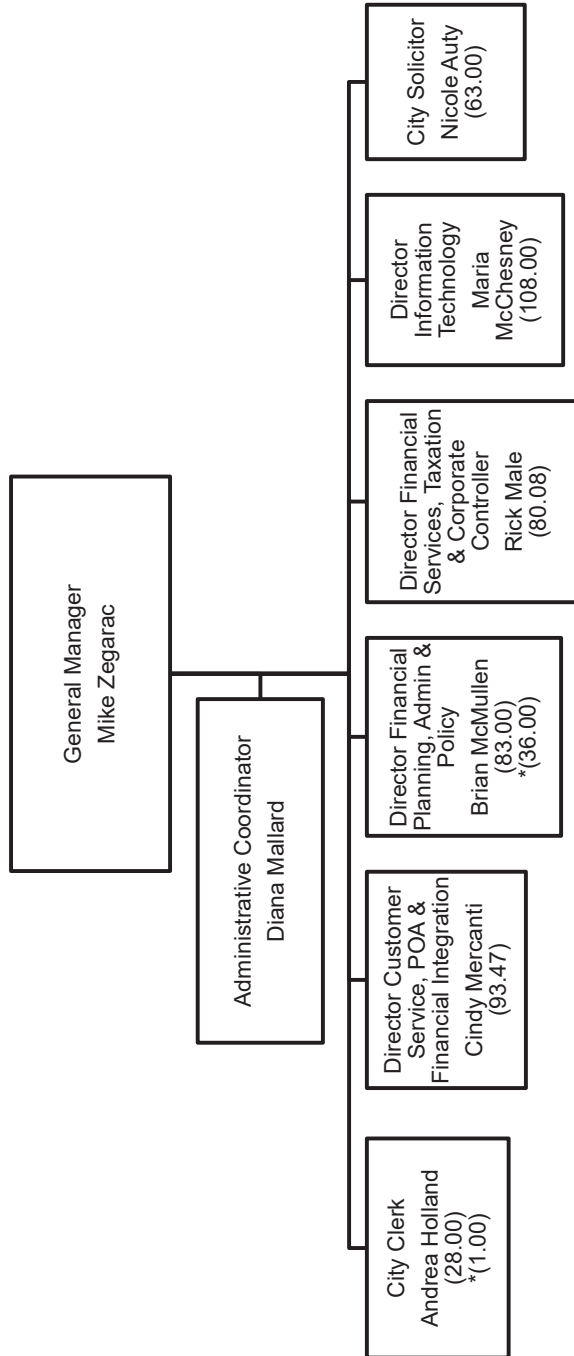

COMPLEMENT (FTE)	MANAGEMENT	* DISTRIBUTED MANAGEMENT	OTHER	* DISTRIBUTED OTHER	TOTAL	STAFF/MGT RATIO
2019	31.00	1.00	426.55	36.00	494.55	14.45:1
2020	31.00	1.00	426.55	36.00	494.55	14.45:1
CHANGE	0.00	0.00	0.00	0.00	0.00	

* * Represents distributed staff whose budget are in operating departments.

2020 Preliminary Tax Supported Operating Budget

BY DIVISION

	2019 Restated Gross	2019 Restated Net	2019 Projected Net	2020 Preliminary Gross	2020 Preliminary Net	'20 Prel. Net vs. '19 Rest. Net (\$)	'20 Prel. Net vs. '19 Rest. Net (%)
Corporate Services - Administration	315,420	315,420	317,840	324,850	324,850	9,430	3.0%
City Clerk's Office	3,202,650	2,619,110	2,239,990	3,374,160	2,790,620	171,510	6.5%
Customer Service	10,444,700	5,555,340	5,290,280	11,875,160	5,524,970	(30,370)	(0.5%)
Financial Planning, Admin & Policy	7,223,200	4,817,260	4,755,050	7,322,250	4,914,490	97,230	2.0%
Financial Services	6,757,840	3,975,310	3,659,320	7,088,390	4,246,800	271,490	6.8%
Information Technology	16,069,380	11,494,450	10,820,350	16,076,640	11,503,390	8,940	0.1%
Legal Services	4,394,110	3,505,470	3,382,750	4,404,990	3,416,350	(89,120)	(2.5%)
Total Corporate Services	48,407,300	32,282,360	30,465,580	50,466,440	32,721,470	439,110	1.4%

BY COST CATEGORY

	2019 Restated Budget	2019 Projected Actual	2020 Preliminary Budget	'20 Prel. vs. '19 Rest. (\$)	'20 Prel. vs. '19 Rest. (%)
EMPLOYEE RELATED COST	45,081,110	43,606,220	46,044,480	963,370	2.1%
MATERIAL AND SUPPLY	7,526,200	7,368,580	9,331,810	1,805,610	24.0%
VEHICLE EXPENSES	18,040	17,490	15,820	(2,220)	(12.3%)
BUILDING AND GROUND	959,610	943,420	452,960	(506,650)	(52.8%)
CONSULTING	65,760	62,940	65,760	0	0.0%
CONTRACTUAL	4,314,800	4,381,970	4,354,040	39,240	0.9%
RESERVES / RECOVERIES	470,310	120,730	(1,407,380)	(1,877,690)	(399.2%)
COST ALLOCATIONS	(12,147,660)	(12,051,550)	(12,417,380)	(269,720)	(2.2%)
FINANCIAL	2,037,510	1,866,840	2,066,710	29,200	1.4%
CAPITAL FINANCING	81,620	81,620	1,959,620	1,878,000	2,300.9%
TOTAL EXPENDITURES	48,407,300	46,398,260	50,466,440	2,059,140	4.3%
FEES AND GENERAL	(8,927,600)	(8,722,170)	(10,496,980)	(1,569,380)	(17.6%)
TAX AND RATES	(380,000)	(500,000)	(400,000)	(20,000)	(5.3%)
RESERVES	(4,814,470)	(4,727,470)	(4,814,470)	0	0.0%
RECOVERIES FROM CAPITAL	(2,002,870)	(1,983,040)	(2,033,520)	(30,650)	(1.5%)
TOTAL REVENUES	(16,124,940)	(15,932,680)	(17,744,970)	(1,620,030)	(10.0%)
NET LEVY	32,282,360	30,465,580	32,721,470	439,110	1.4%

2020 Preliminary Tax Supported Operating Budget Multi-Year Budget Outlook

BY DIVISION

	2021 Preliminary Gross	2021 Preliminary Net	2022 Preliminary Gross	2022 Preliminary Net	2023 Preliminary Gross	2023 Preliminary Net
Corporate Services - Administration	331,240	331,240	337,470	337,470	343,510	343,510
City Clerk's Office	3,455,770	2,861,520	3,520,370	2,915,200	3,584,180	2,967,860
Customer Service	12,059,240	5,646,840	12,230,430	5,757,580	12,399,360	5,866,420
Financial Planning, Admin & Policy	7,540,980	5,096,460	7,718,480	5,250,400	7,892,510	5,399,050
Financial Services	7,230,530	4,346,620	7,381,410	4,458,050	7,529,330	4,566,140
Information Technology	17,301,420	12,727,350	17,966,340	13,391,440	18,624,860	14,049,100
Legal Services	4,565,290	3,576,650	4,692,270	3,703,630	4,814,840	3,826,200
Total Corporate Services	52,484,470	34,586,680	53,846,770	35,813,770	55,188,590	37,018,280

2020 Preliminary Tax Supported Operating Budget

BY SECTION - ADMINISTRATION

	2019 Restated Gross	2019 Restated Net	2019 Projected Net	2020 Preliminary Gross	2020 Preliminary Net	'20 Preli. vs. '19 Rest. (\$)	'20 Preli. vs. '19 Rest. (%)
General Manager Office	315,420	315,420	317,840	324,850	324,850	9,430	3.0%
Total Corporate Services - Administration	315,420	315,420	317,840	324,850	324,850	9,430	3.0%

BY COST CATEGORY - ADMINISTRATION

	2019 Restated Budget	2019 Projected Actual	2020 Preliminary Budget	'20 Preli. vs. '19 Rest. (\$)	'20 Preli. vs. '19 Rest. (%)
EMPLOYEE RELATED COST	389,650	378,200	397,990	8,340	2.1%
MATERIAL AND SUPPLY	3,930	3,930	3,930	0	0.0%
BUILDING AND GROUND	300	300	300	0	0.0%
CONSULTING	25,000	25,000	25,000	0	0.0%
CONTRACTUAL	6,900	6,900	6,900	0	0.0%
RESERVES / RECOVERIES	9,850	23,720	10,950	1,100	11.2%
COST ALLOCATIONS	(126,710)	(126,710)	(126,710)	0	0.0%
FINANCIAL	6,500	6,500	6,500	0	0.0%
TOTAL EXPENDITURES	315,420	317,840	324,850	9,430	3.0%
TOTAL REVENUES	0	0	0	0	0.0%
NET LEVY	315,420	317,840	324,850	9,430	3.0%

CITY CLERK'S OFFICE

DIVISION STRUCTURE

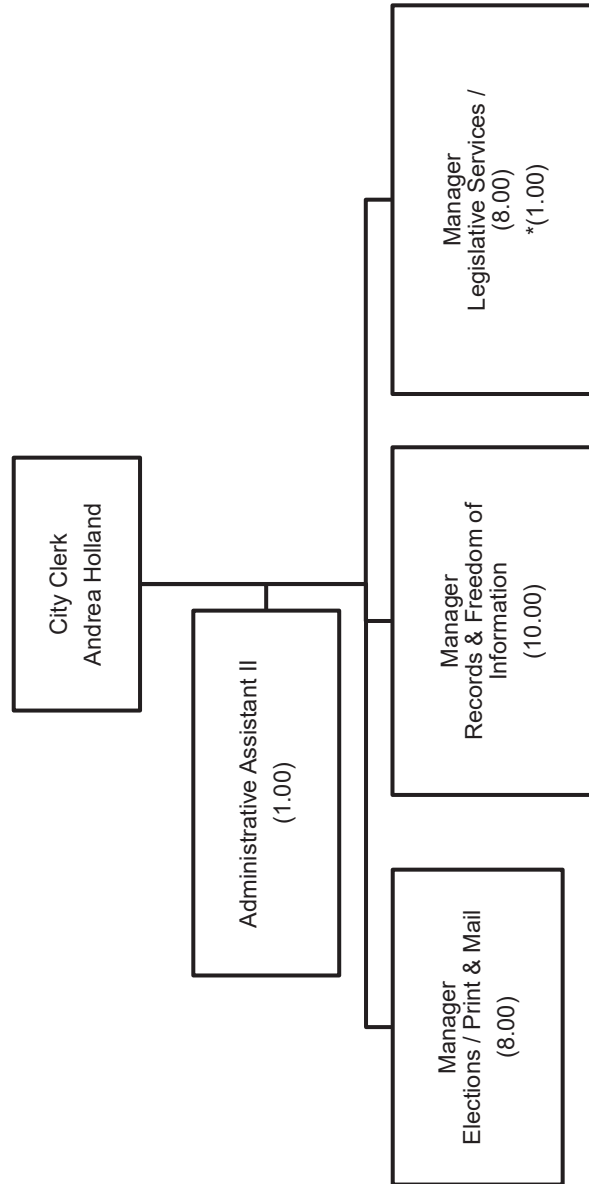

COMPLEMENT (FTE)	MANAGEMENT	OTHER	* OTHER DISTRIBUTED	TOTAL	STAFF/MGT RATIO
2019	4.00	24.00	1.00	29.00	6.25:1
2020	4.00	24.00	1.00	29.00	6.25:1
CHANGE	0.00	0.00	0.00	0.00	

* Represents distributed staff whose budget are in operating departments.

2020 Preliminary Tax Supported Operating Budget

BY SECTION

	2019 Restated Gross	2019 Restated Net	2019 Projected Net	2020 Preliminary Gross	2020 Preliminary Net	'20 Preli. vs. '19 Rest. (\$)	'20 Preli. vs. '19 Rest. (%)
City Clerk - Admin	325,380	325,380	96,630	388,410	388,410	63,030	19.4%
Elections	672,840	624,900	624,900	678,530	630,590	5,690	0.9%
Legislative Support	877,140	877,140	754,200	902,130	902,130	24,990	2.8%
Print & Mail	387,830	387,830	464,860	424,620	424,620	36,790	9.5%
Records	939,460	403,860	299,400	980,470	444,870	41,010	10.2%
Total City Clerk's Office	3,202,650	2,619,110	2,239,990	3,374,160	2,790,620	171,510	6.5%

BY COST CATEGORY

	2019 Restated Budget	2019 Projected Actual	2020 Preliminary Budget	'20 Preli. vs. '19 Rest. (\$)	'20 Preli. vs. '19 Rest. (%)
EMPLOYEE RELATED COST	2,508,370	2,226,750	2,575,940	67,570	2.7%
MATERIAL AND SUPPLY	814,820	882,720	832,570	17,750	2.2%
VEHICLE EXPENSES	11,280	11,280	10,550	(730)	(6.5%)
BUILDING AND GROUND	5,100	5,100	4,970	(130)	(2.5%)
CONTRACTUAL	88,540	88,540	88,540	0	0.0%
RESERVES / RECOVERIES	164,440	(44,800)	249,220	84,780	51.6%
COST ALLOCATIONS	(389,900)	(389,900)	(387,630)	2,270	0.6%
TOTAL EXPENDITURES	3,202,650	2,779,690	3,374,160	171,510	5.4%
FEES AND GENERAL	(535,600)	(542,600)	(535,600)	0	0.0%
RESERVES	(47,940)	2,900	(47,940)	0	0.0%
TOTAL REVENUES	(583,540)	(539,700)	(583,540)	0	0.0%
NET LEVY	2,619,110	2,239,990	2,790,620	171,510	6.5%

CUSTOMER SERVICE

DIVISION STRUCTURE

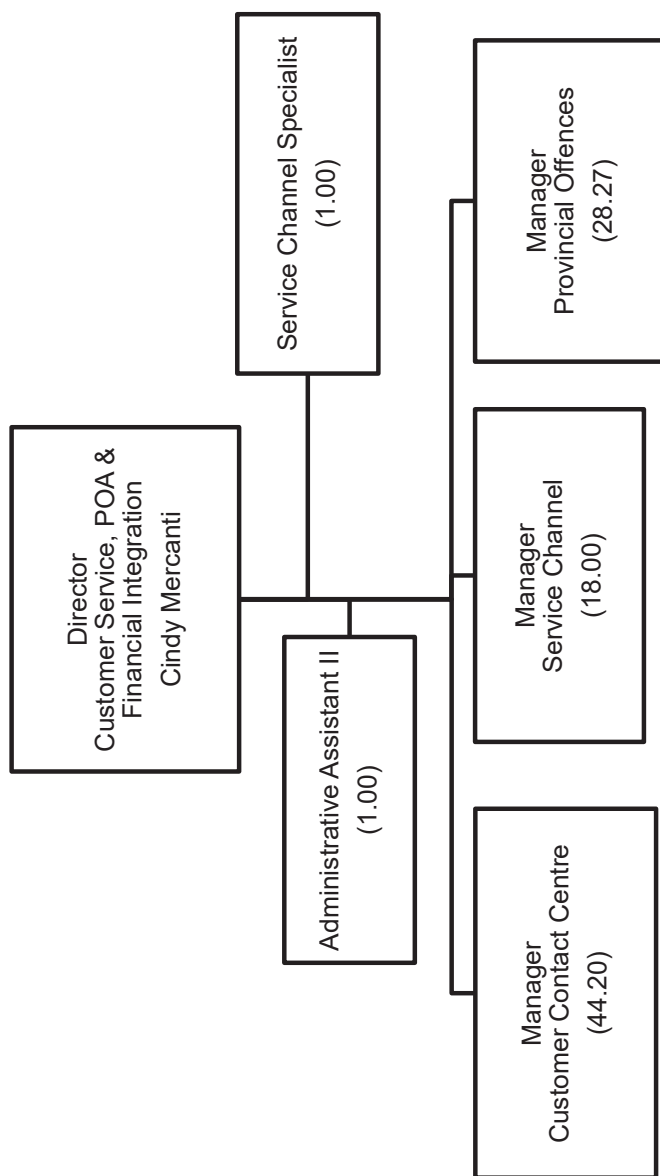

COMPLEMENT (FTE)	MANAGEMENT	OTHER	TOTAL	STAFF/MGT RATIO
2019	4.00	89.47	93.47	21.62:1
2020	4.00	89.47	93.47	21.62:1
CHANGE	0.00	0.00	0.00	

* Represents distributed staff whose budget are in operating departments.

2020 Preliminary Tax Supported Operating Budget

BY SECTION

	2019 Restated Gross	2019 Restated Net	2019 Projected Net	2020 Preliminary Gross	2020 Preliminary Net	'20 Preli. vs. '19 Rest. (\$)	'20 Preli. vs. '19 Rest. (%)
Customer Contact Centre	3,461,880	3,461,880	3,281,980	3,510,060	3,510,060	48,180	1.4%
Customer Service - Administration	294,250	294,250	364,450	300,580	300,580	6,330	2.2%
Provincial Offences Act	5,030,200	140,840	0	6,350,190	0	(140,840)	(100.0%)
Service Channel	1,658,370	1,658,370	1,643,860	1,714,330	1,714,330	55,960	3.4%
Total Customer Service	10,444,700	5,555,340	5,290,280	11,875,160	5,524,970	(30,370)	(0.5%)

BY COST CATEGORY

	2019 Restated Budget	2019 Projected Actual	2020 Preliminary Budget	'20 Preli. vs. '19 Rest. (\$)	'20 Preli. vs. '19 Rest. (%)
EMPLOYEE RELATED COST	7,586,990	7,408,710	7,699,070	112,080	1.5%
MATERIAL AND SUPPLY	186,640	137,350	187,140	500	0.3%
BUILDING AND GROUND	257,040	243,500	259,880	2,840	1.1%
CONSULTING	3,000	180	3,000	0	0.0%
CONTRACTUAL	299,610	240,620	319,910	20,300	6.8%
RESERVES / RECOVERIES	2,139,480	2,104,410	1,979,440	(160,040)	(7.5%)
COST ALLOCATIONS	(1,400,210)	(1,400,040)	(1,575,210)	(175,000)	(12.5%)
FINANCIAL	1,372,150	1,202,640	1,426,930	54,780	4.0%
CAPITAL FINANCING	0	0	1,575,000	1,575,000	100.0%
TOTAL EXPENDITURES	10,444,700	9,937,360	11,875,160	1,430,460	13.7%
FEES AND GENERAL	(4,889,360)	(4,647,080)	(6,350,190)	(1,460,830)	(29.9%)
TOTAL REVENUES	(4,889,360)	(4,647,080)	(6,350,190)	(1,460,830)	(29.9%)
NET LEVY	5,555,340	5,290,280	5,524,970	(30,370)	(0.5%)

FINANCIAL PLANNING,
ADMIN & POLICY

DIVISION STRUCTURE

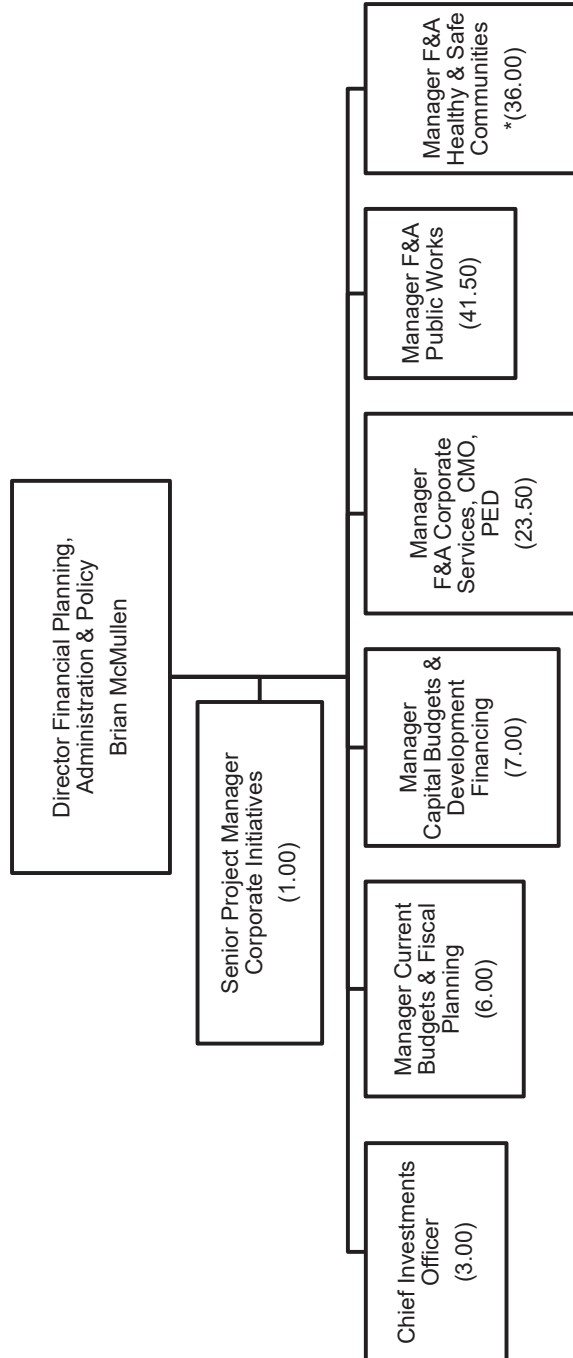

COMPLEMENT (FTE)	MANAGEMENT	*MANAGEMENT DISTRIBUTED	OTHER	* OTHER DISTRIBUTED	TOTAL	STAFF/MGT RATIO
2019	6.00	1.00	77.00	35.00	119.00	16:1
2020	6.00	1.00	77.00	35.00	119.00	16:1
CHANGE	0.00	0.00	0.00	0.00	0.00	

* Represents distributed staff whose budget are in operating departments

2020 Preliminary Tax Supported Operating Budget

BY SECTION

	2019 Restated Gross	2019 Restated Net	2019 Projected Net	2020 Preliminary Gross	2020 Preliminary Net	'20 Preli. vs. '19 Rest. (\$)	'20 Preli. vs. '19 Rest. (%)
Administration Fin Policy & Plan	67,940	66,020	165,230	84,900	81,870	15,850	24.0%
Capital Budget	1,018,050	(2,590)	0	1,041,120	0	2,590	(100.0%)
Current Budget	462,120	462,120	465,470	458,720	458,720	(3,400)	(0.7%)
Finance	4,509,450	4,419,120	4,250,430	4,586,540	4,494,390	75,270	1.7%
Investments	1,165,640	(127,410)	(126,080)	1,150,970	(120,490)	6,920	(5.4%)
Total Financial Planning, Admin & Policy	7,223,200	4,817,260	4,755,050	7,322,250	4,914,490	97,230	2.0%

BY COST CATEGORY

	2019 Restated Budget	2019 Projected Actual	2020 Preliminary Budget	'20 Preli. vs. '19 Rest. (\$)	'20 Preli. vs. '19 Rest. (%)
EMPLOYEE RELATED COST	8,207,120	8,044,030	8,385,190	178,070	2.2%
MATERIAL AND SUPPLY	42,880	42,880	42,880	0	0.0%
BUILDING AND GROUND	79,060	79,060	37,820	(41,240)	(52.2%)
CONSULTING	20,700	20,700	20,700	0	0.0%
CONTRACTUAL	81,210	97,350	81,210	0	0.0%
RESERVES / RECOVERIES	145,900	159,040	161,410	15,510	10.6%
COST ALLOCATIONS	(1,676,770)	(1,580,830)	(1,704,480)	(27,710)	(1.7%)
FINANCIAL	323,100	323,100	297,520	(25,580)	(7.9%)
TOTAL EXPENDITURES	7,223,200	7,185,340	7,322,250	99,050	1.4%
FEES AND GENERAL	(1,521,380)	(1,545,730)	(1,501,610)	19,770	1.3%
RESERVES	(105,500)	(105,500)	(105,500)	0	0.0%
RECOVERIES FROM CAPITAL	(779,060)	(779,060)	(800,650)	(21,590)	(2.8%)
TOTAL REVENUES	(2,405,940)	(2,430,290)	(2,407,760)	(1,820)	(0.1%)
NET LEVY	4,817,260	4,755,050	4,914,490	97,230	2.0%

FINANCIAL SERVICES

DIVISION STRUCTURE

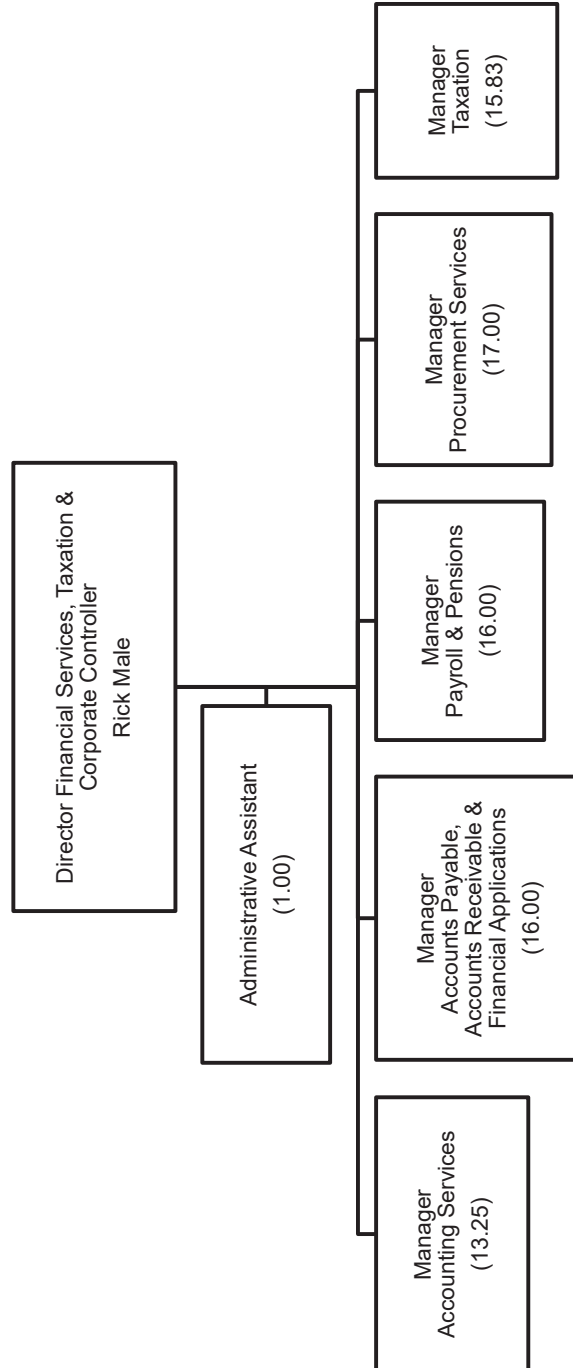

COMPLEMENT (FTE)	MANAGEMENT	OTHER	TOTAL	STAFF/MGT RATIO
2019	6.00	74.08	80.08	12.35:1
2020	6.00	74.08	80.08	12.35:1
CHANGE	0.00	0.00	0.00	

2020 Preliminary Tax Supported Operating Budget

BY SECTION

	2019 Restated Gross	2019 Restated Net	2019 Projected Net	2020 Preliminary Gross	2020 Preliminary Net	'20 Preli. vs. '19 Rest. (\$)	'20 Preli. vs. '19 Rest. (%)
Accounts Payable	435,530	394,530	394,530	479,460	438,460	43,930	11.1%
Accounts Receivables	159,370	159,370	159,370	168,670	168,670	9,300	5.8%
Financial Accounting Services	1,043,900	607,250	510,020	1,138,530	692,820	85,570	14.1%
Financial Application Support	333,760	333,760	333,760	367,260	367,260	33,500	10.0%
Financial Services Admin	316,630	316,630	432,940	377,010	377,010	60,380	19.1%
Payroll and Pensions	1,034,720	934,220	849,220	1,055,250	954,750	20,530	2.2%
Procurement	1,168,970	935,400	935,400	1,162,330	928,760	(6,640)	(0.7%)
Taxation	2,264,960	294,150	44,080	2,339,880	319,070	24,920	8.5%
Total Financial Services	6,757,840	3,975,310	3,659,320	7,088,390	4,246,800	271,490	6.8%

BY COST CATEGORY

	2019 Restated Budget	2019 Projected Actual	2020 Preliminary Budget	'20 Preli. vs. '19 Rest. (\$)	'20 Preli. vs. '19 Rest. (%)
EMPLOYEE RELATED COST	7,357,330	7,118,590	7,529,060	171,730	2.3%
MATERIAL AND SUPPLY	583,080	580,980	589,580	6,500	1.1%
BUILDING AND GROUND	482,340	482,340	16,510	(465,830)	(96.6%)
CONTRACTUAL	102,520	103,020	103,020	500	0.5%
RESERVES / RECOVERIES	264,240	268,510	437,590	173,350	65.6%
COST ALLOCATIONS	(2,096,470)	(2,096,470)	(1,955,170)	141,300	6.7%
FINANCIAL	64,800	64,800	64,800	0	0.0%
CAPITAL FINANCING	0	0	303,000	303,000	100.0%
TOTAL EXPENDITURES	6,757,840	6,521,770	7,088,390	330,550	4.9%
FEEES AND GENERAL	(1,831,720)	(1,837,220)	(1,861,720)	(30,000)	(1.6%)
TAX AND RATES	(380,000)	(500,000)	(400,000)	(20,000)	(5.3%)
RESERVES	(179,780)	(143,620)	(179,780)	0	0.0%
RECOVERIES FROM CAPITAL	(391,030)	(381,610)	(400,090)	(9,060)	(2.3%)
TOTAL REVENUES	(2,782,530)	(2,862,450)	(2,841,590)	(59,060)	(2.1%)
NET LEVY	3,975,310	3,659,320	4,246,800	271,490	6.8%

INFORMATION TECHNOLOGY

DIVISION STRUCTURE

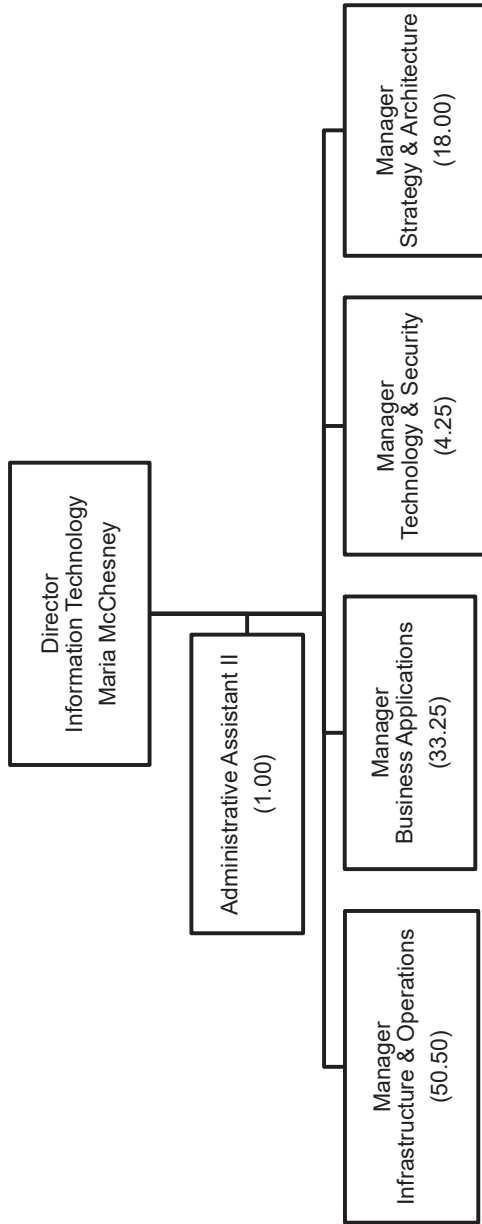

COMPLEMENT (FTE)	MANAGEMENT	OTHER	TOTAL	STAFF/MGT RATIO
2019	5.00	103.00	108.00	20.6:1
2020	5.00	103.00	108.00	20.6:1
CHANGE	0.00	0.00	0.00	

2020 Preliminary Tax Supported Operating Budget

BY SECTION

	2019 Restated Gross	2019 Restated Net	2019 Projected Net	2020 Preliminary Gross	2020 Preliminary Net	'20 Preli. vs. '19 Rest. (\$)	'20 Preli. vs. '19 Rest. (%)
Business Applications	6,334,770	6,329,210	5,516,300	6,449,420	6,443,860	114,650	1.8%
City Leased Equipment	4,481,250	0	0	4,481,250	0	0	0.0%
Equipment and Maintenance	5,000	5,000	5,000	5,000	5,000	0	0.0%
Infrastructure & Operations	8,059,730	7,974,730	7,962,830	8,193,630	8,108,630	133,900	1.7%
IP Telephony	2,850	0	0	1,170	0	0	0.0%
IT - Admin	(3,512,390)	(3,512,660)	(3,361,950)	(3,763,000)	(3,763,270)	(250,610)	7.1%
Technology & Security	698,170	698,170	698,170	709,170	709,170	11,000	1.6%
Total Information Technology	16,069,380	11,494,450	10,820,350	16,076,640	11,503,390	8,940	0.1%

BY COST CATEGORY

	2019 Restated Budget	2019 Projected Actual	2020 Preliminary Budget	'20 Preli. vs. '19 Rest. (\$)	'20 Preli. vs. '19 Rest. (%)
EMPLOYEE RELATED COST	11,289,100	10,747,830	11,545,990	256,890	2.3%
MATERIAL AND SUPPLY	5,770,360	5,589,060	7,543,760	1,773,400	30.7%
VEHICLE EXPENSES	6,760	6,210	5,270	(1,490)	(22.0%)
BUILDING AND GROUND	120,780	118,140	118,350	(2,430)	(2.0%)
CONSULTING	12,060	12,060	12,060	0	0.0%
CONTRACTUAL	3,690,170	3,747,490	3,708,610	18,440	0.5%
RESERVES / RECOVERIES	983,260	978,760	(792,090)	(1,775,350)	(180.6%)
COST ALLOCATIONS	(5,871,110)	(5,871,110)	(6,133,310)	(262,200)	(4.5%)
FINANCIAL	68,000	66,840	68,000	0	0.0%
TOTAL EXPENDITURES	16,069,380	15,395,280	16,076,640	7,260	0.0%
FEEES AND GENERAL	(93,680)	(93,680)	(92,000)	1,680	1.8%
RESERVES	(4,481,250)	(4,481,250)	(4,481,250)	0	0.0%
TOTAL REVENUES	(4,574,930)	(4,574,930)	(4,573,250)	1,680	0.0%
NET LEVY	11,494,450	10,820,350	11,503,390	8,940	0.1%

LEGAL SERVICES

DIVISION STRUCTURE

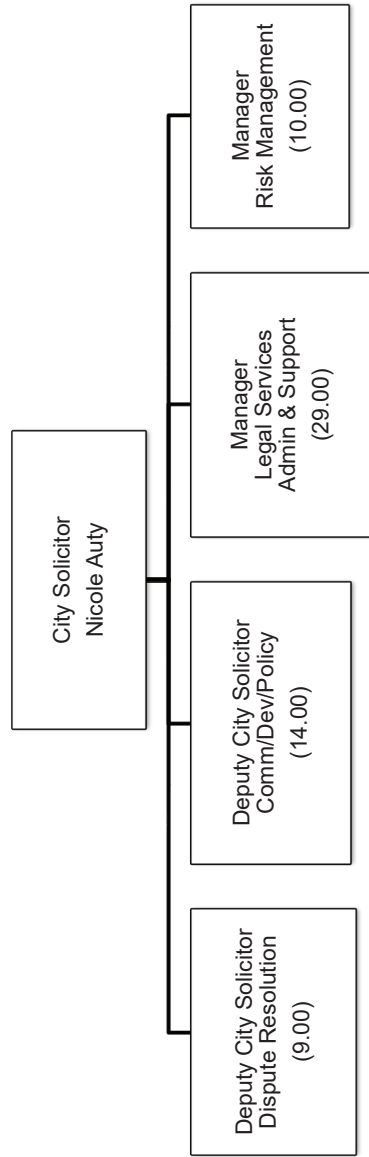

COMPLEMENT (FTE)	MANAGEMENT	OTHER	TOTAL	STAFF/MGT RATIO
2019	5.00	58.00	63.00	12.6:1
2020	5.00	58.00	63.00	12.6:1
CHANGE	0.00	0.00	0.00	

2020 Preliminary Tax Supported Operating Budget

BY SECTION

	2019 Restated Gross	2019 Restated Net	2019 Projected Net	2020 Preliminary Gross	2020 Preliminary Net	'20 Preli. vs. '19 Rest. (\$)	'20 Preli. vs. '19 Rest. (%)
Legal Services	4,394,110	3,505,470	3,382,750	4,404,990	3,416,350	(89,120)	(2.5%)
Total Legal Services	4,394,110	3,505,470	3,382,750	4,404,990	3,416,350	(89,120)	(2.5%)

BY COST CATEGORY

	2019 Restated Budget	2019 Projected Actual	2020 Preliminary Budget	'20 Preli. vs. '19 Rest. (\$)	'20 Preli. vs. '19 Rest. (%)
EMPLOYEE RELATED COST	7,742,550	7,682,110	7,911,240	168,690	2.2%
MATERIAL AND SUPPLY	124,490	131,650	131,950	7,460	6.0%
BUILDING AND GROUND	14,990	14,990	15,140	150	1.0%
CONSULTING	5,000	5,000	5,000	0	0.0%
CONTRACTUAL	45,850	98,050	45,850	0	0.0%
RESERVES / RECOVERIES	(3,236,860)	(3,368,910)	(3,453,900)	(217,040)	(6.7%)
COST ALLOCATIONS	(586,490)	(586,490)	(534,870)	51,620	8.8%
FINANCIAL	202,960	202,960	202,960	0	0.0%
CAPITAL FINANCING	81,620	81,620	81,620	0	0.0%
TOTAL EXPENDITURES	4,394,110	4,260,980	4,404,990	10,880	0.2%
FEEES AND GENERAL	(55,860)	(55,860)	(155,860)	(100,000)	(179.0%)
RECOVERIES FROM CAPITAL	(832,780)	(822,370)	(832,780)	0	0.0%
TOTAL REVENUES	(888,640)	(878,230)	(988,640)	(100,000)	(11.3%)
NET LEVY	3,505,470	3,382,750	3,416,350	(89,120)	(2.5%)

OTHERS



LEGISLATIVE

2020 Preliminary Tax Supported Operating Budget

BY SECTION

	2019 Restated Gross	2019 Restated Net	2019 Projected Net	2020 Preliminary Gross	2020 Preliminary Net	'20 Preli. vs. '19 Rest. (\$)	'20 Preli. vs. '19 Rest. (%)
Legislative General	(373,660)	(373,660)	(168,350)	(359,570)	(359,570)	14,090	(3.8%)
Mayors Office	1,118,300	1,118,300	1,133,660	1,164,020	1,164,020	45,720	4.1%
Volunteer Committee	142,160	112,650	112,650	112,650	112,650	0	0.0%
Ward Budgets	4,113,730	4,113,730	3,936,730	4,170,120	4,170,120	56,390	1.4%
Total Legislative	5,000,530	4,971,020	5,014,690	5,087,220	5,087,220	116,200	2.3%

BY COST CATEGORY

	2019 Restated Budget	2019 Projected Actual	2020 Preliminary Budget	'20 Preli. vs. '19 Rest. (\$)	'20 Preli. vs. '19 Rest. (%)
EMPLOYEE RELATED COST	4,075,980	4,075,840	4,165,200	89,220	2.2%
MATERIAL AND SUPPLY	988,640	811,640	960,220	(28,420)	(2.9%)
VEHICLE EXPENSES	5,620	5,620	5,000	(620)	(11.0%)
BUILDING AND GROUND	82,000	82,000	81,040	(960)	(1.2%)
CONSULTING	54,190	54,190	54,190	0	0.0%
CONTRACTUAL	219,530	392,720	219,530	0	0.0%
AGENCIES and SUPPORT PAYMENTS	19,070	19,070	19,070	0	0.0%
RESERVES / RECOVERIES	306,330	353,950	345,900	39,570	12.9%
COST ALLOCATIONS	(906,080)	(906,080)	(918,180)	(12,100)	(1.3%)
FINANCIAL	155,250	155,250	155,250	0	0.0%
TOTAL EXPENDITURES	5,000,530	5,044,200	5,087,220	86,690	1.7%
RESERVES	(29,510)	(29,510)	0	29,510	100.0%
TOTAL REVENUES	(29,510)	(29,510)	0	29,510	100.0%
NET LEVY	4,971,020	5,014,690	5,087,220	116,200	2.3%

CORPORATE FINANCIALS

2020 Preliminary Tax Supported Operating Budget

BY SECTION

	2019 Restated Gross	2019 Restated Net	2019 Projected Net	2020 Preliminary Gross	2020 Preliminary Net	'20 Preli. vs. '19 Rest. (\$)	'20 Preli. vs. '19 Rest. (%)
Corporate Initiatives	4,444,100	4,222,500	4,120,250	8,535,300	8,313,700	4,091,200	96.9%
Corporate Pensions, Benefits & Contingency	16,374,490	15,344,590	15,584,660	12,797,850	15,946,150	601,560	3.9%
Total Corporate Financials - Expenditures	20,818,590	19,567,090	19,704,910	21,333,150	24,259,850	4,692,760	24.0%

BY COST CATEGORY

	2019 Restated Budget	2019 Projected Actual	2020 Preliminary Budget	'20 Preli. vs. '19 Rest. (\$)	'20 Preli. vs. '19 Rest. (%)
EMPLOYEE RELATED COST	14,463,290	18,631,960	12,282,050	(2,181,240)	(15.1%)
MATERIAL AND SUPPLY	218,100	204,910	218,600	500	0.2%
CONSULTING	75,000	75,000	100,000	25,000	33.3%
CONTRACTUAL	974,140	974,140	1,440,560	466,420	47.9%
AGENCIES and SUPPORT PAYMENTS	20,000	20,000	20,000	0	0.0%
RESERVES / RECOVERIES	(10,930,010)	(10,930,010)	(9,414,550)	1,515,460	13.9%
FINANCIAL	15,080,470	15,219,720	15,768,890	688,420	4.6%
CAPITAL FINANCING	917,600	917,600	917,600	0	0.0%
TOTAL EXPENDITURES	20,818,590	25,113,310	21,333,150	514,560	2.5%
FEES AND GENERAL	(186,600)	(4,336,110)	(186,600)	0	0.0%
RESERVES	(1,064,900)	(1,072,300)	3,113,300	4,178,200	392.4%
TOTAL REVENUES	(1,251,500)	(5,408,410)	2,926,700	4,178,200	333.9%
NET LEVY	19,567,090	19,704,910	24,259,850	4,692,760	24.0%

OPERATING IMPACTS OF CAPITAL (2020 AND PRIOR)

	FCS18097		UPDATED		Comments
	\$ (000's)	FTE's	Annualized (\$ 000's)	2020 FTE	
City Manager					
Human Resources					
20519579703 Performance and Learning Management System	150.00	0.00	50.00	50.00	\$50k required for 2020; \$100k deferred to 2021
Total City Manager	150.00	0.00	50.00	50.00	
Planning & Economic Development					
Licensing and By-Law					
45019579900 Handheld Ticketing Device-System Integration	82.00	0.00	82.00	82.00	
Urban Renewal					
8201703706 Community Downtowns and BIA	11.00	0.00	11.00	11.00	
Planning Services					
8121957900 3D Model Development	3.00	0.00	0.00	0.00	Defer to 2021
Tourism and Culture					
7201841803 St. Mark's Interior Restoration	42.00	0.50	42.00	42.00	
Total Planning & Economic Development	138.00	0.50	135.00	135.00	
Healthy and Safe Communities					
Paramedic					
7641951102 Paramedic Helmet Replacement	17.00	0.00	17.00	17.00	
Total Healthy and Safe Communities	17.00	0.00	17.00	17.00	
Corporate Services					
Information Technology (IT)					
3501957905 Strategic Theme Enabling	235.00	0.00	235.00	235.00	
Customer Service & POA					
Corporate Wide Customer Experience Feedback	157.00	0.00	0.00	0.00	Defer to 2021
2051957901 Program	392.00	0.00	235.00	235.00	
Total Corporate Services	392.00	0.00	235.00	235.00	

OPERATING IMPACTS OF CAPITAL (2020 AND PRIOR)

	FCS18097		UPDATED		FTE	Comments
	\$ (000's)	FTE's	Annualized (\$ 000's)	2020		
Public Works Tax Funded						
Corporate Facilities						
3541849003 Backflow Prevention for Various Facilities	120.00	0.00	120.00	120.00	0.00	
Sub-Total Corporate Facilities	120.00	0.00	120.00	120.00	0.00	
Recreation Facilities						
7101841800 Parks North Yard at Bayfront Park	30.00	0.00	0.00	0.00	0.00	Defer to 2021
Sub-Total Recreation Facilities	30.00	0.00	0.00	0.00	0.00	
Forestry & Horticulture						
4451953444 Tree Planting Program	67.40	0.00	67.40	67.40	0.00	
Sub-Total Forestry & Horticulture	67.40	0.00	67.40	67.40	0.00	
O & M - Parks & Cemeteries						
4401956001 Leash free Dog Park Program	5.00	0.00	5.00	5.00	0.00	
4401951601 Equipment Acquisition (DC) Program	75.00	0.00	75.00	75.00	0.00	
Sub-Total O & M - Parks & Cemeteries	80.00	0.00	80.00	80.00	0.00	
Open Space Development						
Open Space Replacement Strategy-East Mtn Trail	0.20				0.20	
4401056060 Loop	18.50		18.50	18.50		
4401356801 Confederation Park Redevelopment	291.00	3.66	291.00	291.00	3.66	
Heritage Green Community Sports Park	12.80	0.20	12.80	12.80	0.20	
4401556503 Implementation						
4401756718 Ancaster Meadows Park	23.50	0.25	23.50	23.50	0.25	
4401856601 Legislated Monitoring	21.00	0.25	0.00	0.00	0.00	Cancelled
4401856806 Bookjans West Proposed Park - Ancaster Glen	20.50	0.20	20.50	20.50	0.20	
4401956902 Red Hill Phase 3 and 4 Park	18.50	0.15	0.00	0.00	0.00	Defer to 2021
4401956903 Stonechurch Road Trail Link @ Dartnall	16.00	0.20	16.00	16.00	0.20	
4401956921 Johnson Tew Planting	15.00	0.33	15.00	15.00	0.33	
4401956925 City Hall Peace Garden	28.00	0.33	28.00	28.00	0.33	
4401956802 Beach Park Development Program	3.00	0.00	3.00	3.00	0.00	
4401956922 Alexander Park Skate Park	15.00	0.00	15.00	15.00	0.00	
HRTMP Initiative 15-7: Highway 5 - Mountain	15.00		15.00	15.00		
4401956933 Brow Link		0.00			0.00	
4401956910 Ancaster Soccer Improvements	6.00	0.00	6.00	6.00	0.00	
4401756703 Mountain Brow Path	4.80	0.00	4.80	4.80	0.00	
Sub-Total Open Space Development	508.60	5.77	469.10	469.10	5.37	

OPERATING IMPACTS OF CAPITAL (2020 AND PRIOR)

	FCS18097		UPDATED		FTE	Comments
	\$ (000's)	FTE's	Annualized (\$ 000's)	2020		
Roads, Bridges, Sidewalks, Traffic						
4031980941 New Traffic Signal - Dundas at Pamela/Riverwalk	30.00	0.20	30.00	30.00	0.20	
4031980942 Dundas at Mallard Trail/Springcreek	30.00	0.20	30.00	30.00	0.20	
4031980988 Fruitland Road By-pass - Barton to Hwy 8	60.00	0.30	0.00	0.00	0.00	Defer to 2021
4661817124 On Street Bike Facilities	73.00	0.50	73.00	73.00	0.50	
4661820821 New Traffic Signal - Drakes @ North Service Rd	30.00	0.20	30.00	30.00	0.20	
ATMS – Advanced Traffic Management System	204.00	2.00	204.00	204.00	2.00	
4661920001						
4661920008 New Traffic Signal Installation Program	117.00	0.80	117.00	117.00	0.80	
4661920525 IPS - Intersection Pedestrian Signal	30.00	0.20	30.00	30.00	0.20	
4661920531 APS - Accessible Pedestrian Signals	63.00	0.60	63.00	63.00	0.60	
New Traffic Signal - Waterdown Rd/Mill St @ Mountain	30.00	0.20	0.00	0.00	0.00	Defer to 2021
New Traffic Signal - Rymal Rd west of Walmart	30.00	0.20	30.00	30.00	0.20	
4661920922 Access						
4661920923 New Traffic Signal - RR 56 at Daigliesh Rd	30.00	0.20	30.00	30.00	0.20	
4661920924 New Traffic Signal - Hughson at Hunter	30.00	0.20	30.00	30.00	0.20	
New Traffic Signal - Rymal at Canadian Tire	30.00	0.20	30.00	30.00	0.20	
4661920926 Access						
New Traffic Signal - Rymal (opposite Celestial Crescent)	30.00	0.20	30.00	30.00	0.20	
4661920927	7.70		7.70	7.70		
Fleet Additions - Engineering Services - Construction		0.00			0.00	
4031921960	-600.00	0.00	0.00	0.00	0.00	
4041610018 Low-Wattage Street Lighting LED Replacement						Savings captured in PW's 2020 Base Budget
Sub-Total Roads, Bridges, Sidewalks, Traffic	224.70	6.20	734.70	734.70	5.70	
Transit Services						
5301985901 Transit Terminal Development	20.00	0.00	0.00	0.00	0.00	Defer
Express Bus (L-A-S-T Lines) Enhanced Passenger Amenities	90.00		90.00	90.00		
5301785702		0.00			0.00	
5301984901 Corridor Capacity	50.00	0.00	0.00	0.00	0.00	Defer
Sub-Total Transit Services	160.00	0.00	90.00	90.00	0.00	
Waste Management						
5121951900 Waste Collection Equipment - Downtown/BIA	30.00	0.00	30.00	30.00	0.00	
Sub-Total Waste Management	30.00	0.00	30.00	30.00	0.00	
West Harbour & Waterfront Strategic Initiatives						
4411606102 Pier 5-7 Boardwalk	72.00	0.33	0.00	0.00	0.00	Defer to 2021
Sub-Total West Harbour & Waterfront Strategic Initiatives	72.00	0.33	0.00	0.00	0.00	
Total Public Works Tax Funded	1,292.70	12.30	1,591.20	1,591.20	11.07	
Total (FCS18097)	1,989.70	12.80	2,028.20	2,028.20	11.57	

OPERATING IMPACTS OF CAPITAL (2020 AND PRIOR)

	FCS19091		UPDATED		FTE	Comments
	\$ (000's)	FTE's	Annualized (\$ 000's)	2020		
2020 impacts submitted for approval during 2020 budget process:						
Corporate Services						
Information Technology (IT)						
3501957903 IT Strategy - Strategic Theme Mobility	15.00	0.00	15.00	15.00	0.00	
Total (FCS19091)	15.00	0.00	15.00	15.00	0.00	
2019 impacts (from 2018 Capital) Deferred to 2020:						
West Harbour & Waterfront Strategic Initiatives						
4411506107 Pier 5-7 Marina Shoreline Rehab	20.00	0.00	0.00	0.00	0.00	Defer to 2021
4411606102 Pier 5-7 Boardwalk	72.01	0.33	0.00	0.00	0.00	Defer to 2021
4411606104 Pier 7 Commercial Village	139.20	1.26	0.00	0.00	0.00	Defer to 2021
4411606105 Pier 8 Shorewall	20.00	0.00	0.00	0.00	0.00	Defer to 2021
4411606106 Pier 8 Promenade	439.03	4.32	0.00	0.00	0.00	Defer to 2021
4411706102 Pier 8 Park	161.26	0.60	0.00	0.00	0.00	Defer to 2021
4411806201 Central Park Redevelopment	51.00	0.66	0.00	0.00	0.00	Defer to 2021
Corporate Facilities						
3541849003 Backflow Prevention for Various Facilities	120.00	0.00	120.00	120.00	0.00	
Transit Services						
5301785702 Express Bus (L-A-S-T Lines) Enhanced Passenger Amenities	12.00	0.00	12.00	12.00	0.00	
O & M - Parks & Cemeteries						
7101841800 Parks North Yard at Bayfront Park	30.00	0.00	0.00	0.00	0.00	Defer to 2021
7101854807 Dundas Valley Community Park Improvement & Pavilion Feasibility	6.00	0.00	0.00	0.00	0.00	Delete
4401849802 Heritage Green Maintenance Building Site Works	15.00	0.00	15.00	15.00	0.00	
Recreation Facilities						
7101558501 Parkdale Outdoor Pool Redevelopment	30.00	0.00	30.00	30.00	0.00	
Police Services						
3761851802 Ice Rescue Equipment	9.50	0.00	0.00	0.00	0.00	Defer to 2021
Entertainment Facilities						
3721851801 First Ontario Centre Vertical Transportation	45.00	0.00	45.00	45.00	0.00	

OPERATING IMPACTS OF CAPITAL (2020 AND PRIOR)

	Other Deferred		UPDATED		FTE	Comments
	\$ (000's)	FTE's	Annualized (\$ 000's)	2020		
2018 impacts (from 2017 Capital) Deferred to 2019:						
West Harbour & Waterfront Strategic Initiatives						
4411606104 Pier 7 Commercial Village	130.00	0.00	0.00	0.00	0.00	Defer to 2021
4411606103 Pier 6 Artisan Village	33.00	0.00	0.00	0.00	0.00	Defer to 2021
2017 Impacts (from 2016 Capital) Deferred to 2018:						
Recreation Facilities						
7101654609 Greensville Recreation Centre/School	53.00	0.00	0.00	0.00	0.00	Defer to 2021
7101654603 Beverly Recreation Centre/School	53.00	0.00	53.00	53.00	0.00	
2016 Impacts (from 2015 Capital) Deferred to 2017:						
Roads						
4041520510 Traffic Management System - Lincoln Alexander Parkway	90.00	1.00	0.00	0.00	0.00	Project is parked
2015 Impacts (from 2014 Capital) Deferred to 2016:						
Roads						
4041420110 Traffic Management System - Lincoln Alexander Parkway	160.00	2.00	0.00	0.00	0.00	Project is parked
2012 Impacts (from 2011 Capital) Deferred to 2015:						
Recreation						
7101141501 Winona Seniors Centre Expansion	10.00	1.00	0.00	0.00	0.00	Parked by Council
Total Deferred from Previous Years	1,699.00	11.17	275.00	275.00	0.00	
GRAND TOTAL	3,703.70	23.97	2,318.20	2,318.20	11.57	

HAMILTON ENTERTAINMENT FACILITIES

2020 Preliminary Tax Supported Operating Budget

BY SECTION

	2019 Restated Gross	2019 Restated Net	2019 Projected Net	2020 Preliminary Gross	2020 Preliminary Net	'20 Preli. vs. '19 Rest. (\$)	'20 Preli. vs. '19 Rest. (%)
Contract Management	1,516,620	1,456,620	1,447,620	1,861,620	1,797,620	341,000	23.4%
Mgr:Carmen Group	622,040	476,020	582,080	730,230	705,230	229,210	48.2%
Mgr:Global Spectrum	2,241,700	1,979,750	2,048,310	2,275,110	1,998,340	18,590	0.9%
Total Hamilton Entertainment Facilities	4,380,360	3,912,390	4,078,010	4,866,960	4,501,190	588,800	15.0%

BY COST CATEGORY

	2019 Restated Budget	2019 Projected Actual	2020 Preliminary Budget	'20 Preli. vs. '19 Rest. (\$)	'20 Preli. vs. '19 Rest. (%)
BUILDING AND GROUND	1,994,760	2,169,380	2,020,940	26,180	1.3%
CONTRACTUAL	1,472,000	1,467,000	1,917,000	445,000	30.2%
RESERVES / RECOVERIES	913,600	913,600	929,020	15,420	1.7%
TOTAL EXPENDITURES	4,380,360	4,549,980	4,866,960	486,600	11.1%
FEES AND GENERAL	(467,970)	(471,970)	(365,770)	102,200	21.8%
TOTAL REVENUES	(467,970)	(471,970)	(365,770)	102,200	21.8%
NET LEVY	3,912,390	4,078,010	4,501,190	588,800	15.0%

CAPITAL FINANCING

2020 Preliminary Tax Supported Operating Budget

BY DIVISION

	2019 Restated Gross	2019 Restated Net	2019 Projected Net	2020 Preliminary Gross	2020 Preliminary Net	'20 Prel. Net vs. '19 Rest. Net (\$)	'20 Prel. Net vs. '19 Rest. Net
Debt-Healthy & Safe Communities	5,675,260	2,339,720	4,409,570	5,675,260	2,339,720	0	0.0%
Debt-Infrastructure Renewal Levy	13,428,870	13,428,870	13,428,870	13,428,870	13,428,870	0	0.0%
Debt-Corporate Financials	74,224,300	74,224,300	71,112,580	83,769,300	83,769,300	9,545,000	12.9%
Debt-Planning & Economic Development	255,250	194,070	88,360	255,250	194,070	0	0.0%
Debt-Public Works	45,397,280	38,695,920	35,077,860	45,397,280	38,695,920	0	0.0%
Total City Depts Capital Financing	138,980,960	128,882,880	124,117,230	148,525,960	138,427,880	9,545,000	7.4%

BY COST CATEGORY

	2019 Restated Budget	2019 Projected Actual	2020 Preliminary Budget	'20 Preli. vs. '19 Rest. (\$)	'20 Preli. vs. '19 Rest. (%)
RESERVES / RECOVERIES	13,428,870	13,428,870	13,428,870	0	0.0%
CAPITAL FINANCING	125,552,090	120,786,440	135,097,090	9,545,000	7.6%
TOTAL EXPENDITURES	138,980,960	134,215,310	148,525,960	9,545,000	6.9%
GRANTS AND SUBSIDIES	(408,000)	(408,000)	(408,000)	0	0.0%
RESERVES	(9,690,080)	(9,690,080)	(9,690,080)	0	0.0%
TOTAL REVENUES	(10,098,080)	(10,098,080)	(10,098,080)	0	0.0%
NET LEVY	128,882,880	124,117,230	138,427,880	9,545,000	7.4%

LIBRARY

2020 Preliminary Tax Supported Operating Budget

BY DIVISION

	2019 Restated Gross	2019 Restated Net	2019 Projected Net	2020 Preliminary Gross	2020 Preliminary Net	'20 Prel. Net vs. '19 Rest. Net (\$)	'20 Prel. Net vs. '19 Rest. Net
Digital Technology & Creation	3,905,320	3,729,020	3,728,880	4,140,950	3,944,650	215,630	5.8%
Human Resources & Information Services	2,439,450	2,385,050	2,385,050	2,366,030	2,348,030	(37,020)	(1.6%)
Collections & Program Development	5,210,360	4,942,520	4,940,460	5,407,690	5,113,850	171,330	3.5%
Finance and Facilities	2,891,780	2,891,780	2,891,640	2,959,540	2,959,540	67,760	2.3%
Library Administration	814,900	814,900	814,900	820,310	820,310	5,410	0.7%
Library System	4,643,890	3,621,590	3,621,590	4,598,400	3,604,230	(17,360)	(0.5%)
Public Service - Branches	12,607,660	12,315,580	12,317,360	12,810,720	12,538,640	223,060	1.8%
Inactive	310	310	310	350	350	40	12.9%
Total Library	32,513,670	30,700,750	30,700,190	33,103,990	31,329,600	628,850	2.0%

BY COST CATEGORY

	2019 Restated Budget	2019 Projected Actual	2020 Preliminary Budget	'20 Preli. vs. '19 Rest. (\$)	'20 Preli. vs. '19 Rest. (%)
EMPLOYEE RELATED COST	22,007,750	22,005,410	22,299,290	291,540	1.3%
MATERIAL AND SUPPLY	3,853,880	3,853,880	3,750,780	(103,100)	(2.7%)
VEHICLE EXPENSES	82,790	82,790	85,640	2,850	3.4%
BUILDING AND GROUND	2,452,820	2,452,820	2,462,190	9,370	0.4%
CONTRACTUAL	1,367,980	1,367,980	1,529,710	161,730	11.8%
RESERVES / RECOVERIES	2,128,150	2,129,930	2,353,060	224,910	10.6%
COST ALLOCATIONS	233,080	233,080	232,600	(480)	(0.2%)
FINANCIAL	387,220	387,220	390,720	3,500	0.9%
TOTAL EXPENDITURES	32,513,670	32,513,110	33,103,990	590,320	1.8%
FEEES AND GENERAL	(620,470)	(620,470)	(554,940)	65,530	10.6%
GRANTS AND SUBSIDIES	(1,192,450)	(1,192,450)	(1,219,450)	(27,000)	(2.3%)
TOTAL REVENUES	(1,812,920)	(1,812,920)	(1,774,390)	38,530	2.1%
NET LEVY	30,700,750	30,700,190	31,329,600	628,850	2.0%

BOARDS AND AGENCIES

2020 Preliminary Tax Supported Operating Budget

BY DIVISION

	2019 Restated Gross	2019 Restated Net	2019 Projected Net	2020 Preliminary Gross	2020 Preliminary Net	'20 Prel. Net vs. '19 Rest. Net (\$)	'20 Prel. Net vs. '19 Rest. Net
Conservation Authorities	5,497,900	5,497,900	8,025,760	8,178,740	8,178,740	2,680,840	48.8%
Other Agencies							
Farmers Market	821,480	112,800	132,610	805,460	112,800	0	0.0%
Hamilton Beach Rescue Unit	134,340	134,340	134,340	134,340	134,340	0	0.0%
MPAC	6,715,220	6,715,220	6,715,220	6,849,520	6,849,520	134,300	2.0%
Royal Botanical Gardens	634,720	634,720	634,720	634,720	634,720	0	0.0%
Total Other Agencies	8,305,760	7,597,080	7,616,890	8,424,040	7,731,380	134,300	1.8%
Total Boards and Agencies	13,803,660	13,094,980	15,642,650	16,602,780	15,910,120	2,815,140	21.5%

BY COST CATEGORY

	2019 Restated Budget	2019 Projected Actual	2020 Preliminary Budget	'20 Preli. vs. '19 Rest. (\$)	'20 Preli. vs. '19 Rest. (%)
EMPLOYEE RELATED COST	321,960	321,960	325,070	3,110	1.0%
MATERIAL AND SUPPLY	30,150	25,310	27,550	(2,600)	(8.6%)
BUILDING AND GROUND	211,100	196,100	182,580	(28,520)	(13.5%)
CONTRACTUAL	6,809,450	6,804,420	6,938,720	129,270	1.9%
AGENCIES and SUPPORT PAYMENTS	6,199,190	8,727,050	8,880,030	2,680,840	43.2%
RESERVES / RECOVERIES	176,160	176,160	181,140	4,980	2.8%
COST ALLOCATIONS	46,200	46,200	52,240	6,040	13.1%
FINANCIAL	9,450	10,450	10,450	1,000	10.6%
CAPITAL EXPENDITURES	0	28,500	5,000	5,000	100.0%
TOTAL EXPENDITURES	13,803,660	16,336,150	16,602,780	2,799,120	20.3%
FEES AND GENERAL	(708,680)	(693,500)	(692,660)	16,020	2.3%
TOTAL REVENUES	(708,680)	(693,500)	(692,660)	16,020	2.3%
NET LEVY	13,094,980	15,642,650	15,910,120	2,815,140	21.5%

CITY ENRICHMENT FUND

2020 Preliminary Tax Supported Operating Budget

BY SECTION

	2019 Restated Gross	2019 Restated Net	2019 Projected Net	2020 Preliminary Gross	2020 Preliminary Net	'20 Preli. vs. '19 Rest. (\$)	'20 Preli. vs. '19 Rest. (%)
Administration CEF	50,000	50,000	50,000	50,000	50,000	0	0.0%
Agriculture	143,360	143,360	143,360	143,360	143,360	0	0.0%
Arts	2,770,540	2,770,540	2,770,540	2,770,540	2,770,540	0	0.0%
Communities Culture and Heritage	564,970	564,970	564,970	564,970	564,970	0	0.0%
Community Services	2,164,360	2,164,360	2,164,360	2,164,360	2,164,360	0	0.0%
Environment	146,390	146,390	146,390	146,390	146,390	0	0.0%
Sports & Active Lifestyles	245,990	245,990	276,270	245,990	245,990	0	0.0%
Total City Enrichment Fund	6,085,610	6,085,610	6,115,890	6,085,610	6,085,610	0	0.0%

BY COST CATEGORY

	2019 Restated Budget	2019 Projected Actual	2020 Preliminary Budget	'20 Preli. vs. '19 Rest. (\$)	'20 Preli. vs. '19 Rest. (%)
MATERIAL AND SUPPLY	50,000	50,000	50,000	0	0.0%
AGENCIES and SUPPORT PAYMENTS	6,035,610	6,065,890	6,035,610	0	0.0%
TOTAL EXPENDITURES	6,085,610	6,115,890	6,085,610	0	0.0%
TOTAL REVENUES	0	0	0	0	0.0%
NET LEVY	6,085,610	6,115,890	6,085,610	0	0.0%

NON PROGRAM REVENUES

2020 Preliminary Tax Supported Operating Budget

BY DIVISION

	2019 Restated Gross	2019 Restated Net	2019 Projected Net	2020 Preliminary Gross	2020 Preliminary Net	'20 Prel. Net vs. '19 Rest. Net (\$)	'20 Prel. Net vs. '19 Rest. Net
POA Levy Contribution	0	(2,362,200)	(2,362,200)	0	(2,302,380)	59,820	(2.5%)
Corporate Revenues	8,800,000	(14,400,000)	(14,047,000)	10,256,060	(13,902,940)	497,060	(3.5%)
Tax Adjustments	11,075,400	(28,202,300)	(30,462,100)	10,865,000	(29,512,300)	(1,310,000)	4.6%
Total Non Program Revenues	19,875,400	(44,964,500)	(46,871,300)	21,121,060	(45,717,620)	(753,120)	1.7%

BY COST CATEGORY

	2019 Restated Budget	2019 Projected Actual	2020 Preliminary Budget	'20 Preli. vs. '19 Rest. (\$)	'20 Preli. vs. '19 Rest. (%)
CONTRACTUAL	0	353,000	156,060	156,060	100.0%
FINANCIAL	11,075,400	10,603,230	10,865,000	(210,400)	(1.9%)
CAPITAL FINANCING	8,800,000	8,800,000	10,100,000	1,300,000	14.8%
TOTAL EXPENDITURES	19,875,400	19,756,230	21,121,060	1,245,660	6.3%
FEES AND GENERAL	(36,160,200)	(37,648,200)	(37,559,380)	(1,399,180)	(3.9%)
TAX AND RATES	(28,679,700)	(28,979,330)	(29,279,300)	(599,600)	(2.1%)
TOTAL REVENUES	(64,839,900)	(66,627,530)	(66,838,680)	(1,998,780)	(3.1%)
NET LEVY	(44,964,500)	(46,871,300)	(45,717,620)	(753,120)	(1.7%)

APPENDIX 6

**2020
Preliminary
Tax Supported
Operating Budget
Council Referred
Items**

COUNCIL REFERRED ITEMS SUMMARY

FORM #	DIVISION	SERVICE / PROGRAM	DESCRIPTION OF REFERRED ITEM	2020 IMPACT		FTE Impact
				\$ GROSS	\$ NET	
PLANNING & ECONOMIC DEVELOPMENT						
CR-01	Licensing & By-Law Services	By-law Enforcement	Cigarette Butt By-law Enforcement Officer	\$ 45,000	\$ 45,000	0.50
CR-02	Licensing & By-Law Services	By-law Enforcement	Hess Village Paid Duty Policing (PED18081(a))	TBD	TBD	0.00
PLANNING & ECONOMIC DEVELOPMENT SUBTOTAL				\$ 45,000	\$ 45,000	0.50
HEALTHY AND SAFE COMMUNITIES						
CR-03	Hamilton Fire Department	Hamilton Fire Department	10 Year Fire Service Delivery Plan	\$ 610,420	\$ 572,420	14.00
CR-04	Recreation	Recreation Facilities, Products and Services	Enhancement for CANUSA Funding	\$ 10,920	\$ 10,920	0.00
HEALTHY AND SAFE COMMUNITIES SUBTOTAL				\$ 621,340	\$ 583,340	14.00
PUBLIC WORKS - TAX						
CR-05	Transportation Operations & Maintenance	Roadway Access	Sidewalk Clearing Program	\$ -	TBD	TBD
CR-06	Transportation Operations & Maintenance	Roadway Access	Snow Angels Program (Council Referred Item)	\$ -	TBD	TBD
PUBLIC WORKS - TAX SUBTOTAL				\$ -	TBD	0.00

COUNCIL REFERRED ITEMS SUMMARY

FORM #	DIVISION	SERVICE / PROGRAM	DESCRIPTION OF REFERRED ITEM	2020 IMPACT		FTE Impact
				\$ GROSS	\$ NET	
CITY MANAGER						
CR-07	Strategic Partnerships & Communications	City Enrichment Fund	City Enrichment Fund	\$ 2,730	\$ 2,730	0.00
CR-08	Human Resources	Human Resources	Implement Living Wage Over Three Year Period	\$ 490,000	\$ 490,000	0.00
CITY MANAGER SUBTOTAL				\$ 492,730	\$ 492,730	0.00
CORPORATE SERVICES						
CR-09	Financial Planning, Admin & Policy	Financial Management	Establish Climate Change Reserve for Sustainable Funding	TBD	TBD	0.00
CORPORATE SERVICES SUBTOTAL				\$ -	\$ -	0.00
TOTAL				\$ 1,159,070	\$ 1,121,070	14.50

CITY OF HAMILTON

2020 OPERATING BUDGET COUNCIL REFERRED ITEMS

COUNCIL REFERRED ITEM #CR-01

OVERVIEW	
Request Title	Cigarette Butt By-law Enforcement Officer
Department	Planning & Economic Development
Division	Licensing & By-Law Services
Service	By-law Enforcement
Proposed Start Date	January - 2020
Strategic Plan Priorities	Healthy and Safe Communities

2020 OPERATING BUDGET FINANCIAL IMPACTS		
DESCRIPTION	2020 AMOUNT	ANNUALIZED AMOUNT
Total Expenditures	\$45,000	\$45,000
Total Revenue	\$0	\$0
Net Levy	\$45,000	\$45,000
Full Time Equivalent (FTE)	0.5	0.5
Capital Budget Impact	\$0	\$0

COUNCIL REFERRED ITEM #CR-01

BACKGROUND

On September 26, 2018 Council approved:

- (a) Report PED18154(a) respecting Cigarette Butt Litter Enforcement be received;
- (b) That the request ...that offers a part time Municipal Law Enforcement Officer dedicated solely to enforcing cigarette butt litter be referred to the 2019 Budget process; and,
- (c) That in the event Council approves this pilot, the awareness campaign include warnings of pending enforcement of cigarette butt littering.

Without the added position, it would be not be possible to maintain the increased workload of the council motion and there would be an impact on other services and Municipal Law Enforcements ability to respond in a timely manner.

DESCRIPTION

That .5 FTE Municipal By-Law Enforcement Officer (MLEO) be hired to enforce cigarette butt littering following a nine-month awareness campaign for a one-year pilot program with a cost of \$45, 000.

CITY OF HAMILTON

2020 OPERATING BUDGET COUNCIL REFERRED ITEMS

COUNCIL REFERRED ITEM #CR-02

OVERVIEW	
Request Title	Hess Village Paid Duty Policing (PED18081(a))
Department	Planning & Economic Development
Division	Licensing & By-Law Services
Service	By-law Enforcement
Proposed Start Date	January - 2020
Strategic Plan Priorities	Healthy and Safe Communities

2020 OPERATING BUDGET FINANCIAL IMPACTS		
DESCRIPTION	2020 AMOUNT	ANNUALIZED AMOUNT
Total Expenditures	TBD	\$50,000
Total Revenue	\$0	\$0
Net Levy	TBD	\$50,000
Full Time Equivalent (FTE)	0.0	0.0
Capital Budget Impact	\$0	\$0

COUNCIL REFERRED ITEM #CR-02

BACKGROUND

On April 25, 2018, Council approved Item 4 of Planning Committee Report 18-006 in response to Hess Village Paid Duty Policing Report (PED18081), Council resolved:

- (a) That the Hess Village Licence Holders' portion of the 2018 Paid Duty fee of approximately 50K be funded one-time from the Tax Stabilization Reserve; and,
- (b) That this portion of the Paid Duty fee be referred to the City of Hamilton and the Hamilton Police Service's 2019 budget process.

The Hamilton Police Services believes that a robust staffing plan beyond Divisional patrol response continues to be warranted for the Hess Village operational season. Without this enhancement, the Licence holders would be responsible for their share of the proportional billing. Several new establishments are now at Hess Village and the exemption of a restaurant versus a tavern/bar will need to be eliminated.

DESCRIPTION

At the February 8, 2019 General Issues Committee (Budget) meeting, the item respecting Hess Village Paid Duty Policing, in the amount of \$50,000, was deferred pending information from staff regarding the actual costs for the Hess Village Paid Duty Policing in 2018.

CITY OF HAMILTON

2020 OPERATING BUDGET COUNCIL REFERRED ITEMS

COUNCIL REFERRED ITEM #CR-03

OVERVIEW	
Request Title	10 Year Fire Service Delivery Plan
Department	Healthy and Safe Communities
Division	Hamilton Fire Department
Service	Hamilton Fire Department
Proposed Start Date	January - 2020
Strategic Plan Priorities	Healthy and Safe Communities

2020 OPERATING BUDGET FINANCIAL IMPACTS		
DESCRIPTION	2020 AMOUNT	ANNUALIZED AMOUNT
Total Expenditures	\$610,420	\$1,465,000
Total Revenue	\$38,000	\$91,200
Net Levy	\$572,420	\$1,373,800
Full Time Equivalent (FTE)	14.0	14.0
Capital Budget Impact	\$0	\$0

COUNCIL REFERRED ITEM #CR-03

BACKGROUND

10 Year Fire Service Delivery Plan approved by Council in June 2019 (HSC19026).

The Hamilton Fire Department Service Delivery Plan is guided by four principles; Principle #4, Reduce Risk for a Healthier and Safer Community is the driving principle for Council Referred Item CR-03. At present, during an incident, scene safety and accountability are the responsibility of the Safety Officer. To mitigate the increased risk profile across the City (Initiative 11.3) and to enhance safety of personnel on scene, a new role of Firefighter Safety/Accountability Officer is required.

Objective #11 Resourcing Community Growth Demands, was initiated to identify resource gaps needed to mitigate increased risk (Initiative #11.3). As a composite response area, Upper Stoney Creek, like Waterdown, has challenges and an increased risk profile in converging an Effective Firefighting & Rescue Force, (EFRF) response as a result of location/geography, volunteer staffing response levels, growth and out-of-area support to volunteer responses. To mitigate risk, a five-person day crew is required, at both Station 17, (Upper Stoney Creek) & Station 24, (Waterdown).

DESCRIPTION

Day Crew - Upper Stoney Creek - 5 FTE

Day Crew - Waterdown - 5 FTE

Continue transition of composite delivery model by increasing full-time firefighting staff at Station 17 (Upper Stoney Creek) and Station 24 (Waterdown) to support Effective Firefighting and Rescue Force (EFRF) through implementation of 5 - person Monday to Friday day crew (5 FTE per Station).

Fire Safety and Accountability Officer - 4 FTE

This position will be responsible to ensure personnel are accounted for on a scene which will enable the Officer to focus on the safety of personnel. To continue to build the multi-functionality of the workforce, this position will also include working with the Safety/Shift Training Officer during their shift to jointly manage and deliver training.

CITY OF HAMILTON

2020 OPERATING BUDGET COUNCIL REFERRED ITEMS

COUNCIL REFERRED ITEM #CR-04

OVERVIEW	
Request Title	Enhancement for CANUSA Funding
Department	Healthy and Safe Communities
Division	Recreation
Service	Recreation Facilities, Products and Services
Proposed Start Date	January - 2020
Strategic Plan Priorities	Economic Prosperity and Growth

2020 OPERATING BUDGET FINANCIAL IMPACTS		
DESCRIPTION	2020 AMOUNT	ANNUALIZED AMOUNT
Total Expenditures	\$10,920	\$10,920
Total Revenue	\$0	\$0
Net Levy	\$10,920	\$10,920
Full Time Equivalent (FTE)	0.0	0.0
Capital Budget Impact	\$0	\$0

COUNCIL REFERRED ITEM #CR-04

BACKGROUND

The Executive Committee for CANUSA Hamilton requested annual static funding from the City of Hamilton to support the planning and implementation of the CANUSA Games. Prior to 2015, CANUSA was not required to make a formal application, but rather, received annual operating funds from the City of Hamilton.

As per Audit, Finance and Administration Report 19-015 Council approved \$30,284 transfer from the City Enrichment Fund to the operating budget of Recreation. CANUSA requires an additional \$10,916 to support their annual operating budget, for a total of \$41,200.

DESCRIPTION

That an enhancement of \$10,916, to increase the annual base budget of funding to CANUSA Hamilton (from \$30,284 to \$41,200) to support the annual CANUSA games at the current level, be submitted through the Recreation Divisions 2020 operating budget for consideration, as per AF&A Report 19-015 Item 6(b).

CITY OF HAMILTON

2020 OPERATING BUDGET COUNCIL REFERRED ITEMS

COUNCIL REFERRED ITEM #CR-05

OVERVIEW	
Request Title	Sidewalk Clearing Program
Department	Public Works - Tax
Division	Transportation Operations & Maintenance
Service	Roadway Access
Proposed Start Date	January - 2020
Strategic Plan Priorities	Economic Prosperity and Growth

2020 OPERATING BUDGET FINANCIAL IMPACTS		
DESCRIPTION	2020 AMOUNT	ANNUALIZED AMOUNT
Total Expenditures	\$0	\$0
Total Revenue	\$0	\$0
Net Levy	TBD	TBD
Full Time Equivalent (FTE)	TBD	TBD
Capital Budget Impact	\$0	\$0

COUNCIL REFERRED ITEM #CR-05

BACKGROUND

Report PW19022(a) will be presented to the General Issues Committee during the Public Works budget presentation in January 2020.

DESCRIPTION

At the March 27, 2019 Council Meeting, staff was directed to prepare a report for consideration during the 2020 budget that would include, but not be limited to, integrating an Equity, Diversity and Inclusion framework of removing snow on sidewalks in high pedestrian areas, around parks, daycare and childcare facilities, senior housing and eldercare facilities and provide connectivity to transit routes.

CITY OF HAMILTON

2020 OPERATING BUDGET COUNCIL REFERRED ITEMS

COUNCIL REFERRED ITEM #CR-06

OVERVIEW	
Request Title	Snow Angels Program (Council Referred Item)
Department	Public Works - Tax
Division	Transportation Operations & Maintenance
Service	Roadway Access
Proposed Start Date	January - 2020
Strategic Plan Priorities	Economic Prosperity and Growth

2020 OPERATING BUDGET FINANCIAL IMPACTS		
DESCRIPTION	2020 AMOUNT	ANNUALIZED AMOUNT
Total Expenditures	\$0	\$0
Total Revenue	\$0	\$0
Net Levy	TBD	TBD
Full Time Equivalent (FTE)	TBD	TBD
Capital Budget Impact	\$0	\$0

COUNCIL REFERRED ITEM #CR-06

BACKGROUND

Report PW19022(a) will be presented to the General Issues Committee during the Public Works budget presentation in January 2020.

DESCRIPTION

At the March 27, 2019 Council Meeting, staff was directed to report either before or to the General Issues Committee during the 2020 Operating Budget process respecting the following: (a) The feasibility of ways and means to enhance the Snow Angel program; (b) The feasibility of greater proactive sidewalk snow removal enforcement; and (c) Communications with Canada Post for regular maintenance (snow and ice removal) of the Community Mailbox locations.

CITY OF HAMILTON

2020 OPERATING BUDGET COUNCIL REFERRED ITEMS

COUNCIL REFERRED ITEM #CR-07

OVERVIEW	
Request Title	City Enrichment Fund
Department	City Manager
Division	Strategic Partnerships & Communications
Service	City Enrichment Fund
Proposed Start Date	January - 2020
Strategic Plan Priorities	Community Engagement and Participation

2020 OPERATING BUDGET FINANCIAL IMPACTS		
DESCRIPTION	2020 AMOUNT	ANNUALIZED AMOUNT
Total Expenditures	\$2,730	\$2,730
Total Revenue	\$0	\$0
Net Levy	\$2,730	\$2,730
Full Time Equivalent (FTE)	0.0	0.0
Capital Budget Impact	\$0	\$0

COUNCIL REFERRED ITEM #CR-07

BACKGROUND

Motion 7.4 presented at Council October 9, 2019

- (a) That an enhancement of an additional \$1,178 for the Concession Street BIA-Sidewalk Sounds base budget be referred to the 2020 Operating Budget Process (GIC) for consideration;
- (b) That an enhancement of an additional \$1,550 for the Concession Street BIA - Street fest base budget, be referred to the 2020 Operating Budget process (GIC) for consideration

DESCRIPTION

City Enrichment Fund 2020 Budget enhancement for Concession Street BIA

CITY OF HAMILTON

2020 OPERATING BUDGET COUNCIL REFERRED ITEMS

COUNCIL REFERRED ITEM #CR-08

OVERVIEW	
Request Title	Implement Living Wage Over Three Year Period
Department	City Manager
Division	Human Resources
Service	Human Resources
Proposed Start Date	January - 2020
Strategic Plan Priorities	Economic Prosperity and Growth

2020 OPERATING BUDGET FINANCIAL IMPACTS		
DESCRIPTION	2020 AMOUNT	ANNUALIZED AMOUNT
Total Expenditures	\$490,000	\$490,000
Total Revenue	\$0	\$0
Net Levy	\$490,000	\$490,000
Full Time Equivalent (FTE)	0.0	0.0
Capital Budget Impact	\$0	\$0

COUNCIL REFERRED ITEM #CR-08

BACKGROUND

On March 27, 2019, Council directed that, per 2019 Operating Budget Report 19-002 Item (g), that staff report back on the impact of implementing a Living Wage Policy for students for 2020 and the rest of the eligible positions over a three year period.

In March 2019, Council requested that staff provide a report outlining the cost of providing a living wage to employees who are paid below the living wage level of \$15.85 per hour. As part of the 2019 budget process, Council approved the provision of the living wage for School Crossing Guards but deferred the decision related to the rest of the positions to the 2020 budget cycle.

DESCRIPTION

Implement Living Wage Policy by setting the wage @ \$15.85 per hour for students in 2020 and for the rest of the eligible positions over a three year period. The total estimate of \$844K comprises of:

- \$313K for students in 2020; and,
- \$177K per annum for each of the years 2020 to 2022 for a total of 531K (including \$209K over the three year period for Library).

CITY OF HAMILTON

2020 OPERATING BUDGET COUNCIL REFERRED ITEMS

COUNCIL REFERRED ITEM #CR-09

OVERVIEW	
Request Title	Establish Climate Change Reserve for Sustainable Funding
Department	Corporate Services
Division	Financial Planning, Admin & Policy
Service	Financial Management
Proposed Start Date	January - 2020
Strategic Plan Priorities	Our People and Performance

2020 OPERATING BUDGET FINANCIAL IMPACTS		
DESCRIPTION	2020 AMOUNT	ANNUALIZED AMOUNT
Total Expenditures	TBD	\$0
Total Revenue	\$0	\$0
Net Levy	TBD	\$0
Full Time Equivalent (FTE)	0.0	0.0
Capital Budget Impact	\$0	\$0

COUNCIL REFERRED ITEM #CR-09

BACKGROUND

On August 15, 2019, the Audit, Finance and Administration Committee reference 19-011 Item 3(c) directed the establishment of a Climate Change Reserve # 108062 for which the funding level was to be determined as part of the 2020 Budget process.

DESCRIPTION

Sustainable funding for the new Climate Change Reserve # 108062 would require an increase to the tax levy.

APPENDIX 7

**2020
Preliminary
Tax Supported
Operating Budget
Business Cases**

BUSINESS CASES SUMMARY

FORM #	DIVISION	SERVICE / PROGRAM	DESCRIPTION OF BUSINESS CASE	2020 IMPACT		FTE Impact
				\$ GROSS	\$ NET	
PLANNING & ECONOMIC DEVELOPMENT						
BC-01	Economic Development	Real Property Management	Converting Contract Positions to Permanent - Real Estate	\$ 323,620	\$ -	3.00
BC-02	Licensing & By-Law Services	By-law Enforcement	Graffiti Management	\$ 252,000	\$ 252,000	3.50
BC-03	Licensing & By-Law Services	Animal Services	Animal Adoption Program Co-ordinator	\$ 90,000	\$ -	1.00
BC-04	Transportation, Planning and Parking	Transportation Planning	Transportation Development Review	\$ -	\$ -	1.00
PLANNING & ECONOMIC DEVELOPMENT SUBTOTAL				\$ 665,620	\$ 252,000	8.50
HEALTHY AND SAFE COMMUNITIES						
BC-05	Hamilton Paramedic Service	Hamilton Paramedic Service	Hamilton Paramedic Service 2020-2023 Enhancement (Ambulance)	\$ 1,039,500	\$ 1,039,500	10.00
HEALTHY AND SAFE COMMUNITIES SUBTOTAL				\$ 1,039,500	\$ 1,039,500	10.00
PUBLIC WORKS - TAX						
BC-06	Transportation Operations & Maintenance	Roadway Access	Converting Consultant Inspectors to In-house Permanent Technologist Inspector & Student Inspectors	\$ 284,270	\$ (89,530)	4.40
BC-07	Energy Fleet and Facilities	Facilities Management	Assistant Stadium Technicians Required for Tim Horton's Field to handle the addition of Forge FC Soccer games.	\$ 140,000	\$ -	2.30
PUBLIC WORKS - TAX SUBTOTAL				\$ 424,270	\$ (89,530)	6.70

BUSINESS CASES SUMMARY

FORM #	DIVISION	SERVICE / PROGRAM	DESCRIPTION OF BUSINESS CASE	2020 IMPACT		FTE Impact
				\$ GROSS	\$ NET	
CITY MANAGER						
BC-08	Human Resources	Human Resources	Return to Work Services Specialist - HR Employee Health and Labour Relations FTE request being funded by Fire	\$ -	\$ -	1.00
CITY MANAGER SUBTOTAL				\$ -	\$ -	1.00
CORPORATE SERVICES						
BC-09	Financial Services	Financial Management	Enhanced WSIB Payroll Processing Services	\$ -	\$ -	1.00
BC-10	Information Technology	Information Technology	Additional FTE for IT Division	\$ -	\$ -	1.00
CORPORATE SERVICES SUBTOTAL				\$ -	\$ -	2.00
TOTAL				\$ 2,129,390	\$ 1,201,970	28.20

CITY OF HAMILTON
2020 OPERATING BUDGET BUSINESS CASES

BUSINESS CASE #BC-01

BUSINESS CASE OVERVIEW	
Request Title	Converting Contract Positions to Permanent - Real Estate
Department	Planning & Economic Development
Division	Economic Development
Service	Real Property Management
Proposed Start Date	January - 2020
Strategic Plan Priorities	Economic Prosperity and Growth

2020 OPERATING BUDGET FINANCIAL IMPACTS		
DESCRIPTION	2020 AMOUNT	ANNUALIZED AMOUNT
Total Expenditures	\$323,620	\$323,620
Total Revenue	\$323,620	\$323,620
Net Levy	\$0	\$0
Full Time Equivalent (FTE)	3.0	3.0
Capital Budget Impact	\$0	\$0

BUSINESS CASE #BC-01**BACKGROUND**

The corporate real estate function has responsibility for the City's real estate assets and portfolio activities, including property acquisitions and divestitures, leasing, property valuation, cash-in-lieu of parkland determination, expropriations, and project leadership for major project implementation.

While achieving many milestones, these positions provide critical support to several priority City initiatives, and the requirement for this resource is important to sustain in the long-run.

Faced with growing pressures on demand for real estate services, and lacking key expertise, Real Estate has created a number of temporary positions since 2016. Due to the temporary nature of the position, the relative pay rate at the City, and the relatively small pool of qualified individuals, Real Estate has had considerable difficulty in filling these positions and maintaining adequate staffing levels. As a result, workload issues continue to be one of the Our People Survey matters.

DESCRIPTION

Convert from temporary to permanent 2 Business Development Consultant – Real Estate positions and 1 Sr. Property Officer/Appraiser position, to support demonstrated on-going workload requirements

CITY OF HAMILTON
2020 OPERATING BUDGET BUSINESS CASES

BUSINESS CASE #BC-02

BUSINESS CASE OVERVIEW	
Request Title	Graffiti Management
Department	Planning & Economic Development
Division	Licensing & By-Law Services
Service	By-law Enforcement
Proposed Start Date	January - 2020
Strategic Plan Priorities	Healthy and Safe Communities

2020 OPERATING BUDGET FINANCIAL IMPACTS		
DESCRIPTION	2020 AMOUNT	ANNUALIZED AMOUNT
Total Expenditures	\$252,000	\$252,000
Total Revenue	\$0	\$0
Net Levy	\$252,000	\$252,000
Full Time Equivalent (FTE)	3.5	3.5
Capital Budget Impact	\$0	\$0

BUSINESS CASE #BC-02

BACKGROUND

PW17078/PED 17198 Council approved a 2 year pilot program for establishing an internal Graffiti Working Group led by Policy and Program staff, to develop and implement a Graffiti Management Strategy with Victim Assistance Program. This included the hiring of 2 FTE Municipal Enforcement officers (co op students)funded through Tax Stabilization Reserve. The pilot program concludes at the end of 2019.

Graffiti impacts the entire community, targeting City and public assets. The 2 year pilot project had a positive response, minimizing reoccurrences and increasing community confidence. The Program Administrator coordinates the removal of graffiti from City and third-party assets, public education and graffiti prevention initiatives identified by the Graffiti Working Group. The 2 student MLEO prevent/respond to new or repeat incidents of graffiti.

DESCRIPTION

To add 1FTE Program Administrator to coordinate the internal Graffiti Working Group.
Add 2 FTE Municipal Law Enforcement Officers (co-op students) and ancillary costs .
Add 0.5 FTE Administrative staff.

Alternatives:

1. Close the program, each Division to address Graffiti issues in their own department
2. Fund the Pro-active student program and \$2,000 per year Victim Assistance Fund to continue the work of Graffiti removal within the City.

CITY OF HAMILTON
2020 OPERATING BUDGET BUSINESS CASES

BUSINESS CASE #BC-03

BUSINESS CASE OVERVIEW	
Request Title	Animal Adoption Program Co-ordinator
Department	Planning & Economic Development
Division	Licensing & By-Law Services
Service	Animal Services
Proposed Start Date	January - 2020
Strategic Plan Priorities	Healthy and Safe Communities

2020 OPERATING BUDGET FINANCIAL IMPACTS		
DESCRIPTION	2020 AMOUNT	ANNUALIZED AMOUNT
Total Expenditures	\$90,000	\$90,000
Total Revenue	\$90,000	\$90,000
Net Levy	\$0	\$0
Full Time Equivalent (FTE)	1.0	1.0
Capital Budget Impact	\$0	\$0

BUSINESS CASE #BC-03**BACKGROUND**

On February 28, 2018, Council approved Item 11 of Planning Committee Report 18-003 directing staff to commence an 18-month Animal Adoption Pilot Program to assess the impacts the program would have on current operations and the City's rescue partners.

Additional FTE required to manage & co-ordinate the Program at an est. cost of \$90K. The Program received \$103,048 in new revenue through collection of adoption fees over the 18-month pilot period. With a Permanent program, \$90K anticipated annually, offsetting budget impacts.

DESCRIPTION

Staff are recommending that animal adoptions be a permanent program within HAS with the addition of an Animal Adoption Program Co-ordinator, fully funded through Animal Adoption Program Revenue.

That one FTE, Animal Adoption Co-ordinator, be approved and funded from the Animal Adoption Revenue for \$90,000 and be referred to the 2020 Budget Deliberation process.

CITY OF HAMILTON
2020 OPERATING BUDGET BUSINESS CASES

BUSINESS CASE #BC-04

BUSINESS CASE OVERVIEW	
Request Title	Transportation Development Review
Department	Planning & Economic Development
Division	Transportation, Planning and Parking
Service	Transportation Planning
Proposed Start Date	January - 2020
Strategic Plan Priorities	Economic Prosperity and Growth

2020 OPERATING BUDGET FINANCIAL IMPACTS		
DESCRIPTION	2020 AMOUNT	ANNUALIZED AMOUNT
Total Expenditures	\$0	\$0
Total Revenue	\$0	\$0
Net Levy	\$0	\$0
Full Time Equivalent (FTE)	1.0	1.0
Capital Budget Impact	\$0	\$0

BUSINESS CASE #BC-04**BACKGROUND**

The 2019 Proposed Tariff of Fees for Planning and Engineering Development Applications (City Wide) (PED19015(a)) included a comprehensive review of user fees. This position will be funded by user fees.

This position is for development reviews completed by the Transportation Planning Section. Transportation Planning's capacity to complete development reviews is critical to meet targeted service levels for development applications.

DESCRIPTION

The purpose of this Business Case is to convert a currently funded temporary position to full time permanent. The position is for development approvals and funded through development application fees.

CITY OF HAMILTON 2020 OPERATING BUDGET BUSINESS CASES

BUSINESS CASE #BC-05

BUSINESS CASE OVERVIEW	
Request Title	Hamilton Paramedic Service 2020-2023 Enhancement (Ambulance)
Department	Healthy and Safe Communities
Division	Hamilton Paramedic Service
Service	Hamilton Paramedic Service
Proposed Start Date	January - 2020
Strategic Plan Priorities	Healthy and Safe Communities

2020 OPERATING BUDGET FINANCIAL IMPACTS		
DESCRIPTION	2020 AMOUNT	ANNUALIZED AMOUNT
Total Expenditures	\$1,039,500	\$1,386,000
Total Revenue	\$0	\$0
Net Levy	\$1,039,500	\$1,386,000
Full Time Equivalent (FTE)	10.0	10.0
Capital Budget Impact	\$270,000	\$270,000

BUSINESS CASE #BC-05**BACKGROUND**

As identified in the Paramedic Service 2017 and 2018 Annual Reports (HSC18020, HSC19035), the Service continues to experience service demand growth at a rate greater than overall population growth. For the past 7 years demand has increased by an average of more than 4% 9-1-1 events annually. This growth is accelerating, with the major increases occurring in seniors (over age 65). Demand is expected to grow at an accelerating rate, with minimal projection of an average of around 3,000 events, and almost 4,000 ambulance responses to these events per year from 2019 - 2023. This translates into an average increase of 12 more ambulance responses per day in each of the next four years, thus necessitating this capability enhancement.

DESCRIPTION

Therefore we are requesting one additional ambulance with ancillary equipment and 10 additional FTE's to provide emergency response 24 hours per day, 7 days per week. Note that Provincial funding will be available for approximately 50 percent of the operating expenses in Year 2 (2021) for these additional expenditures, under current Provincial funding methodologies. There is also \$243,000 of DC's to fund the Capital Purchase of the new vehicle.

CITY OF HAMILTON
2020 OPERATING BUDGET BUSINESS CASES

BUSINESS CASE #BC-06

BUSINESS CASE OVERVIEW	
Request Title	Converting Consultant Inspectors to In-house Permanent Technologist Inspector & Student Inspectors
Department	Public Works - Tax
Division	Transportation Operations & Maintenance
Service	Roadway Access
Proposed Start Date	January - 2020
Strategic Plan Priorities	Economic Prosperity and Growth

2020 OPERATING BUDGET FINANCIAL IMPACTS		
DESCRIPTION	2020 AMOUNT	ANNUALIZED AMOUNT
Total Expenditures	\$284,270	\$284,270
Total Revenue	\$373,800	\$373,800
Net Levy	-\$89,530	-\$89,530
Full Time Equivalent (FTE)	4.4	4.4
Capital Budget Impact	\$0	\$0

BUSINESS CASE #BC-06**BACKGROUND**

The Roads Administration manages 18 regular programs, valued at approximately \$18.9 million. These programs require continuous inspection. A green belt project was conducted to review the current spending on external consultants to inspect projects. The review was also to identify where there is a gap on inspection and if there is potential for cost and efficiency savings by completing the inspection in-house.

The results recommend to bring the process in house. The additional FTE's will provide the program with resources to ensure contracts are delivered and inspected within the City of Hamilton in an efficient and cost-effective manner. By not providing sufficient staffing for inspections, we are putting the City at risk by not maintaining our infrastructure to its life expectancy, creating risk to citizens living or visiting our City by not ensuring the work is completed by the contractor.

DESCRIPTION

The results recommend to bring the process in house and create 1 FTE, Technologist Inspector position, and 3.4 FTE's for student co-op Inspector positions. The costs of the new 4.4 FTE's will be offset by reducing Consultant costs with an estimated 2020 operating budget savings of \$89K.

CITY OF HAMILTON
2020 OPERATING BUDGET BUSINESS CASES

BUSINESS CASE #BC-07

BUSINESS CASE OVERVIEW	
Request Title	Assistant Stadium Technicians Required for Tim Horton's Field to handle the addition of Forge FC Soccer games.
Department	Public Works - Tax
Division	Energy Fleet and Facilities
Service	Facilities Management
Proposed Start Date	January - 2020
Strategic Plan Priorities	Clean and Green

2020 OPERATING BUDGET FINANCIAL IMPACTS		
DESCRIPTION	2020 AMOUNT	ANNUALIZED AMOUNT
Total Expenditures	\$140,000	\$140,000
Total Revenue	\$140,000	\$140,000
Net Levy	\$0	\$0
Full Time Equivalent (FTE)	2.3	2.3
Capital Budget Impact	\$0	\$0

BUSINESS CASE #BC-07**BACKGROUND**

With the addition of the Canadian Soccer League and with Community and user group events, Tim Hortons Field has seen an increase in revenues and higher demand for quality service resulting in the need for additional FTEs. The additional FTEs, will provide operational support for one of the City of Hamilton's largest assets, assist in delivering the program schedule and will have a net zero impact to the operating budget, based on revenues from the Soccer Agreement.

Without the additional FTEs, City staff may be required to either refuse events due to insufficient staffing budget or convert an existing Facilities position, reducing services elsewhere.

DESCRIPTION

New revenue stream requires additional support of 2.3 part-time FTEs in the position of Assistant Stadium Technician, to handle the addition of Forge FC Soccer games. For the City of Hamilton to provide quality service and continue to increase revenue and interest at Tim Hortons Field, a minimum of 2.3 FTE is required to keep up with demand.

CITY OF HAMILTON
2020 OPERATING BUDGET BUSINESS CASES

BUSINESS CASE #BC-08

BUSINESS CASE OVERVIEW	
Request Title	Return to Work Services Specialist - HR Employee Health and Labour Relations FTE request being funded by Fire
Department	City Manager
Division	Human Resources
Service	Human Resources
Proposed Start Date	January - 2020
Strategic Plan Priorities	Our People and Performance

2020 OPERATING BUDGET FINANCIAL IMPACTS		
DESCRIPTION	2020 AMOUNT	ANNUALIZED AMOUNT
Total Expenditures	\$0	\$0
Total Revenue	\$0	\$0
Net Levy	\$0	\$0
Full Time Equivalent (FTE)	1.0	1.0
Capital Budget Impact	\$0	\$0

BUSINESS CASE #BC-08**BACKGROUND**

In a report on attendance presented to the Audit, Finance and Administration Committee in April 2017, an action plan was developed to address the rise in absenteeism in the Fire Department in 2015 and 2016 (HUR 17010). The plan included an 18-month pilot with a dedicated full time Return to Work Services Specialist. Since 2017 a full-time Return to Work Services Specialist has been assigned to work with Fire management.

This position will be funded exclusively by the Fire Department and with a permanent dedicated assignment. This request comes as a result of a successful 18-month trial that has provided evidence worthy of its continuance on a permanent basis. The Return to Work Specialist will continue with all of the efforts developed over the past 18 months in maintaining a supportive and guided approach to disability management that emphasized regular and predictable attendance at work.

DESCRIPTION

That Council approve one (1) Permanent Full Time Return to Work Services Specialist for dedicated assignment to the Fire Department. The FTE position will be part of Human Resources staff complement (in Return to Work Services) with ongoing funding provided by Fire.

CITY OF HAMILTON
2020 OPERATING BUDGET BUSINESS CASES

BUSINESS CASE #BC-09

BUSINESS CASE OVERVIEW	
Request Title	Enhanced WSIB Payroll Processing Services
Department	Corporate Services
Division	Financial Services
Service	Financial Management
Proposed Start Date	January - 2020
Strategic Plan Priorities	Our People and Performance

2020 OPERATING BUDGET FINANCIAL IMPACTS		
DESCRIPTION	2020 AMOUNT	ANNUALIZED AMOUNT
Total Expenditures	\$0	\$0
Total Revenue	\$0	\$0
Net Levy	\$0	\$0
Full Time Equivalent (FTE)	1.0	1.0
Capital Budget Impact	\$0	\$0

BUSINESS CASE #BC-09**BACKGROUND**

Police: Approved by Police Services Board in Dec 2017 per PSP 17-137

Fire: Memorandum of Agreement dated March 15 2019

Savings will accrue in City Divisions with staff on WSIB

DESCRIPTION

Alter WSIB payment method by paying the lower WSIB non taxable award directly to employee plus WSIB top-up to maintain the pre-disability net pay. This change would result in annual savings of \$40K PER ABSENCE; and, CPP refund claims previously forgone will be filed.

Arrangement already in place for Fire and Police; this proposal is to extend this to rest of the City.

CITY OF HAMILTON
2020 OPERATING BUDGET BUSINESS CASES

BUSINESS CASE #BC-10

BUSINESS CASE OVERVIEW	
Request Title	Additional FTE for IT Division
Department	Corporate Services
Division	Information Technology
Service	Information Technology
Proposed Start Date	January - 2020
Strategic Plan Priorities	Community Engagement and Participation

2020 OPERATING BUDGET FINANCIAL IMPACTS		
DESCRIPTION	2020 AMOUNT	ANNUALIZED AMOUNT
Total Expenditures	\$0	\$0
Total Revenue	\$0	\$0
Net Levy	\$0	\$0
Full Time Equivalent (FTE)	1.0	1.0
Capital Budget Impact	\$0	\$0

BUSINESS CASE #BC-10**BACKGROUND**

The FTE will be used to make a resource that has been employed on a temporary basis since 2015 permanent. This resource has specific subject matter expertise required to deliver key strategic initiatives for the Planning & Economic Development department. The FTE will be fully funded by the Planning & Economic Development department. The FTE has the skillset and subject matter expertise to deliver the expansion of the Amanda software application within Planning & Economic Development, a key strategic initiative for the department. This proposal is supported by the PED leadership team.

This FTE will be leveraged to create a permanent position for a position that has been temporary since 2015.

DESCRIPTION

This FTE will be leveraged to provide additional support for the PED AMANDA team and will work on key strategic initiatives including the Amanda software expansion project.

APPENDIX 8

**2020
Preliminary
Tax Supported
Operating Budget
Multi-Year
Budget Outlook**

MULTI-YEAR OUTLOOK

Multi-Year Outlook								
2021			2022			2023		
\$	2021 vs 2020	%	\$	2022 vs 2021	%	\$	2023 vs 2022	%

PLANNING & ECONOMIC DEVELOPMENT

General Manager	1,079,230	41,140	4.0%	1,104,000	24,770	2.3%	1,142,120	38,120	3.5%
Transportation, Planning and Parking Building	2,518,570	74,860	3.1%	2,424,290	(94,280)	(3.7%)	2,350,000	(74,290)	(3.1%)
Economic Development	1,188,190	127,500	12.0%	1,181,630	(6,560)	(0.6%)	1,207,150	25,520	2.2%
Growth Management	5,534,510	113,040	2.1%	5,633,660	99,150	1.8%	5,727,200	93,540	1.7%
Licensing & By-Law Services	776,120	185,300	31.4%	534,550	(241,570)	(31.1%)	677,590	143,040	26.8%
Planning	6,812,640	166,690	2.5%	6,953,200	140,560	2.1%	7,076,280	123,080	1.8%
Tourism & Culture	4,406,920	664,650	17.8%	4,311,570	(95,350)	(2.2%)	4,490,470	178,900	4.1%
	9,399,050	179,510	1.9%	9,563,990	164,940	1.8%	9,716,030	152,040	1.6%
TOTAL PLANNING & ECONOMIC DEVELOPMENT	31,715,230	1,552,690	5.1%	31,706,890	(8,340)	(0.0%)	32,386,840	679,950	2.1%

HEALTHY AND SAFE COMMUNITIES

HSC Administration	2,889,770	92,950	3.3%	2,965,660	75,890	2.6%	3,032,010	66,350	2.2%
Children's Services and Neighbourhood Dev. Ontario Works	12,621,480	1,639,860	14.9%	12,719,190	97,710	0.8%	12,815,410	96,220	0.8%
Housing Services	13,575,430	532,050	4.1%	14,046,360	470,930	3.5%	14,492,090	445,730	3.2%
Long Term Care	48,336,640	3,056,810	6.8%	50,695,970	2,359,330	4.9%	52,387,890	1,691,920	3.3%
Recreation	15,086,070	1,004,660	7.1%	15,777,760	691,690	4.6%	16,464,590	686,830	4.4%
Hamilton Fire Department	34,966,670	784,870	2.3%	35,518,710	552,040	1.6%	36,044,850	526,140	1.5%
Hamilton Paramedic Service	96,406,810	2,717,100	2.9%	99,106,300	2,699,490	2.8%	101,881,380	2,775,080	2.8%
Public Health Services	26,071,260	962,490	3.8%	26,515,870	444,610	1.7%	27,031,860	515,990	1.9%
	15,581,220	2,108,230	15.6%	16,435,490	854,270	5.5%	17,255,590	820,100	5.0%
TOTAL HEALTHY AND SAFE COMMUNITIES	265,535,350	12,899,020	5.1%	273,781,310	8,245,960	3.1%	281,405,670	7,624,360	2.8%

PUBLIC WORKS

PW-General Administration	921,990	18,450	2.0%	940,800	18,810	2.0%	960,000	19,200	2.0%
Energy Fleet and Facilities	9,540,330	242,970	2.6%	9,636,742	96,412	1.0%	9,721,003	84,261	0.9%
Engineering Services	0	0	0.0%	0	0	0.0%	0	0	0.0%
Environmental Services	85,330,910	2,536,480	3.1%	87,453,710	2,122,800	2.5%	89,598,870	2,145,160	2.5%
Transit	90,102,380	8,706,670	10.7%	96,367,180	6,264,800	7.0%	102,362,490	5,995,310	6.2%
Transportation Operations & Maintenance	83,295,100	1,854,530	2.3%	84,742,720	1,447,620	1.7%	85,928,100	1,185,380	1.4%
TOTAL PUBLIC WORKS	269,190,710	13,359,100	5.2%	279,141,152	9,950,442	3.7%	288,570,463	9,429,311	3.4%

LEGISLATIVE

Legislative General	(362,260)	(2,690)	0.7%	(365,060)	(2,800)	0.8%	(367,860)	(2,800)	0.8%
Mayors Office	1,201,160	37,140	3.2%	1,221,570	20,410	1.7%	1,241,570	20,000	1.6%
Volunteer Committee	112,650	0	0.0%	112,650	0	0.0%	112,650	0	0.0%
Ward Budgets	4,237,720	67,600	1.6%	4,306,220	68,500	1.6%	4,372,770	66,550	1.5%
TOTAL LEGISLATIVE	5,189,270	102,050	2.0%	5,275,380	86,110	1.7%	5,359,130	83,750	1.6%

MULTI-YEAR OUTLOOK

Multi-Year Outlook					
2021		2022		2023	
\$	2021 vs 2020	\$	2022 vs 2021	\$	2023 vs 2022

CITY MANAGER									
Office of the City Auditor	1,178,030	26,320	2.3%	1,199,980	21,950	1.9%	1,221,380	21,400	1.8%
CMO - Admin & Digital Office	438,720	17,710	4.2%	450,020	11,300	2.6%	460,950	10,930	2.4%
Strategic Partnerships & Communications	3,211,620	73,780	2.4%	3,265,090	53,470	1.7%	3,316,100	51,010	1.6%
Human Resources	7,695,450	142,890	1.9%	7,828,750	133,300	1.7%	7,956,000	127,250	1.6%
TOTAL CITY MANAGER	12,523,820	260,700	2.1%	12,743,840	220,020	1.8%	12,954,430	210,590	1.7%

CORPORATE SERVICES									
City Clerk's Office	2,861,520	70,900	2.5%	2,915,200	53,680	1.9%	2,967,860	52,660	1.8%
Corporate Services - Administration	331,240	6,390	2.0%	337,470	6,230	1.9%	343,510	6,040	1.8%
Customer Service	5,646,840	121,870	2.2%	5,757,580	110,740	2.0%	5,866,420	108,840	1.9%
Financial Planning, Admin & Policy	5,096,460	181,970	3.7%	5,250,400	153,940	3.0%	5,399,050	148,650	2.8%
Financial Services	4,346,620	99,820	2.4%	4,458,050	111,430	2.6%	4,566,140	108,090	2.4%
Information Technology	12,727,350	1,223,960	10.6%	13,391,440	664,090	5.2%	14,049,100	657,660	4.9%
Legal Services	3,576,650	160,300	4.7%	3,703,630	126,980	3.6%	3,826,200	122,570	3.3%
TOTAL CORPORATE SERVICES	34,586,680	1,865,210	5.7%	35,813,770	1,227,090	3.5%	37,018,280	1,204,510	3.4%

CORPORATE FINANCIALS - EXPENDITURES									
Non Program Expenditures	25,282,280	1,022,430	4.2%	24,249,360	(1,032,920)	(4.1%)	24,264,950	15,590	0.1%
TOTAL CORPORATE FINANCIALS	25,282,280	1,022,430	4.2%	24,249,360	(1,032,920)	(4.1%)	24,264,950	15,590	0.1%

HAMILTON ENTERTAINMENT FACILITIES									
Operating	4,550,300	49,110	1.1%	4,600,580	50,280	1.1%	4,652,050	51,470	1.1%
TOTAL HAMILTON ENTERTAINMENT FACILITIES	4,550,300	49,110	1.1%	4,600,580	50,280	1.1%	4,652,050	51,470	1.1%

TOTAL CITY EXPENDITURES	648,573,640	31,110,310	5.0%	667,312,282	18,738,642	2.9%	686,611,813	19,299,531	2.9%
--------------------------------	--------------------	-------------------	-------------	--------------------	-------------------	-------------	--------------------	-------------------	-------------

CAPITAL FINANCING									
Debt-Healthy & Safe Communities	2,303,440	(36,280)	(1.6%)	2,266,440	(37,000)	(1.6%)	2,228,700	(37,740)	(1.7%)
Debt-Infrastructure Renewal Levy	13,428,870	0	0.0%	13,428,870	0	0.0%	13,428,870	0	0.0%
Debt-Corporate Financials	90,062,300	6,293,000	7.5%	95,935,300	5,873,000	6.5%	101,306,300	5,371,000	5.6%
Debt-Planning & Economic Development	194,070	0	0.0%	194,070	0	0.0%	194,070	0	0.0%
Debt-Public Works	38,675,500	(20,420)	(0.1%)	38,654,670	(20,830)	(0.1%)	38,633,420	(21,250)	(0.1%)
TOTAL CAPITAL FINANCING	144,664,180	6,236,300	4.5%	150,479,350	5,815,170	4.0%	155,791,360	5,312,010	3.5%

MULTI-YEAR OUTLOOK

Multi-Year Outlook				
2021		2022		2023
\$	2021 vs 2020	\$	2022 vs 2021	2023 vs 2022

BOARDS & AGENCIES

POLICE SERVICES

Operating	175,761,530	5,252,590	3.1%	181,174,786	5,413,256	3.1%	186,753,654	5,578,868	3.1%
Capital Financing	805,750	0	0.0%	805,750	0	0.0%	805,750	0	0.0%
TOTAL POLICE SERVICES	176,567,280	5,252,590	3.1%	181,980,536	5,413,256	3.1%	187,559,404	5,578,868	3.1%

OTHER BOARDS & AGENCIES

Library	32,017,790	688,190	2.2%	32,646,780	628,990	2.0%	33,130,450	483,670	1.5%
Conservation Authorities	8,330,610	151,870	1.9%	8,485,520	154,910	1.9%	8,643,530	158,010	1.9%
Hamilton Beach Rescue Unit	137,030	2,690	2.0%	139,770	2,740	2.0%	142,570	2,800	2.0%
Royal Botanical Gardens	647,410	12,690	2.0%	660,360	12,950	2.0%	673,570	13,210	2.0%
MPAC	6,986,510	136,990	2.0%	7,126,240	139,730	2.0%	7,268,770	142,530	2.0%
Farmers Market	116,760	3,960	3.5%	114,370	(2,390)	(2.0%)	111,610	(2,760)	(2.4%)
TOTAL OTHER BOARDS & AGENCIES	48,236,110	996,390	2.1%	49,173,040	936,930	1.9%	49,970,500	797,460	1.6%

Capital Financing - Other Boards & Agencies

	191,240	0	0.0%	191,240	0	0.0%	191,240	0	0.0%
--	---------	---	------	---------	---	------	---------	---	------

City Enrichment Fund

	6,207,322	121,712	2.0%	6,331,468	124,146	2.0%	6,458,097	126,629	2.0%
--	-----------	---------	------	-----------	---------	------	-----------	---------	------

TOTAL BOARDS & AGENCIES

	231,201,952	6,370,692	2.8%	237,676,284	6,474,332	2.8%	244,179,241	6,502,957	2.7%
TOTAL EXPENDITURES	1,024,439,772	43,717,302	4.5%	1,055,467,916	31,028,144	3.0%	1,086,582,414	31,114,498	2.9%

NON PROGRAM REVENUES

Payment In Lieu	(16,026,300)	0	0.0%	(16,026,300)	0	0.0%	(16,026,300)	0	0.0%
Penalties and Interest	(11,000,000)	0	0.0%	(11,000,000)	0	0.0%	(11,000,000)	0	0.0%
Right of Way	(3,228,000)	0	0.0%	(3,228,000)	0	0.0%	(3,228,000)	0	0.0%
Senior Tax Credit	567,000	0	0.0%	567,000	0	0.0%	567,000	0	0.0%
Supplementary Taxes	(9,425,000)	0	0.0%	(9,425,000)	0	0.0%	(9,425,000)	0	0.0%
Tax Remissions and Write Offs	9,600,000	0	0.0%	9,600,000	0	0.0%	9,600,000	0	0.0%
Hydro Dividend and Other Interest	(4,602,940)	0	0.0%	(4,602,940)	0	0.0%	(4,602,940)	0	0.0%
Investment Income	(4,100,000)	0	0.0%	(4,100,000)	0	0.0%	(4,100,000)	0	0.0%
Slot Revenues	(5,200,000)	0	0.0%	(5,200,000)	0	0.0%	(5,200,000)	0	0.0%
POA Revenues	(2,302,380)	0	0.0%	(2,302,380)	0	0.0%	(2,302,380)	0	0.0%
TOTAL NON PROGRAM REVENUES	(45,717,620)	0	0.0%	(45,717,620)	0	0.0%	(45,717,620)	0	0.0%

TOTAL LEVY REQUIREMENT

	978,722,152	43,717,302	4.7%	1,009,750,296	31,028,144	3.2%	1,040,864,794	31,114,498	3.1%
--	-------------	------------	------	---------------	------------	------	---------------	------------	------

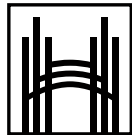

Hamilton

Item 6.1



Hamilton

2020 BUDGET OVERVIEW

GENERAL ISSUES COMMITTEE

Report FCS20001

January 17th, 2020

2020 BUDGET COUNCIL DIRECTION

- User Fees be increased **3%** and staff report back on fees that could be considered to move towards full cost recovery
- Police, Libraries and Conservation Authorities target a guideline of **2%**
- All other boards and agencies target a guideline of **0%**
- Tax Capital budget be submitted at a total levy impact of **1.3%**
- The Rate budget include options to reduce the projected increase of **4.5%**
- Staff develop options to reduce the tax impact based on these scenarios:
 - Reductions of **\$18.3M** to achieve a **4.6%** tax impact
 - Reductions of **\$27.0M** to achieve a **3.6%** tax impact
 - Reductions of **\$35.7M** to achieve a **2.6%** tax impact

2020 OUTLOOK VS CURRENT

2020 Tax Budget	Municipal	Levy Increase \$	Tax Impact %
	Outlook (October)	52,339,000	5.50%
	Preliminary	48,217,460	5.00%
	Current	42,247,460	4.00%
	Total Inclusive with Education		3.50%

PROPOSED BUDGET REDUCTION PRINCIPLES



Financials

- Review 2019 Actuals – Adjust budget based on actuals.



Services

- No service impact.
- Continue to find efficiencies.

2020 BUDGET AMENDMENT ITEMS

			Residential Impact
Preliminary Residential Tax Increase - Budget Book		\$ 48,217,460	5.0%
APPROVED AMENDMENTS:			
Public Works	Minimum vehicle fee inc. - Transfer Stations/CRC (from \$8.50 to \$10)	(100,000)	
Capital Financing	DC Exemptions contribution to be funded one time for 2020	(2,000,000)	
PROPOSED AMENDMENTS:			
Corporate Financials	Partial mitigation of 2020 Operating Impacts of Capital - New Traffic Signals (Decrease of 2.6 FTE)	(327,000)	
Public Works (City Wide)	Fuel Savings as a result of a \$0.02 reduction	(220,000)	
Public Works	Environmental Services - Landfill Contract Efficiencies	(75,000)	
Public Works	Contractual adjustments	(370,000)	
Healthy & Safe Communities	Housing - Financial Adjustments to Benchmarks	(1,000,000)	
Healthy & Safe Communities	OW deliver at 2019 budget levels	(1,100,000)	
Healthy & Safe Communities	Public Health Reserve	(278,000)	
PENDING AMENDMENTS:			
Planning & Economic Development	Parking fines and rates	(500,000)	0.4%
		\$ 42,247,460	4.6%
Updated Assessment Growth Impact (from 1.0% to 1.2%)			(0.2)%
Elimination of tax discount for vacant & excess lands subclass			(0.2)%
AVERAGE RESIDENTIAL MUNICIPAL TAX IMPACT			4.0%
AVERAGE RESIDENTIAL TOTAL TAX IMPACT (INCLUSIVE OF EDUCATION)			3.5%

2020 AVERAGE RESIDENTIAL TAX IMPACT

	2019 \$	2020 \$	Change \$	Change %
City Departments	2,379	2,458	79	2.2%
Boards and Agencies	827	857	30	0.9%
Capital Financing	351	382	31	0.9%
MUNICIPAL TAX IMPACT	3,557	3,698	141	4.0%
Education Taxes	577	581	4	0.7%
TOTAL TAX IMPACT	4,134	4,279	145	3.5%

NOTE: Anomalies due to rounding

**Ward Average Reassessment
Impacts range**



-0.5% to +2.0%

6



2020 NET OPERATING BUDGET BY DEPARTMENT

(\$000's)

	2019 \$	2020 \$	Change 2020 / 2019	
Department	Restated Budget	Preliminary Budget	\$	%
Planning & Economic Development	29,334	29,663	329	1.1%
Healthy and Safe Communities	243,634	250,258	6,625	2.7%
Public Works	242,057	255,091	13,035	5.4%
Legislative	4,971	5,087	116	2.3%
City Manager	11,943	12,263	320	2.7%
Corporate Services	32,282	32,721	439	1.4%
Corp Financials/Non Prog Revenues	(25,397)	(21,809)	3,588	14.1%
Hamilton Entertainment Facilities	3,912	4,501	589	15.0%
Total City Departments	542,736	567,776	25,040	4.6%
Total Boards & Agencies	214,172	223,834	9,663	4.5%
Capital Financing	129,880	137,425	7,545	5.8%
Total Preliminary Operating Budget	886,787	929,035	42,247	4.8%
Total Average Residential Municipal Property Tax Impact				4.0%
Total Average Residential Property Tax Impact Inclusive of Education				3.5%







7

CITY DEPARTMENTS ANALYSIS OF BUDGET

	City Departments	\$ 25.0 M	2.2%
LESS:			
	Provincial Funding	(4.7 M)	(0.5)%
	Transportation (Transit, ATS)	(4.3 M)	(0.5)%
	Operating Impact of Capital	(2.0 M)	(0.2)%
	Total Maintenance Pressure	\$ 14.0 M	1.0%

NOTE: Anomalies due to rounding

BUDGET DRIVERS - MAINTENANCE

	Salaries, Wages & Benefits	\$ 9.3 M
	Insurance Premiums	2.0 M
	WSIB Shortfall	1.5 M
	Road Salt Contract	1.5 M
	Computer Software Licensing	1.5 M
	Other	(1.8 M)
Total		\$ 14.0 M

NOTE: Anomalies due to rounding

BUDGET DRIVERS - ADDITIONAL ITEMS

Provincial Funding



Children's Services

\$ 2.3 M



Public Health

1.4 M



Ontario Works

1.0 M

Total

\$ 4.7 M

Transit



DARTS

\$ 2.7 M



PRESTO

0.9 M



Transit Strategy

0.7 M





Total

\$ 4.3 M¹⁰

NOTE: Anomalies due to rounding

BUDGET DRIVERS - ADDITIONAL ITEMS

Operating Impacts of Capital





	Traffic Management/Signaling	\$ 0.4 M
	Confederation Park	0.3 M
	Backflow Prevention	0.2 M
	IT Strategy	0.2 M
	Other	0.9 M
Total		\$ 2.0 M

TOTAL BUDGET DRIVERS - ADDITIONAL ITEMS \$ 11.0M

NOTE: Anomalies due to rounding

11

CAPITAL FINANCING

	Capital Tax Levy for Block and Discretionary Funding	\$ 4.3 M
	Investing in Canada Infrastructure Program - Transit	1.8 M
	Office Accommodation	1.1 M
	West Harbour Development	0.3 M
Total		\$ 7.5 M

NOTE: Anomalies due to rounding

BOARDS & AGENCIES

2020 NET OPERATING BUDGET (\$000's)

	2020 Budget Impact (\$)	Change (%)
Conservation Authorities	2,681	48.8%
Farmers Market	0	0.0%
Hamilton Beach Rescue Unit	0	0.0%
MPAC	134	2.0%
Royal Botanical Gardens	0	0.0%
Police	6,219	3.8%
Library	629	2.0%
City Enrichment Fund	0	0.0%
Total	9,663	4.5%

2020 STAFFING COMPLEMENT (TAX) (EXCLUSIVE OF BOARDS & AGENCIES)

	Change	Total
2019 Restated		5,837.30
Operating Impacts from Capital	11.60	
Other Complement Change:		
Reduction (HSC)	(42.70)	
Reduction (PED)	(1.00)	
Public Works - Transit	<u>35.00</u>	
Total Other Complement Change	(8.70)	
Total Change		2.90
Total 2020 Complement		5,840.20
Budget Amendments:		
Reduction in Public Works - OIC	<u>(2.60)</u>	
Total 2020 Complement including Budget Amendments		5,837.60

REASSESSMENT TAX SHIFTS

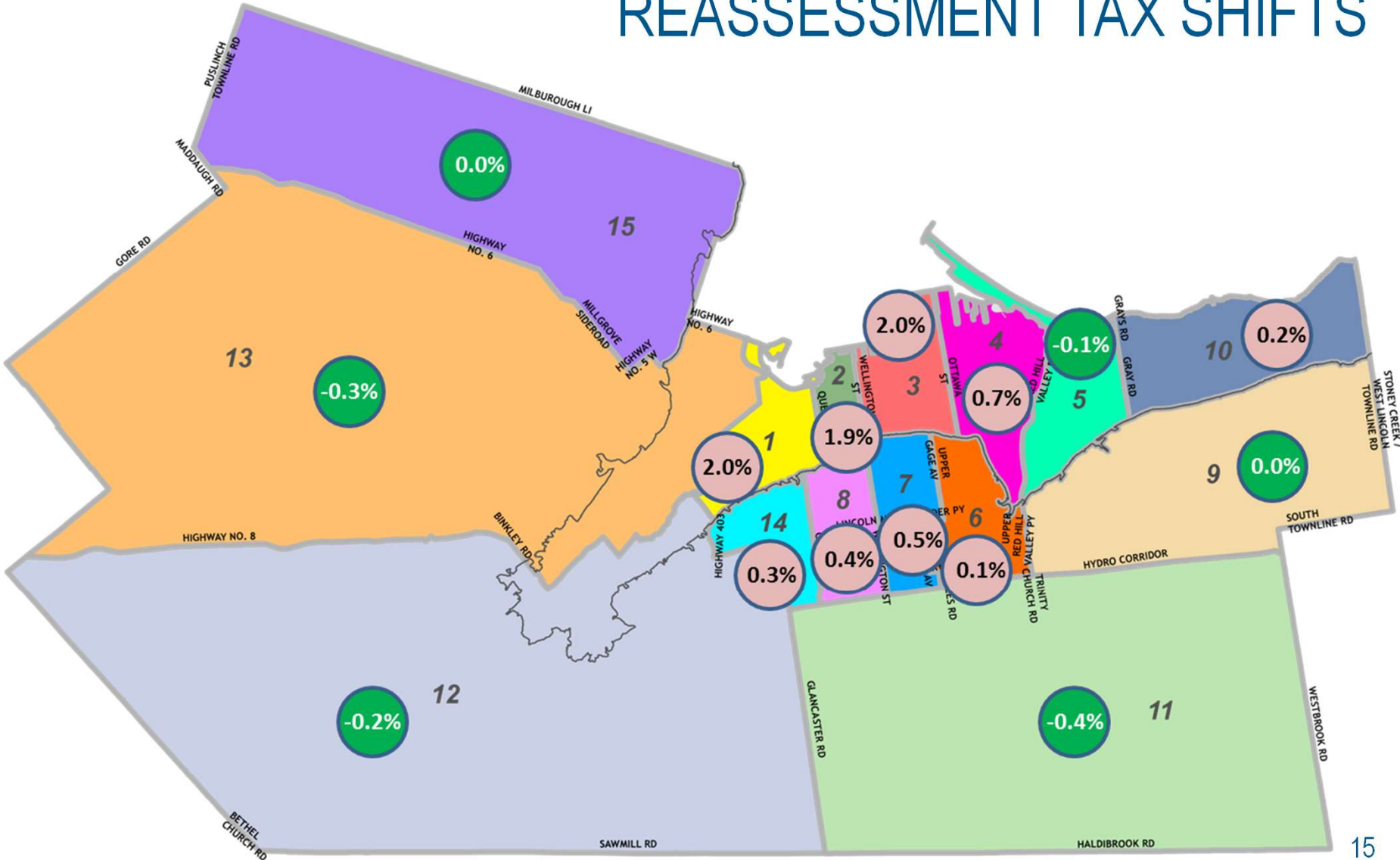

TAX POLICY MATTERS

- Elimination of the tax discount for vacant and excess lands in the Commercial and Industrial property classes results in a class shift benefiting the Residential property class by (0.2%)
- The City continues to be impacted by the levy restriction to the Industrial property class
- Reassessment and full levy restrictions to the Multi-Residential property class will also continue for the 2020 year
- These impacts are already included in estimated municipal tax impact of 4.0%

16

2020 REDUCTION SCENARIOS

	Reduction (\$)	Levy Increase (\$)	Total Residential Tax Incr.
Preliminary Budget		42,247,460	3.5%
Total Reductions Of	(8,500,000)	33,742,456	2.6%

- Excludes potential increases due to 2020 Referred Items and Business Cases
- \$9.4M is required to adjust the municipal tax impact by 1%
- Total Residential Tax Increase includes Education

LIMITED CONTROL

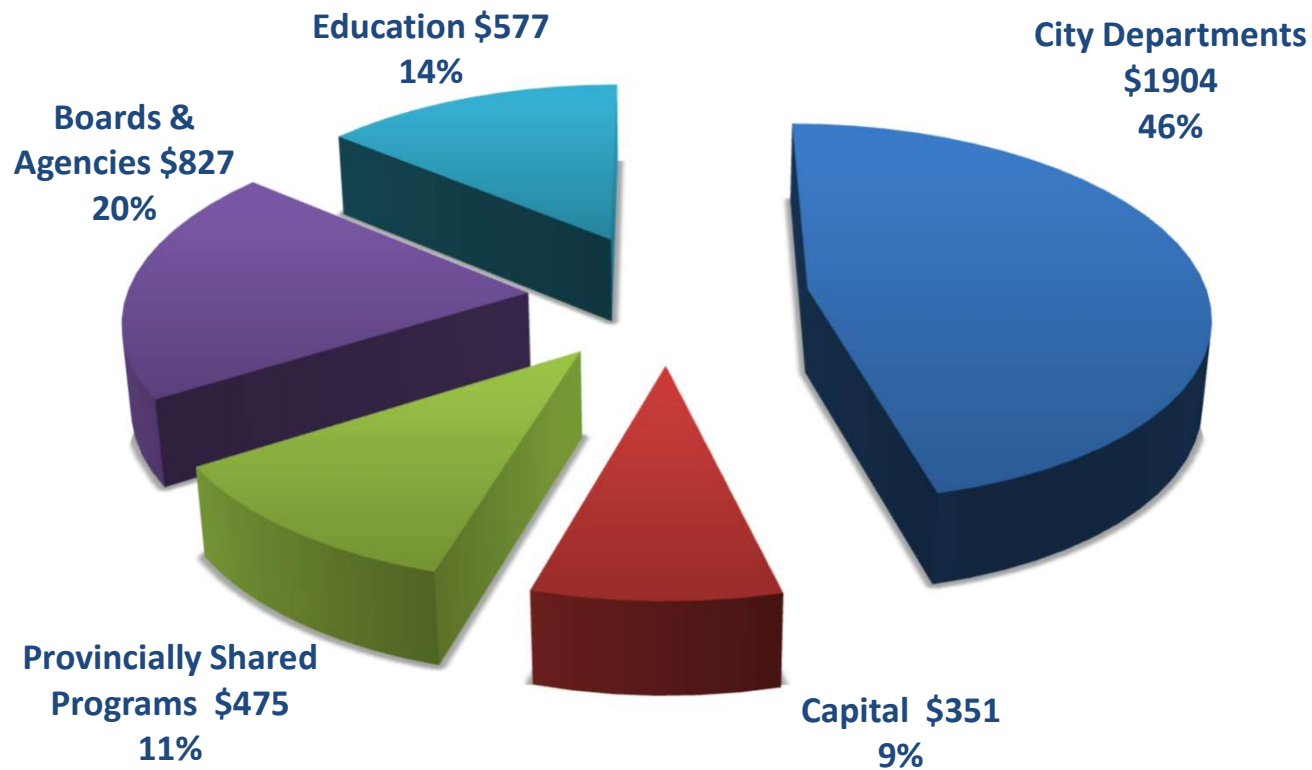

Based on 2019 Budget - Total \$4,134 - Municipal Only \$3,557 (86%)

MITIGATION OPTION TYPES



Financials

- Reduce contributions to reserves impacting long term financial plan.



Revenues

- Enhance user fee increases in many areas. Introduce new fees for service. Reduce or eliminate fee waivers.



Services

- Reduce response time to inquiries, request for service.
- Reduce capability for policy work including in-year requests from Council.
- Reduce service hours for facilities/programs.
- Close under utilized facilities.
- Reduce or eliminate service levels where service is under utilized.
- Align service levels to comparator municipalities where the City exceeds those comparators.
- Align service levels to provincial funding.
- Reduce grants to external agencies.
- Eliminate / Close non-core services / facilities

2020 RESIDENTIAL TAX IMPACTS COMPARATORS

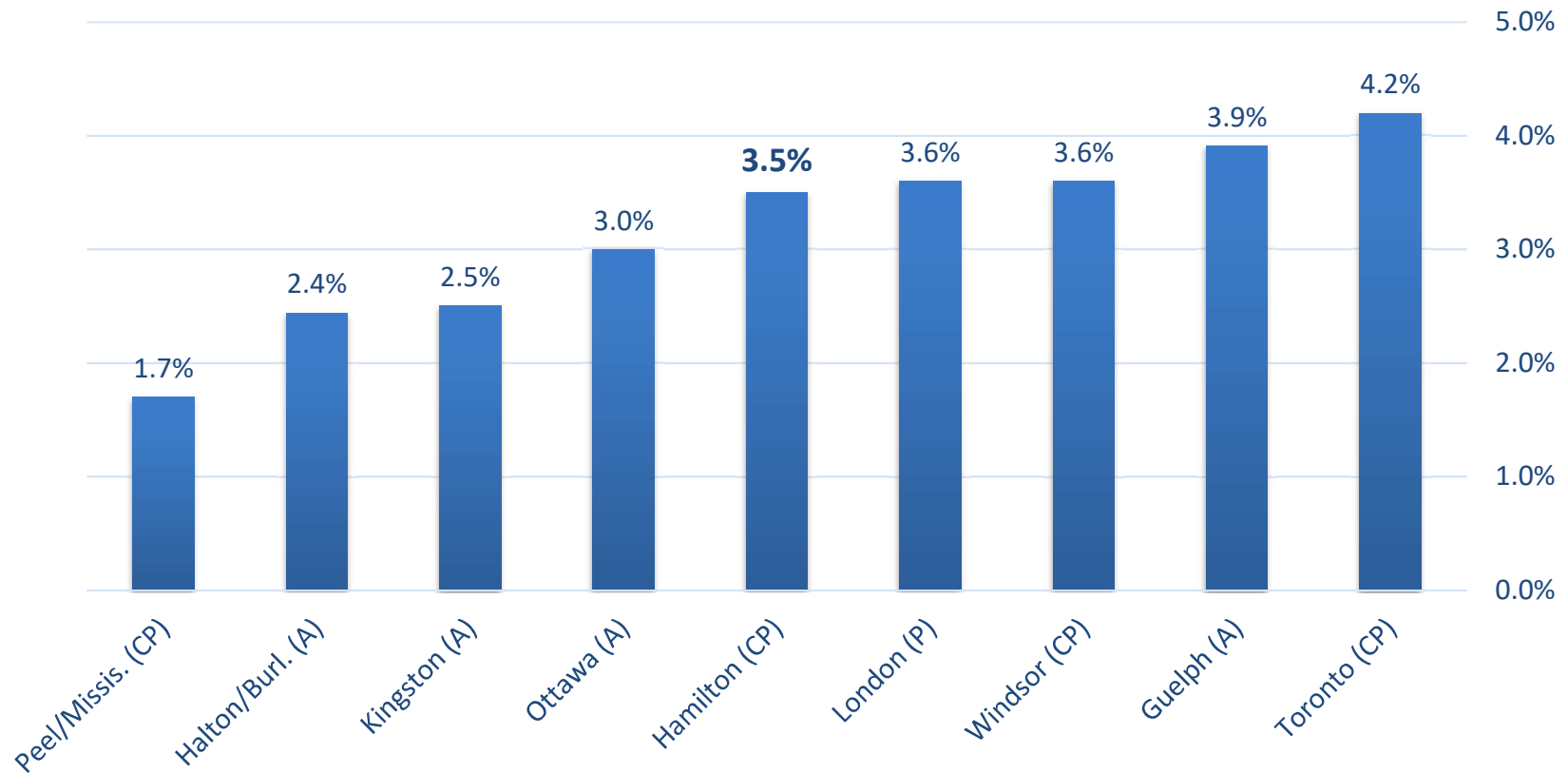

P = Proposed
CP = Current Position
A = Approved

Note: West Lincoln, Haldimand County and Guelph are pending.



2020 COUNCIL REFERRED ITEMS

2020 OPERATING BUDGET

2020 COUNCIL REFERRED ITEMS

- Items previously considered at Council and referred to the budget process for further discussion.

- 13 council referred items:

Department	# of Items	Gross (\$)	Net (\$)	FTE
Planning & Economic Development	3	45,000	45,000	1.5
Healthy and Safe Communities	2	621,340	583,340	14.0
Public Works	3	30,000	30,000	0.0
City Manager	2	492,730	492,730	0.0
Corporate Services	2	160,000	160,000	0.0
Boards and Agencies	1	145,000	145,000	0.0
TOTAL	13	1,494,070	1,456,070	15.5

- Not included in Preliminary Budget. If approved, would result in a 0.2% tax impact.

2020 COUNCIL REFERRED ITEMS

BUDGET BOOK

#	Department	Item	Gross (\$)	Net (\$)	FTE
1	Planning & Economic Development	Cigarette Butt By-law Enforcement Officer	45,000	45,000	0.50
2	Planning & Economic Development	Hess Village Paid Duty Police	TBD	TBD	0.00
3	Healthy and Safe Communities	10 Year Fire Service Delivery Plan	610,420	572,420	14.00
4	Healthy and Safe Communities	Enhancement for CANUSA Games Funding	10,920	10,920	0.00
5	Public Works	Sidewalk Clearing Program	TBD	TBD	TBD
6	Public Works	Snow Angels Program	TBD	TBD	TBD
7	City Manager	City Enrichment Fund	2,730	2,730	0.00
8	City Manager	Implement Living Wage Over Three Year Period	490,000	490,000	0.00
9	Corporate Services	Establish Climate Change Reserve for Sustainable Funding	TBD	TBD	0.00
TOTAL BUDGET BOOK			1,159,070	1,121,070	14.50
Additional Post-Budget Book Items:					
10	Corporate Services	Corporate Goals and Areas of Focus for Climate Change Mitigation and Adaptation	160,000	160,000	0.00
11	Public Works	Ongoing care and maintenance of the Aviary and birds	30,000	30,000	0.00
12	Boards and Agencies	Parkdale Landing Library Mini Branch	145,000	145,000	0.00
13	Planning & Economic Development	Animal Adoption Pilot Program	TBD	0	1.00
Subtotal:			335,000	335,000	1.00
TOTAL COUNCIL REFERRED ITEMS			1,494,070	1,456,070	15.50



2020 BUSINESS CASES

2020 OPERATING BUDGET

2020 BUSINESS CASES

- 10 business cases for consideration in the 2020 budget process:

Department	# of Business Cases Submitted	Gross (\$)	Net (\$)	FTE
Planning & Economic Development	4	665,620	252,000	8.50
Healthy and Safe Communities	1	1,039,500	1,039,500	10.00
Public Works	2	424,270	(89,530)	6.70
City Manager	1	0	0	1.00
Corporate Services	2	0	0	2.00
Total Business Cases	10	2,129,390	1,201,970	28.20

- The amounts above are not included in the 2020 preliminary budget
- If approved, would result in a 0.1% tax impact

2020 BUSINESS CASES

#	Dept.	Business Case Details	Gross Impact \$(000's)	Net Impact \$(000's)	FTE Impact
1	Planning & Economic Development	Converting Contract Positions to Permanent- Real Estate	323.6	0.0	3.00
2	Planning & Economic Development	Graffiti Management	252.0	252.0	3.50
3	Planning & Economic Development	Animal Adoption Program Coordinator	90.0	0.0	1.00
4	Planning & Economic Development	Transportation Development Review	0.0	0.0	1.00
5	Healthy and Safe Communities	Hamilton Paramedic Service Enhancement (Ambulance)	1,039.5	1,039.5	10.00

2020 BUSINESS CASES

#	Dept.	Business Case Details	Gross Impact \$(000's)	Net Impact \$(000's)	FTE Impact
6	Public Works	Converting Consultant Inspectors to In-house Permanent Technology Inspector & Student Inspectors	284.3	(89.5)	4.40
7	Public Works	Assistant Stadium Technicians Required for Tim Horton's Field to handle the addition of Forge's FC Soccer Games	140.0	0.0	2.30
8	City Manager	Return to Work Services Specialist- HR Employee Health and Labour Relations FTE request being funded by Fire	0.0	0.0	1.00
9	Corporate Services	Enhanced WSIB Payroll Processing Services	0.0	0.0	1.00
10	Corporate Services	Conversion of an FTE for IT Division from Temporary to Permanent	0.0	0.0	1.00
Total			2,129.4	1,202.0	28.20

27



MULTI-YEAR OUTLOOK

2021-2023

2021 – 2023 MULTI-YEAR OUTLOOK

Our Strategy & Performance

(v.3)
November 9, 2018

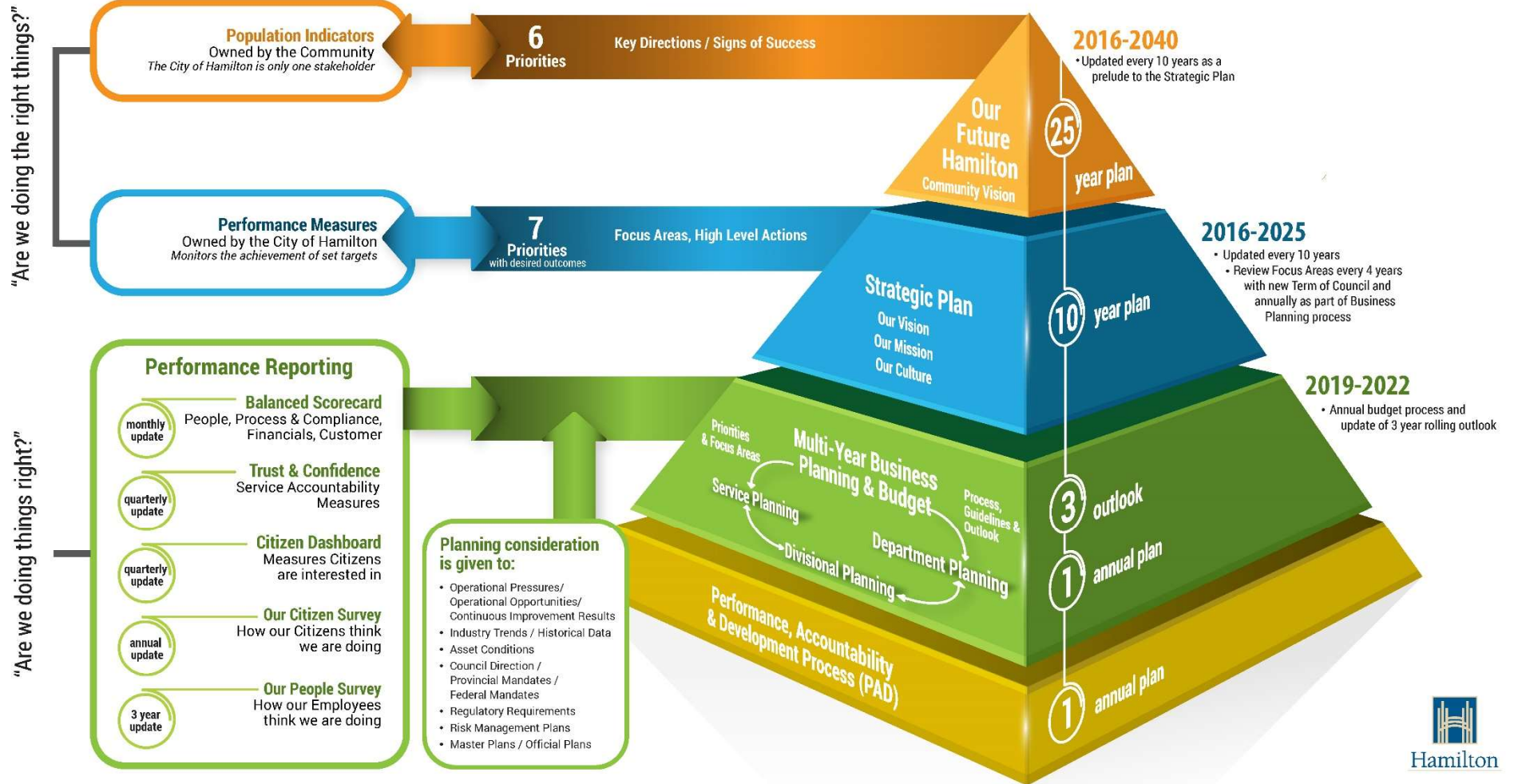

MULTI-YEAR OUTLOOK PROCESS

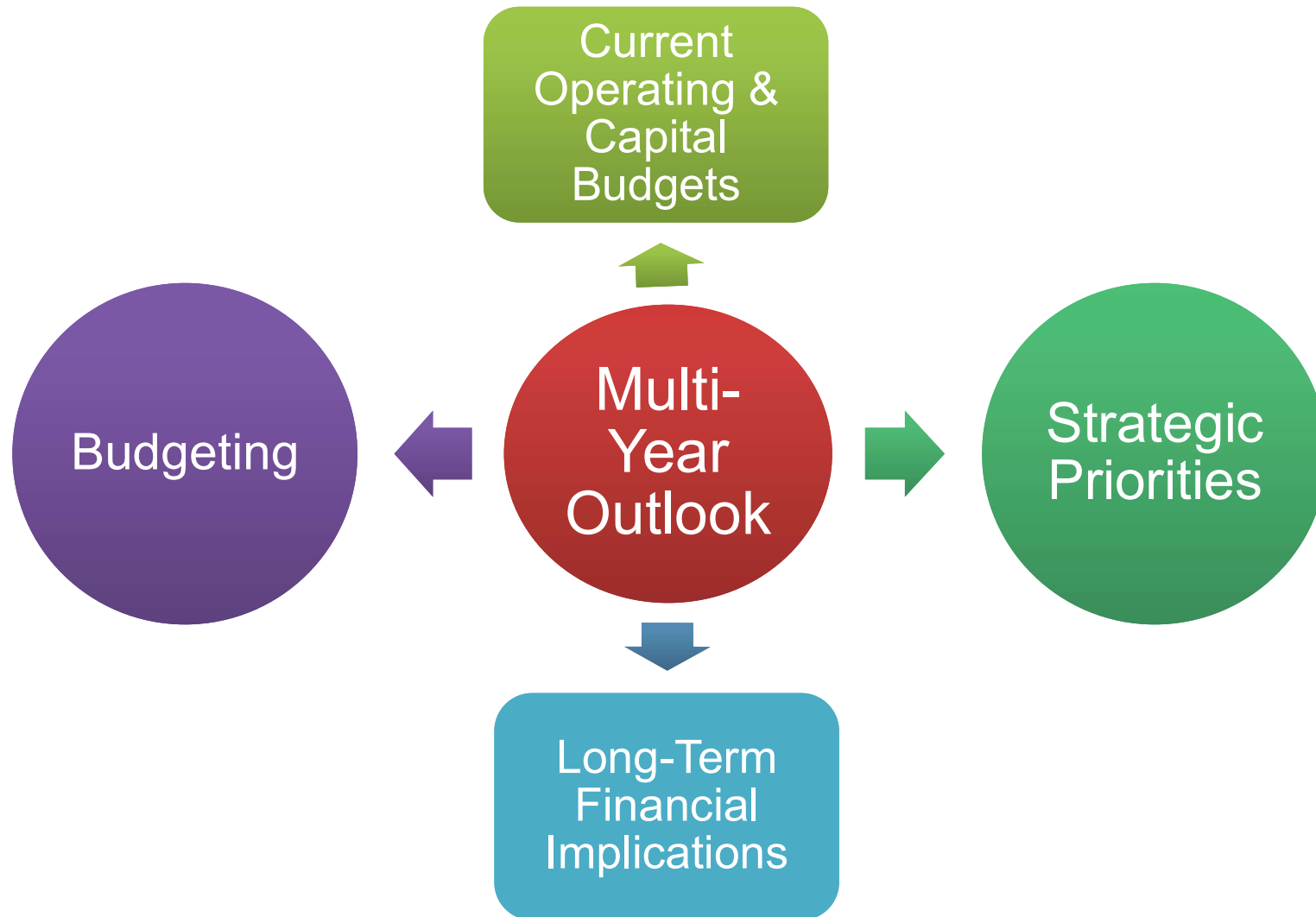

MULTI-YEAR OUTLOOK BUDGET INCREASE

(\$000's)

	Increase						
	2020	2021		2022		2023	
	\$	\$	%	\$	%	\$	%
Total City Departments	571,024	31,110	5.3%	18,739	3.0%	19,300	3.0%
Boards & Agencies	223,834	6,371	2.8%	6,474	2.8%	6,503	2.7%
Capital Financing	137,425	6,236	4.5%	5,815	4.0%	5,312	3.5%
Total Preliminary Operating Budget	932,283	43,717	4.7%	31,028	3.2%	31,115	3.1%
Residential Average Property Tax Impact *	4.5%		4.2%		2.7%		2.6%
Residential Average Property Tax Impact as projected in 2019 Budget	3.9%		3.6%		3.3%		
Difference	0.6%		0.6%		(0.6)%		

* - Municipal tax impact excluding education.

MULTI-YEAR OUTLOOK CITY DEPARTMENT DRIVERS

- Change in provincial funding and cost sharing agreements
- Continuing with the implementation of the 10-Year Transit Strategy and increases in DARTS contract due to increase ridership
- Operating impacts from capital projects
- Projected increases in capital financing based on staff recommendation

2020 PROCESS DATES

ITEM	DATE
Tax Supported Operating Budget Overview	January 17, 2020
Departmental Budget Presentations	January 28, 29, 30 & February 7, 2020
Boards & Agencies Presentations	January 21 & 23, 2020
Transit Day	January 24, 2020
Public Delegations	February 10, 2020
GIC Budget Deliberations	February 13, 24, 27, March 2 & 4, 2020
Council - Tax Operating Budget Approval	April 1, 2020



THANK YOU





PLANNING AND ECONOMIC DEVELOPMENT 2020 TAX SUPPORTED OPERATING BUDGET

January 17, 2020

OVERVIEW

Together with its partners, the Planning and Economic Development (PED) Department brings the City's Vision to life through effective planning for existing and future communities, processing of development applications, support for new and existing businesses, delivery of major infrastructure and development projects, support for the City's heritage, culture and arts, and ensuring the health, safety and well-being of the public through compliance with municipal by-laws.

SERVICES AND SUB-SERVICES

Building Permits and Zoning By-law Review

- AGCO Liquor License
- Applicable Law Review
- IC&I, and High Density Residential
- Low Density Residential
- Ontario Building Code PreConsultation

Building Inspections

- Building Code Inspections and Enforcement
- Enforcement of By-laws

Parking Operations

- Operations and Maintenance

By-Law Enforcement

- Lottery License
- Municipal Law Enforcement
- Parking Enforcement
- Public Complaints Handling
- Public Education
- Residential Care Facility Inspection
- Revenue Collection and Accounting
- Sign By-law
- Trade License
- Zoning Verification and Property Reports

Animal Services

- Municipal Law Enforcement
- Public Complaints Handling
- Public Education

Business Development

- Business Attraction and Retention

Growth Management

- Airport Lease Management/Liaison
- Growth Planning

School Crossing Guards

Urban Renewal

SERVICES AND SUB-SERVICES

Tourism Development

- Major Events
- Meetings and Conventions
- Sport Tourism
- Tourism Marketing
- Visitor Services and Visitor Centre

Heritage Resource Management

- Heritage Facility and Resource Management
- Heritage Policy, Initiatives and Strategies
- Museum Operations

Cultural Development

- Cultural Marketing
- Cultural Policies and Strategies
- Emerging Creative Sectors (Fashion)
- Events Development
- Film/Film Permits
- Music
- Public Art and Arts Development

Transportation Planning

- Sustainable Mobility and Active Transportation

Real Estate Property Management

Land Use Planning

- Official Plans
- Secondary Plans
- Special Studies (Community)
- Special Studies (Long-Range)

Development Approvals

- Approvals/Implementation
- Grading

2019 HIGHLIGHTS

2019 Highlights

Growth and Development

Year	Construction Value
2009	\$692,402,386
2010	\$1,096,299,091
2011	\$731,019,287
2012	\$1,499,627,394
2013	\$1,025,785,000
2014	\$1,143,192,846
2015	\$1,108,192,846
2016	\$1,056,237,746
2017	\$1,364,145,418
2018	\$1,264,757,129
2019	\$1,408,521,764 / \$1,538,521,764

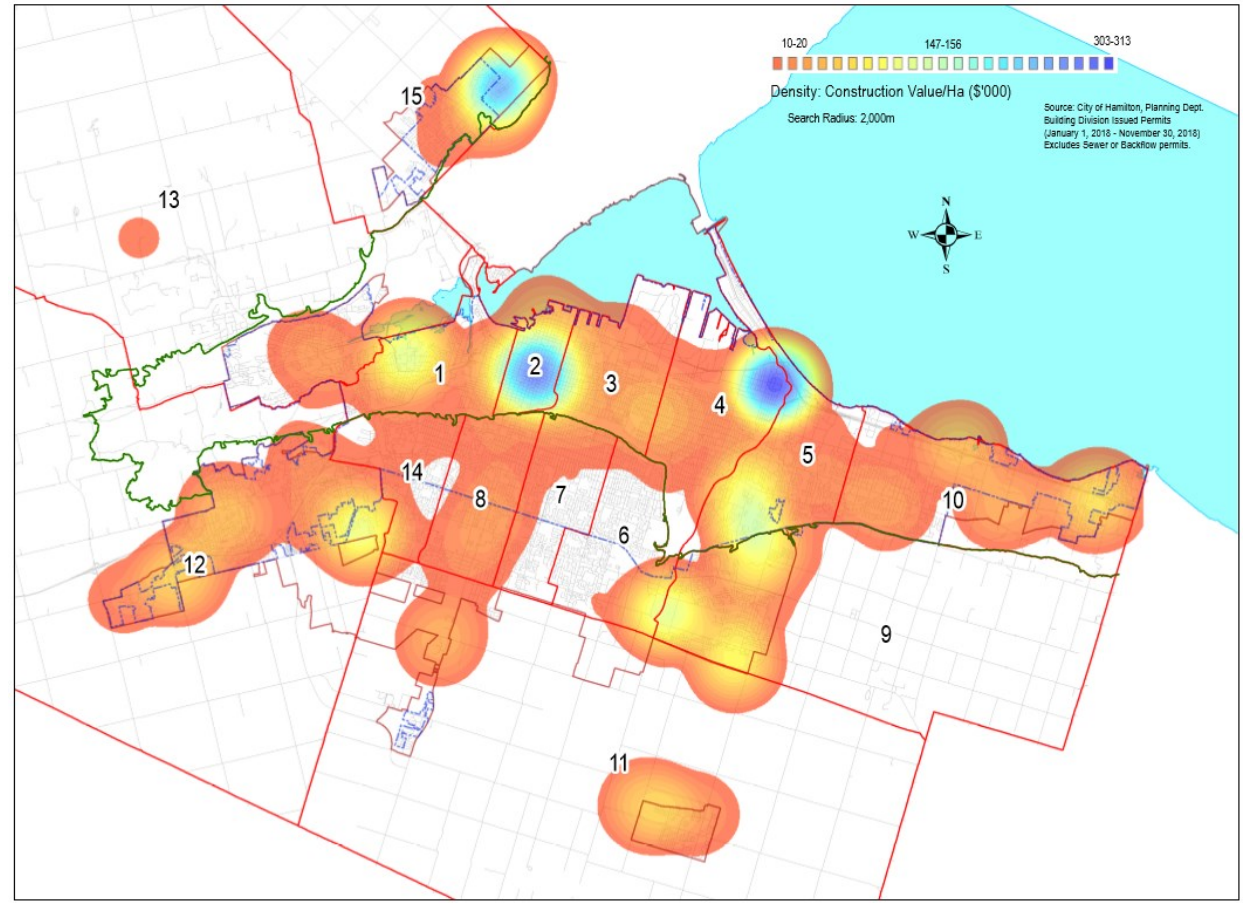

Building Permit Activity: Construction Value 2019

0 700 1,400 2,800 4,200 5,600 Meters

2019 Highlights

Growth and Development (cont'd)

Housing Units



2019 Highlights

Growth and Development (cont'd)

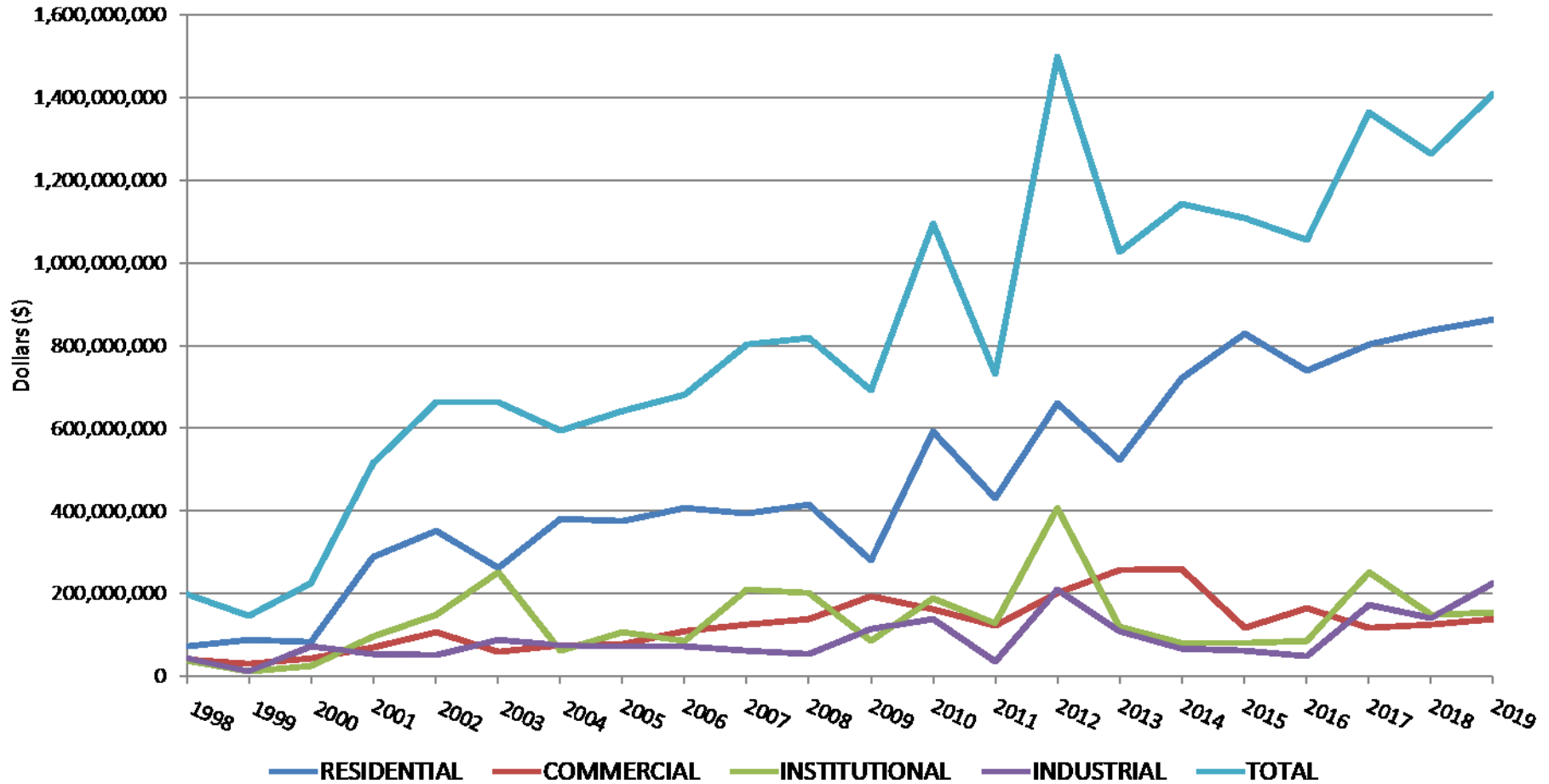

2019 Highlights

Growth and Development (cont'd)

Total Commercial and Industrial GFA (m²)

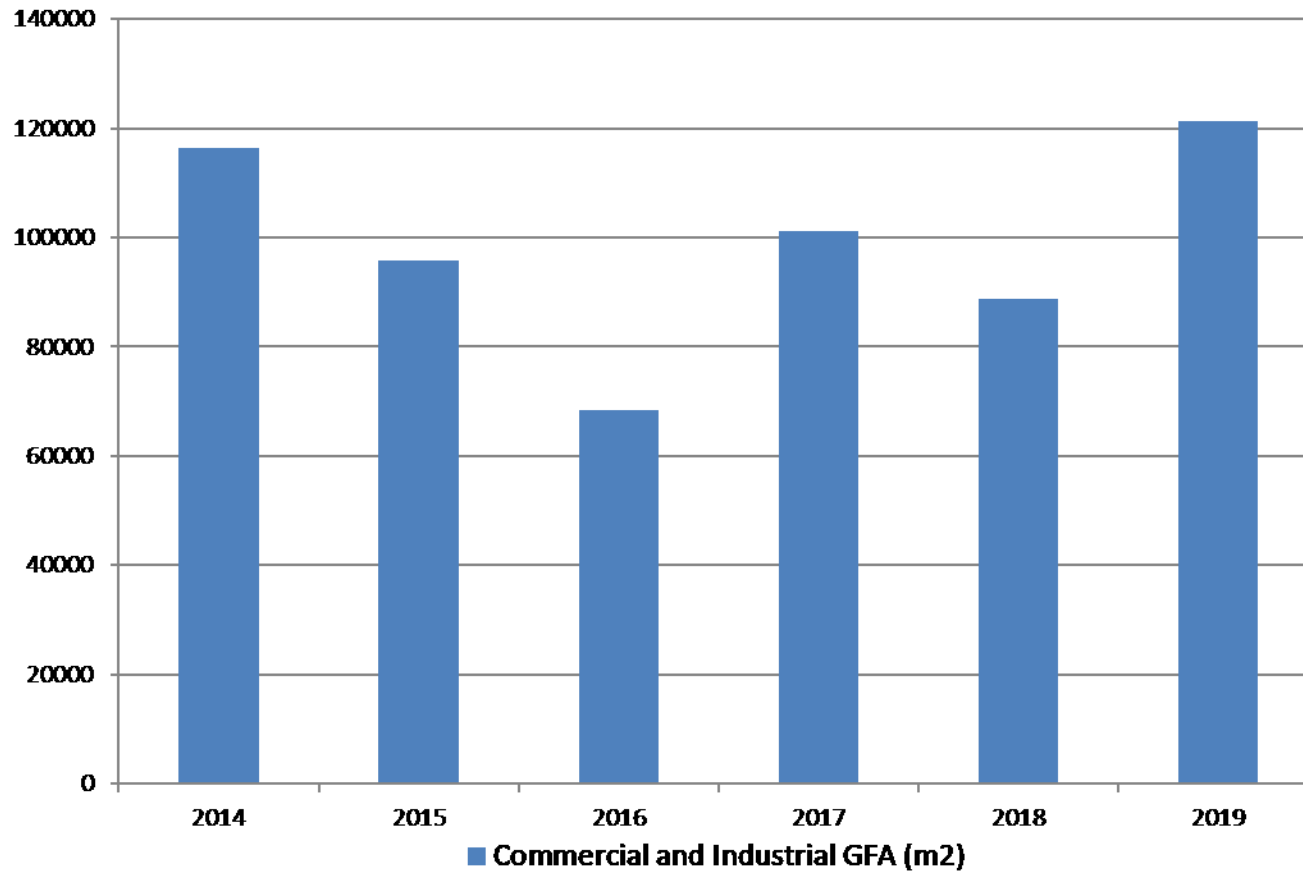

2019 Highlights

Growth and Development (cont'd)

Total Construction Value (incl. airport)	<i>Record Year</i>
Housing Units	<i>Record Year</i>
Industrial Construction	<i>Record Year</i>
Non-Residential GFA (incl. airport)	<i>Record Year</i>

2019 Highlights

Growth and Development (cont'd)

Building Permits Issued Per Year

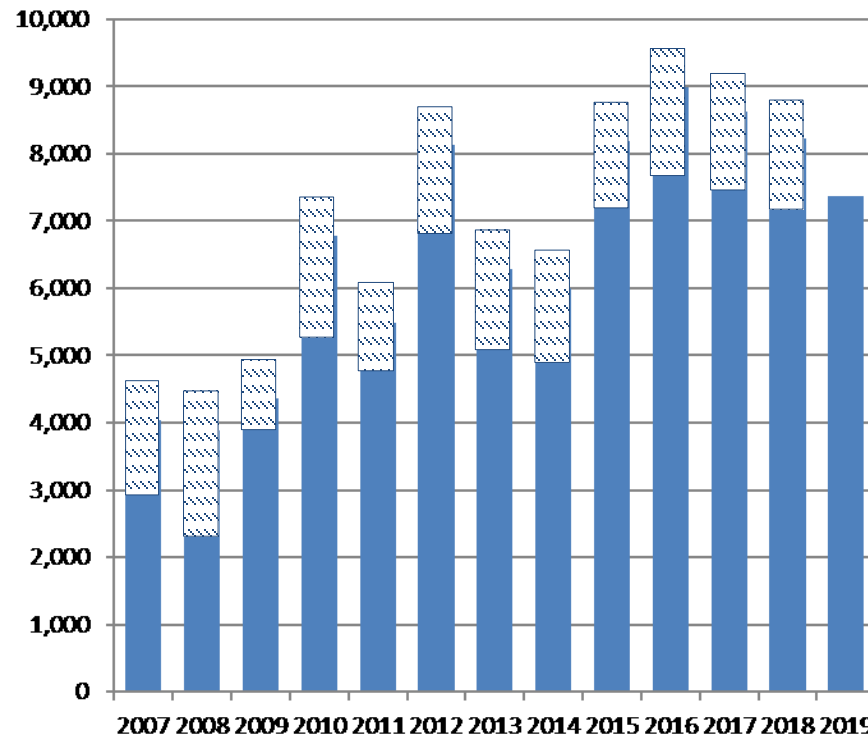

2019 Highlights

Growth and Development (cont'd)

Number of Development Applications

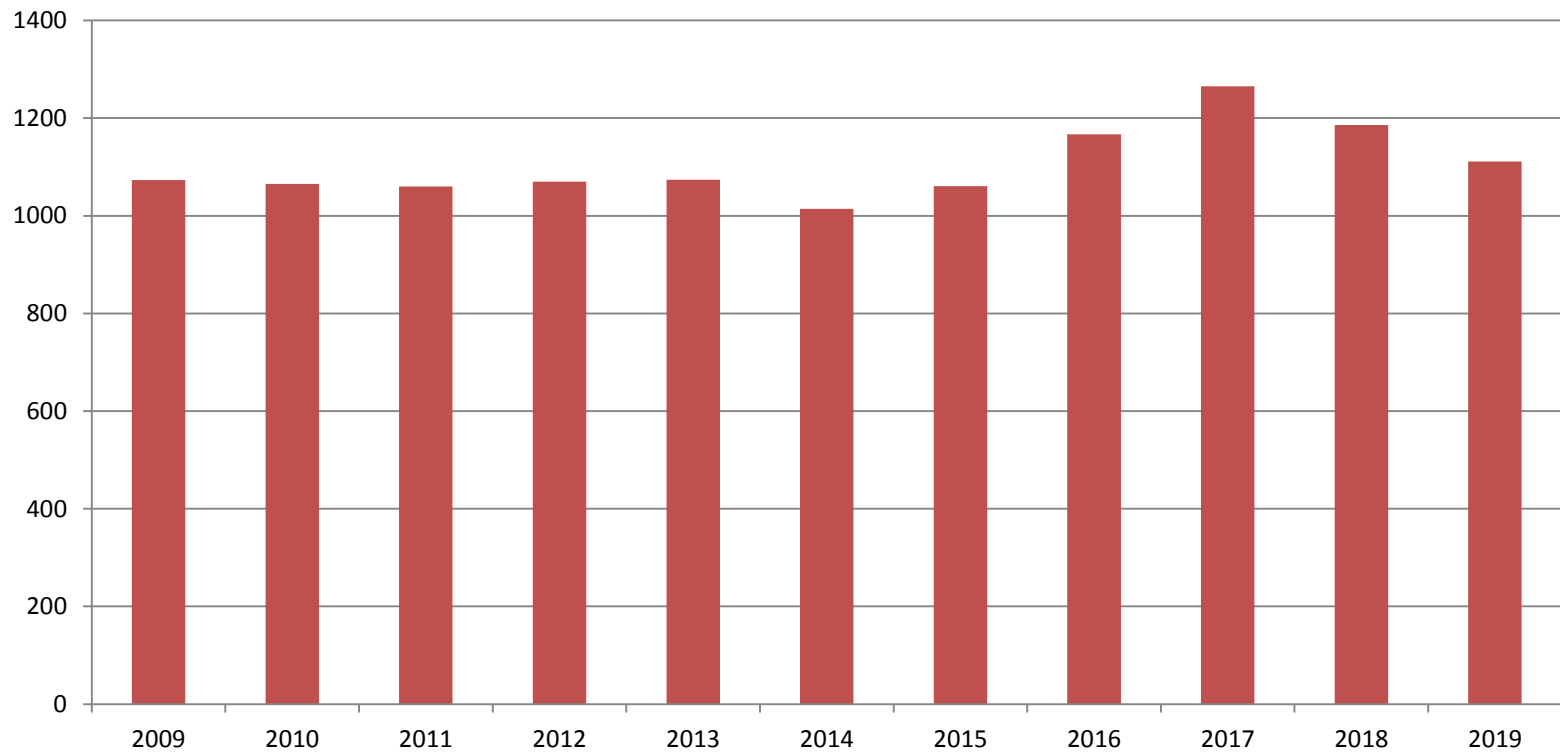

2019 Highlights

Culture & Economic Development

Total City-Wide Hotel Stays

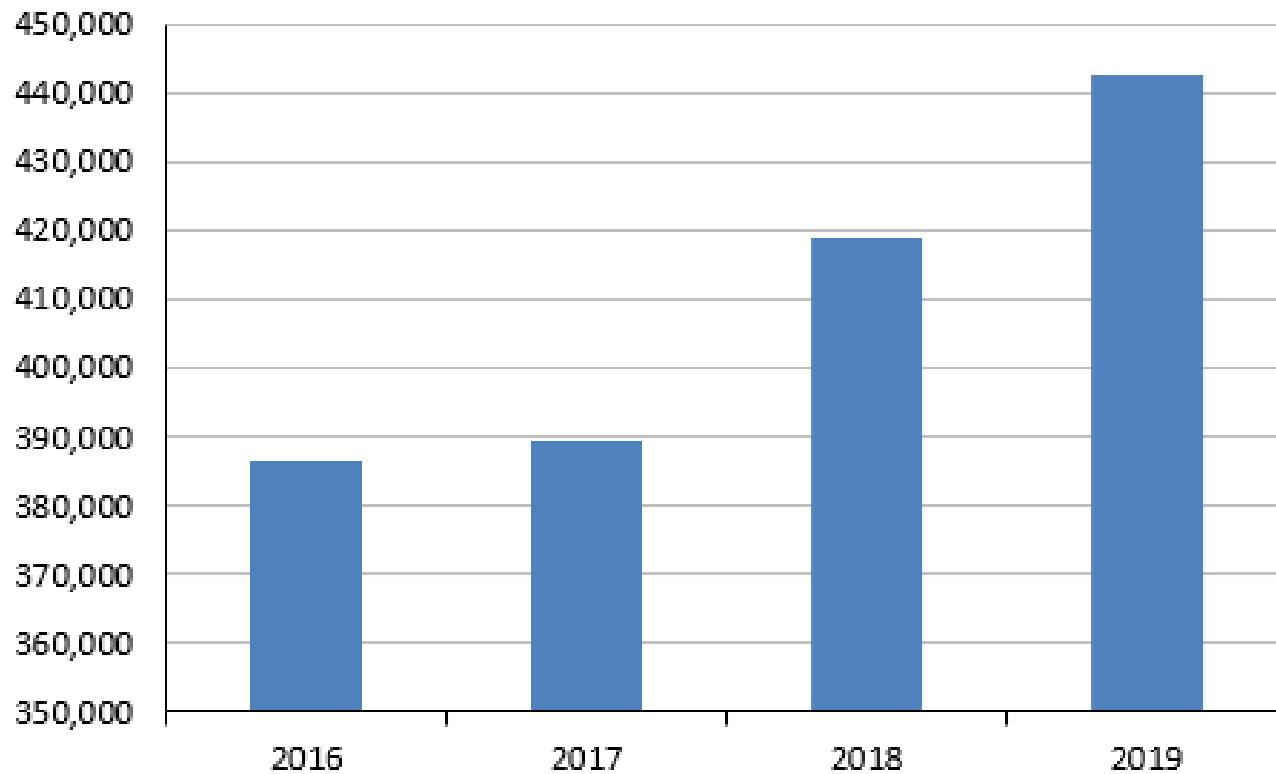

2019 Highlights

Culture & Economic Development (cont'd)

Total Number of Museum Admissions

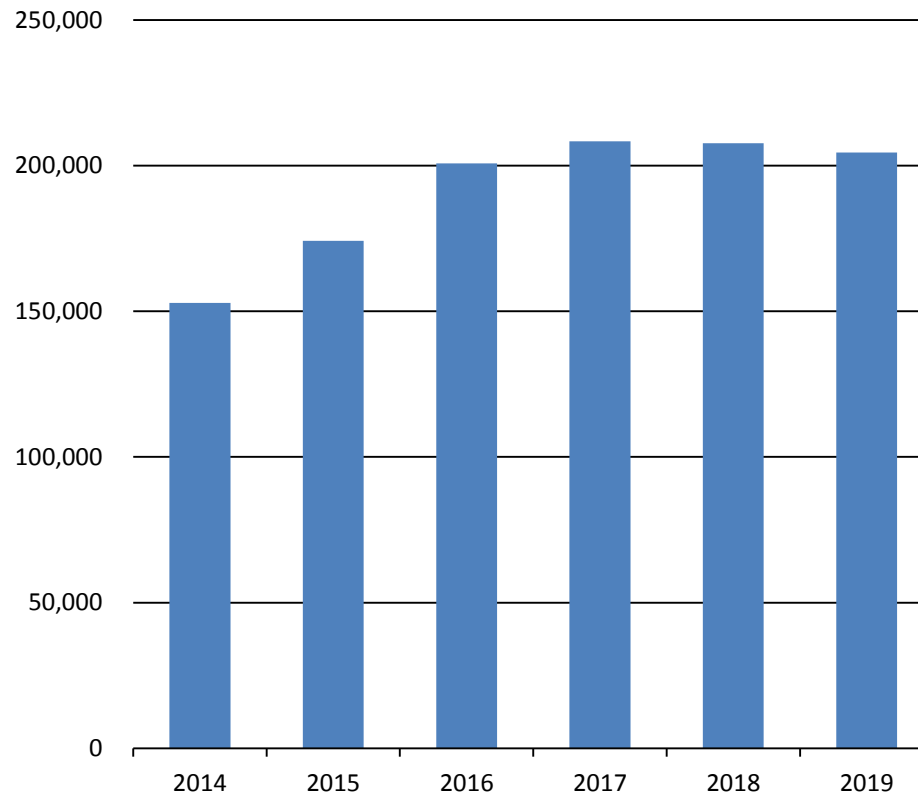

2019 Highlights

Culture & Economic Development (cont'd)

Number of Film Permits and Film Productions

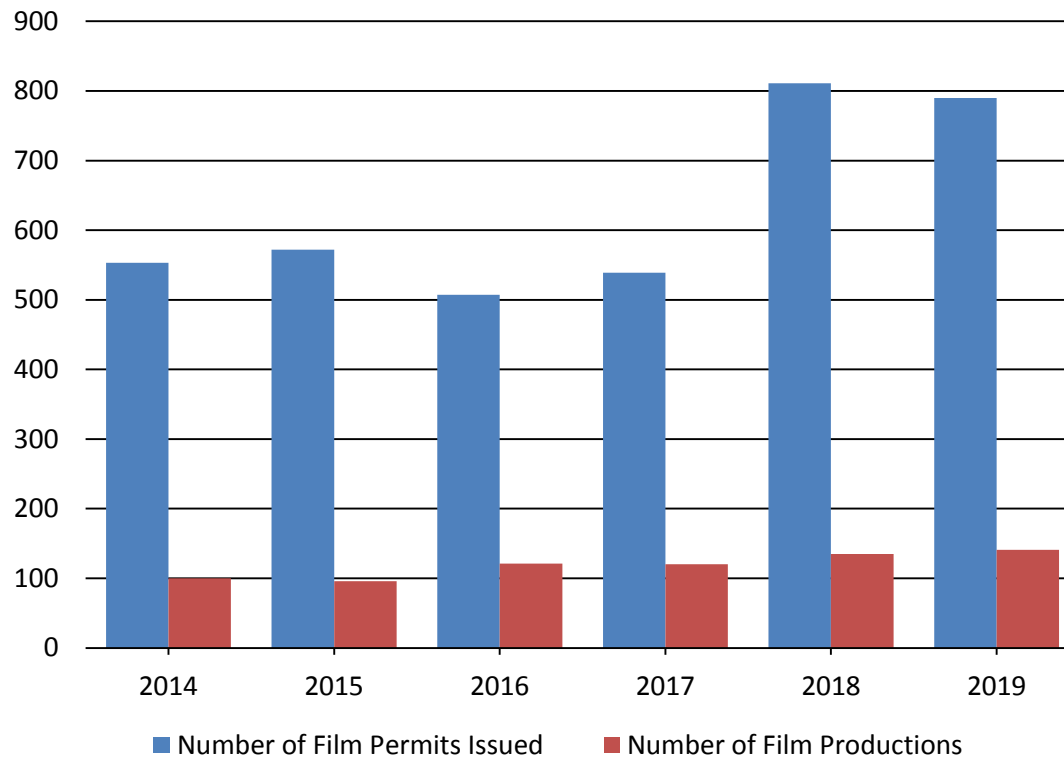

2019 Highlights

Infrastructure & Special Projects

- Road urbanizations:
 - Highland Road from Winterberry to Pritchard
 - First Road from Green Mountain Rd. to Mud Street
 - Upper Mount Albion from Rymal to Highland Rd.



2019 Highlights

Infrastructure & Special Projects (cont'd)

- New road construction / extensions:
 - Arvin Ave. from McNeilly Road to approx. 350 m westerly
 - Upper Sherman from south of Rymal Rd. to Nora Frances High School
 - Cormorant Road extension (grading and underground works)
 - North Waterdown Road from Mosaic Drive to 910 metres easterly
- Parking system improvements
- New and upgraded bicycle lanes and multi-use paths



17

2019 Highlights

Infrastructure & Special Projects (cont'd)

- Water and sewer works:
 - First Road watermain
 - Centennial Sanitary Tunnel and Binbrook Pumping Station Upgrades
 - Completion of Phase 1 Garner Road Sanitary Sub-trunk
 - SCUBE Block 2 Servicing Plan

- West Harbour
 - Settlement of LPAT appeal
 - Initiation of construction works for site servicing
 - Jamesville RFP
 - Disposition strategy for Pier 6/7 development blocks

2019 Highlights

By-law Enforcement & Animal Control

Calls Attended by Officer per Year

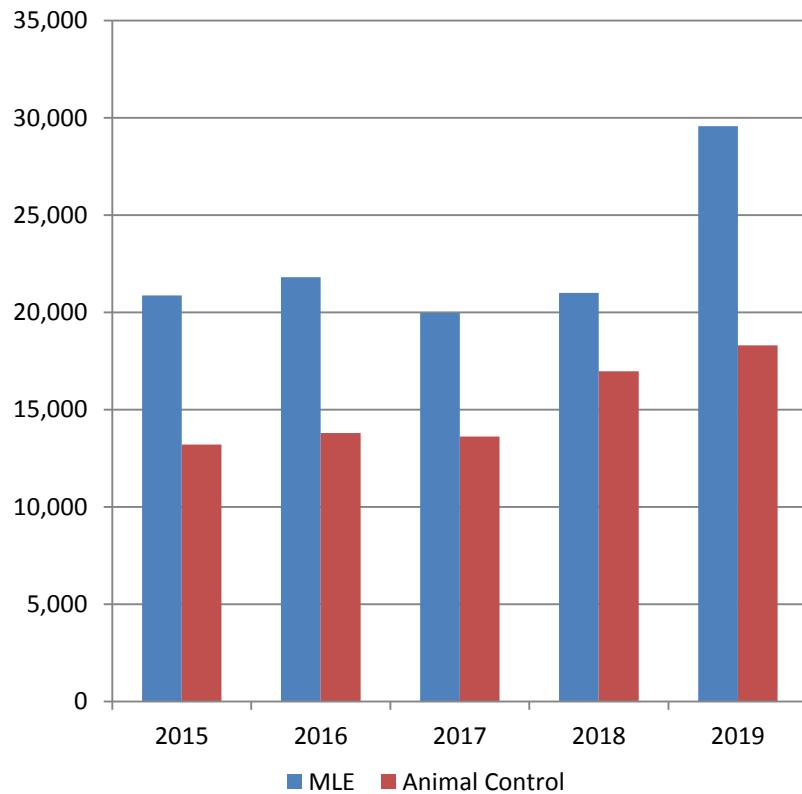

Animal Licenses Sold

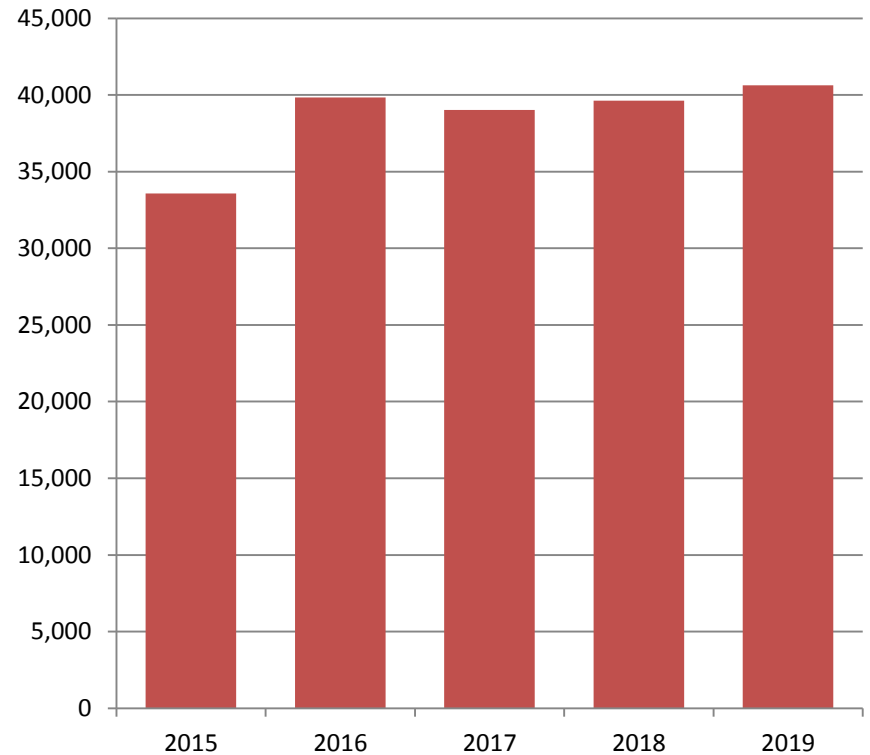

KEY PERFORMANCE INDICATORS

Key Performance Indicators

Official Plan/Zoning By-Law Amendments

Approval Timelines - Reports to Planning Committee

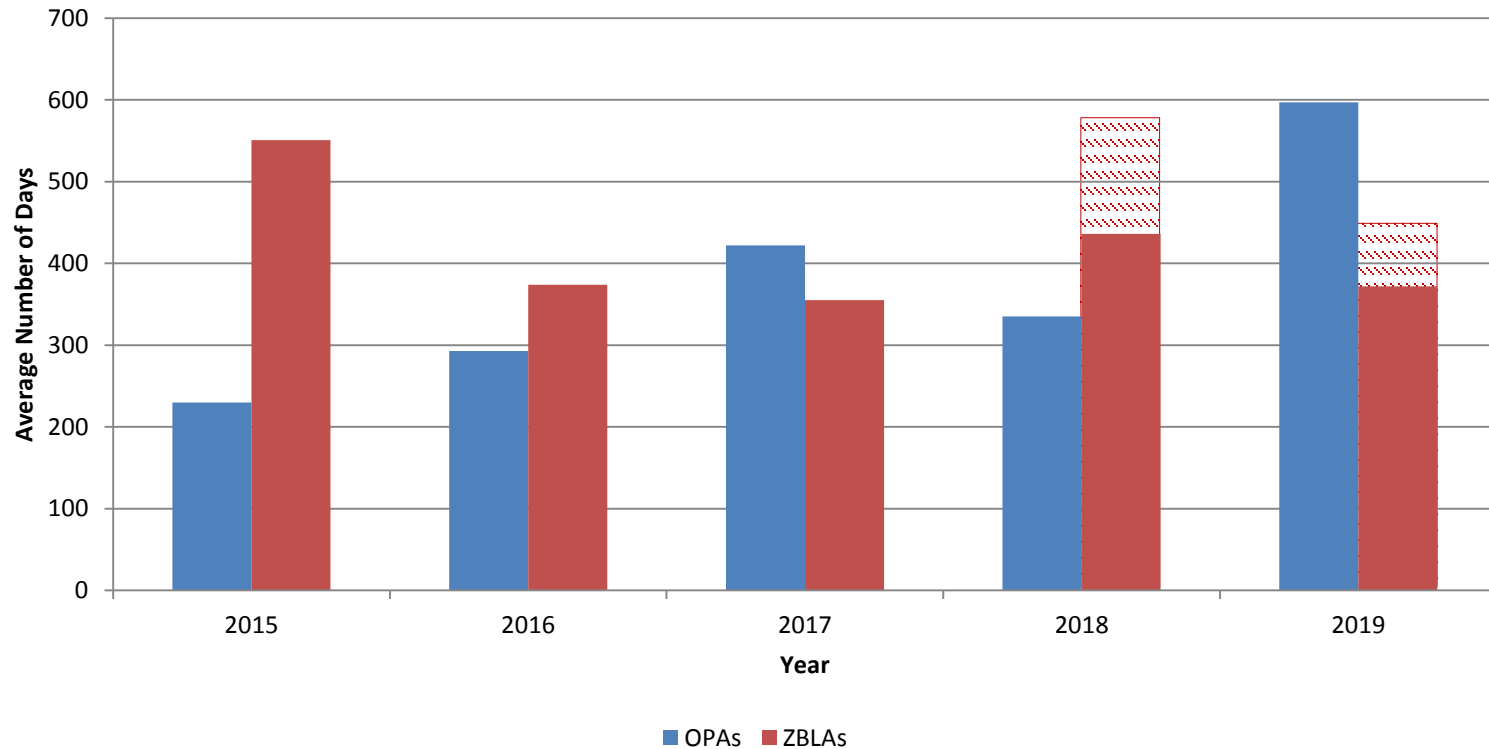

Key Performance Indicators

Official Plan/Zoning By-Law Amendments

Average Number of Days to Complete a Zoning Review for Planning Files

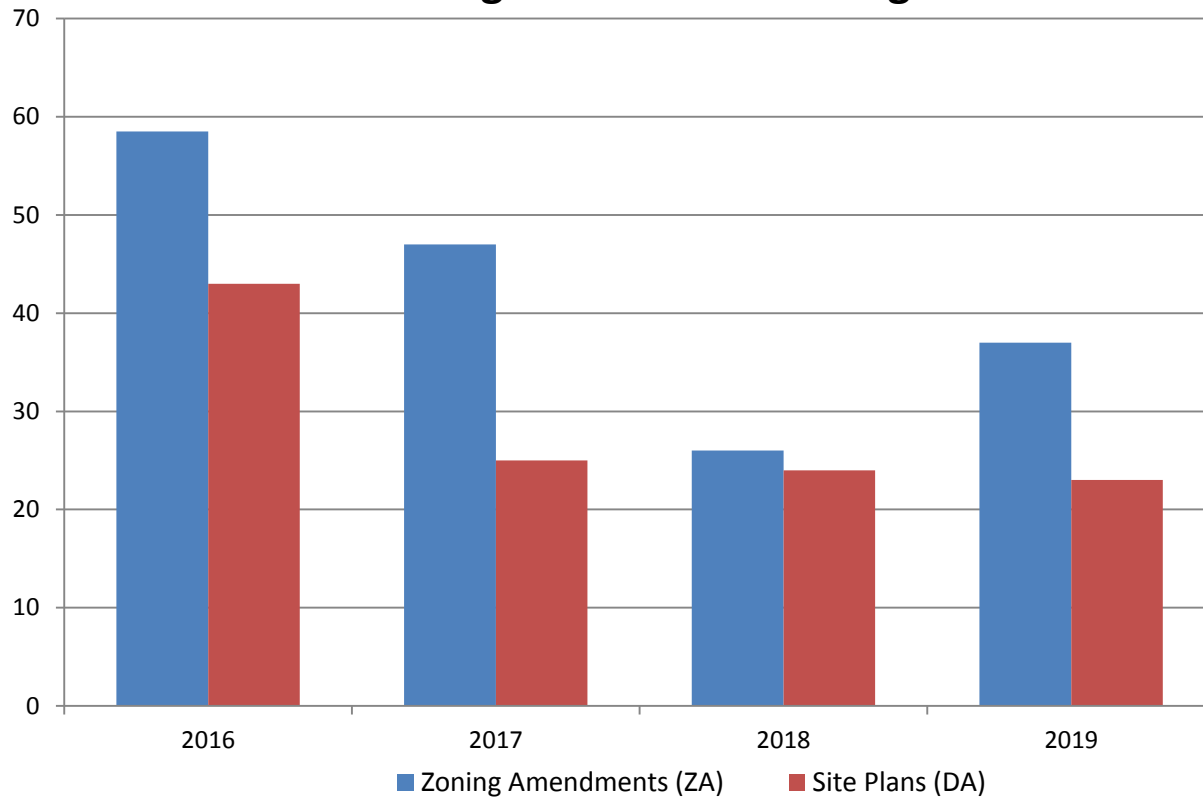

Key Performance Indicators

Subdivisions

Approval Timelines - Draft Plans to Planning Committee

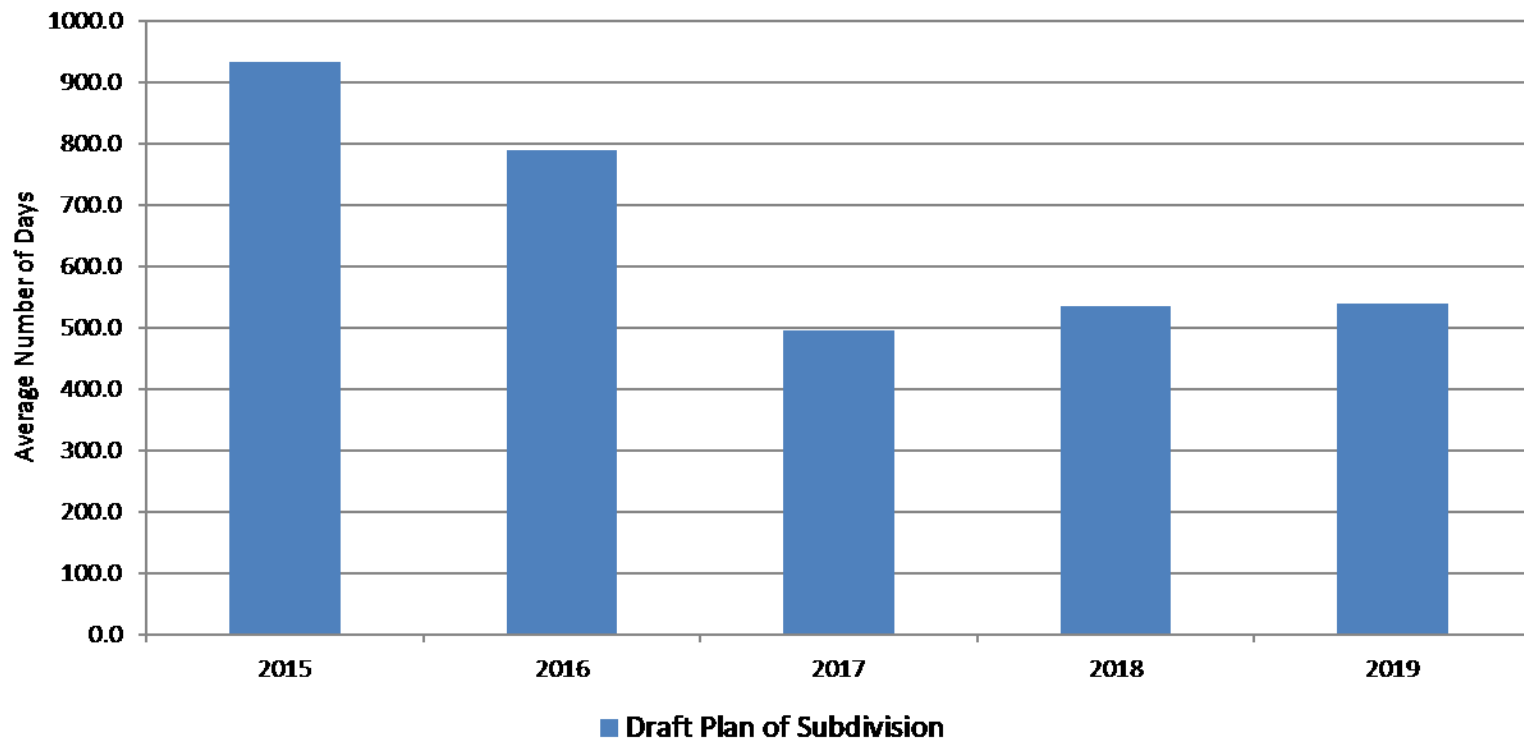

Key Performance Indicators

Engineering Submissions

Processing Time for Engineering Submissions (Subdivisions)

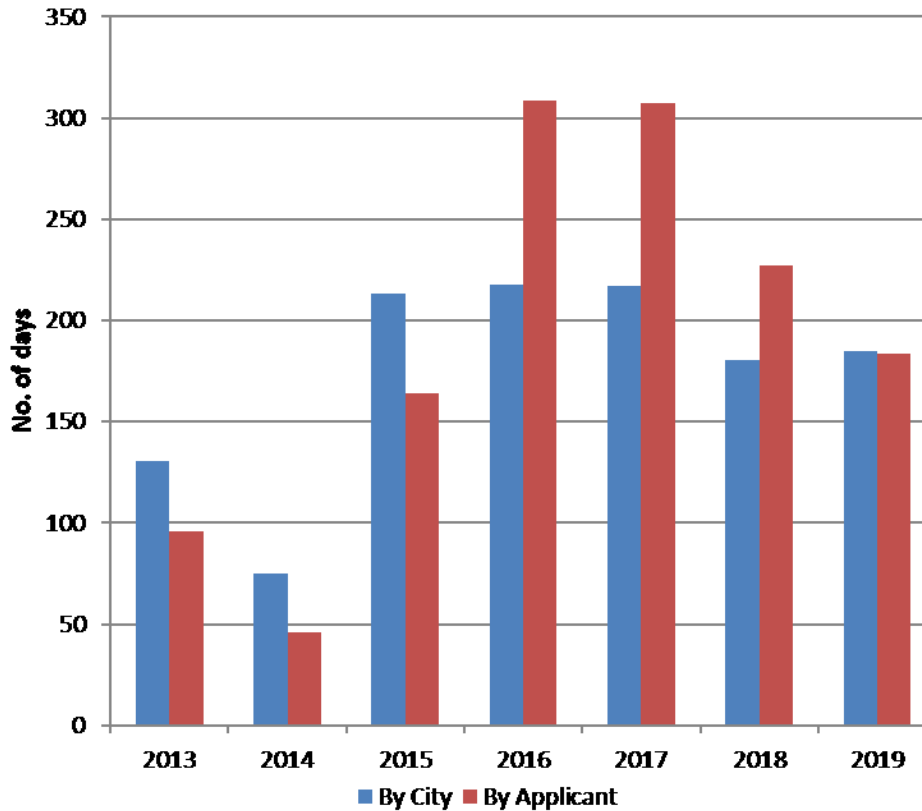

Processing Time for Engineering Submissions (Site Plan)

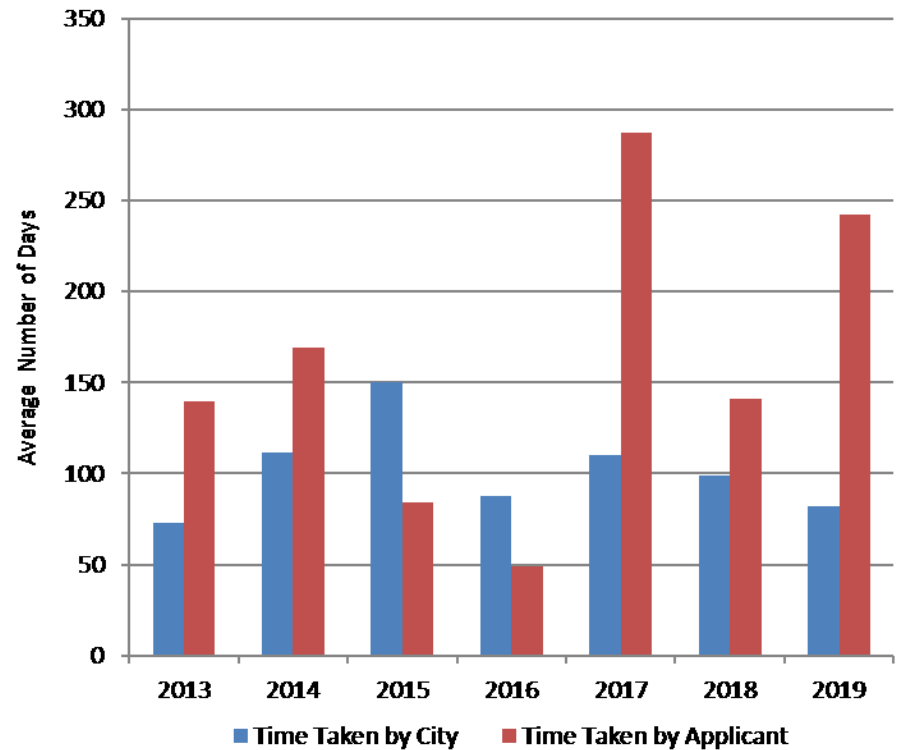

Key Performance Indicators

Committee of Adjustment

**Average Number of Days to get to Hearing for
a Minor Variance and Consent Application**

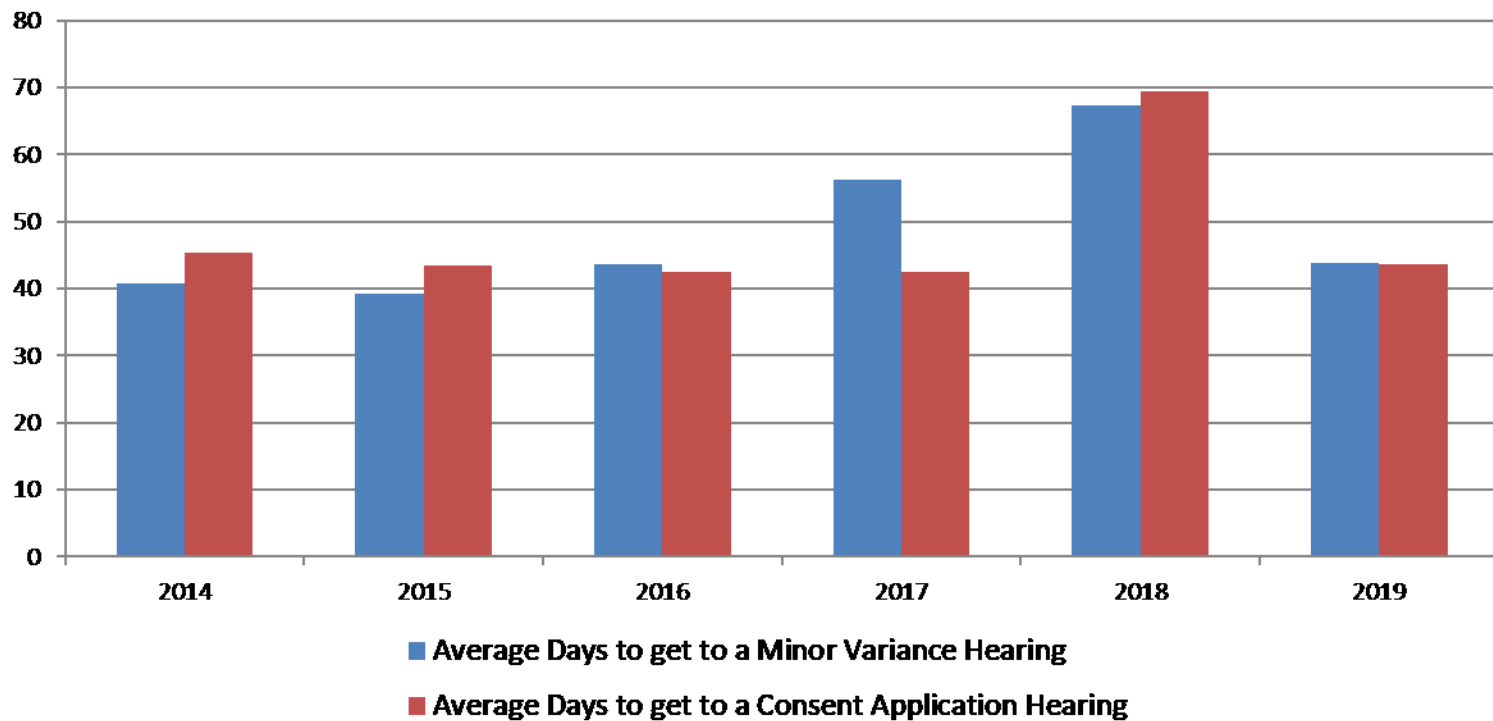

Key Performance Indicators

Building Permits

Average First Review Time for Building Permits

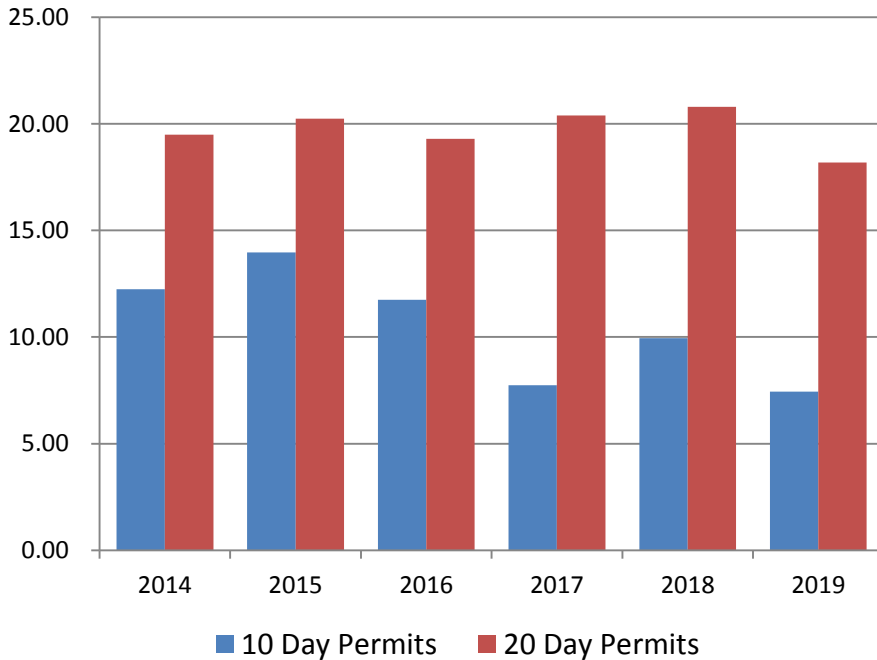

% of Applications Reviewed within 5 Days of Statutory Timeline

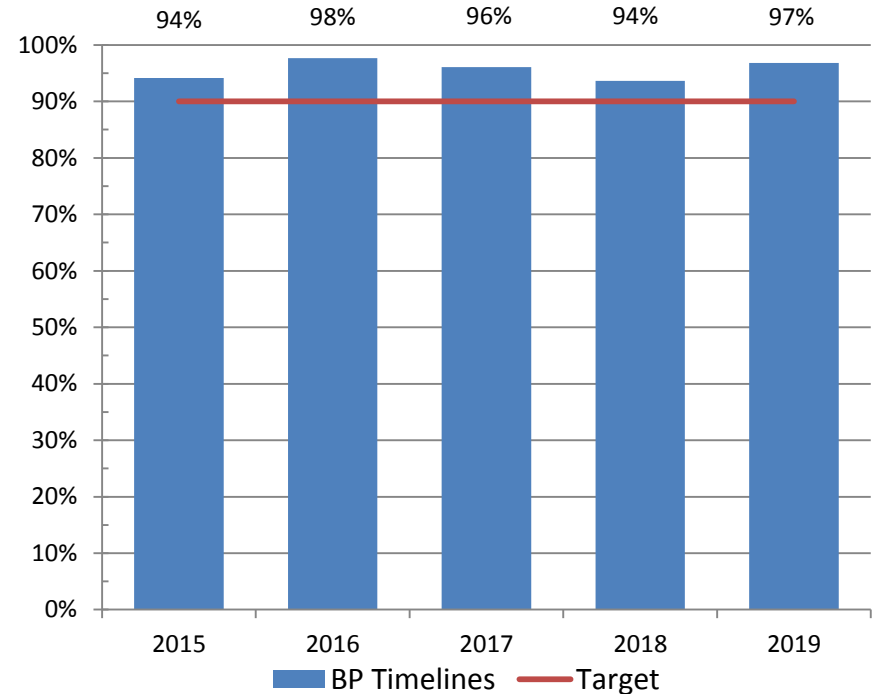

Key Performance Indicators

Business Licenses

Approval Timelines – New Business Licenses

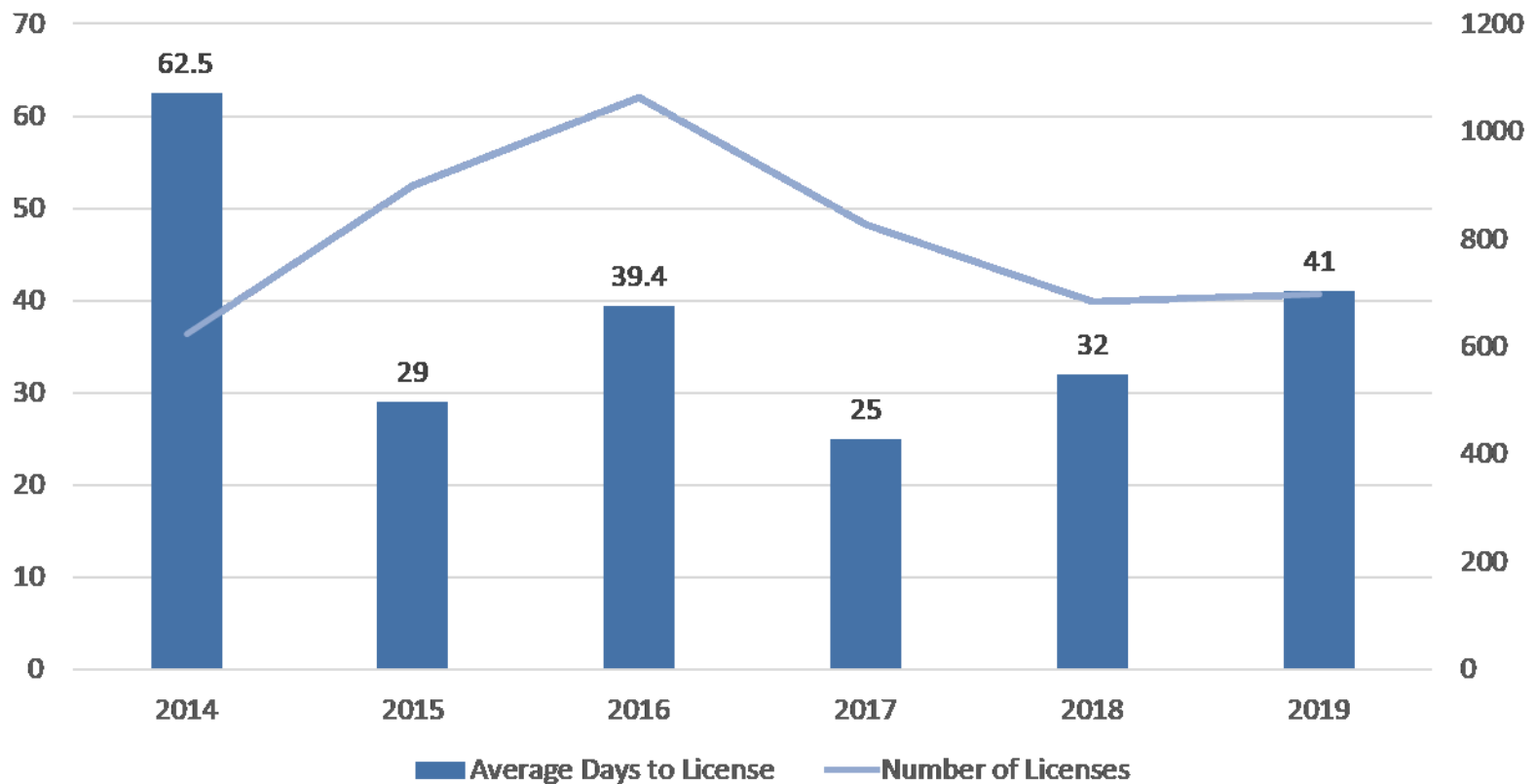

Key Performance Indicators

Transportation Planning Reviews

Transportation Development Reviews Outstanding Balance - 2018/2019

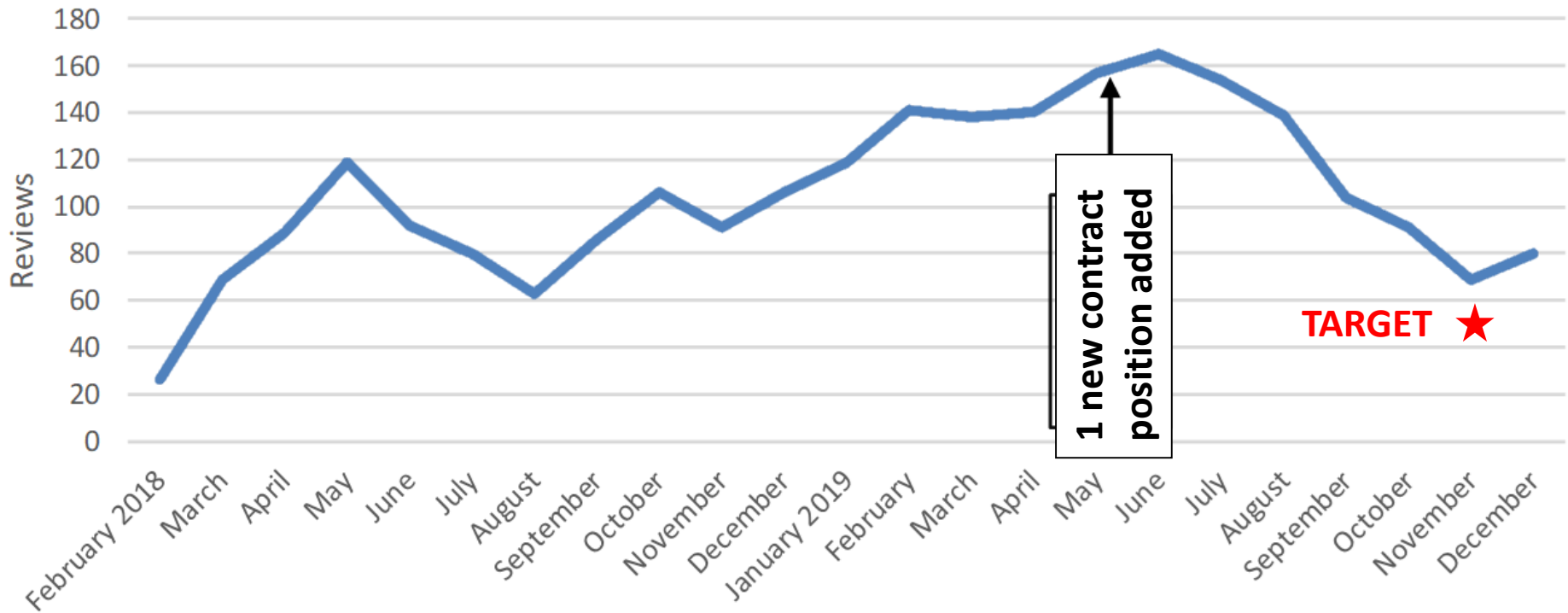

TRENDS & ISSUES 2020-2023

Departmental Trends & Issues 2020-2023

Development Outlook

	2016	2017	2018	2019	2020
	Actual	Actual	Actual	Actual	Projected
OPA All Types	27	41	25	16	18
ZBA All Types	67	87	59	54	59
Subdivision	18	10	11	5	6
Site Plans All Types	192	234	223	179	188
Variances All Types	444	470	428	466	444
Consents	107	114	157	135	114

Departmental Trends & Issues 2020-2023

Critical Growth-Related Infrastructure

- Waterdown Sanitary Pumping Station
- North Waterdown Road
- Mewburn neighbourhood SWM facility
- AEGD Pumping Station upgrades
- Dickenson Road urbanization and extension of trunk to AEGD
- Rymal Rd. / Hwy. 56 road urbanizations
- Lower Stoney Creek pumping station capacity

Departmental Trends & Issues 2020-2023

Staffing and Resourcing

- Workload
- Pending retirements
- Recruitment challenges



2020 KEY INITIATIVES

Departmental Key Initiatives 2020

- Planning for Future Growth
 - GRIDS2
 - Residential zoning by-law
 - Planning for Waterdown and Dundas nodes

- Growth-Related Infrastructure
 - SCUBE Block 1 and 3 Servicing Plans
 - Garner Road sanitary sub-trunk extension
 - Environmental Assessments for Gordon Dean Road, Dickenson Road, Upper Red Hill Valley Parkway/Twenty Road Extension and Highway #8
 - North Waterdown Road Phase 2 (connection to Centre Rd.)
 - AEGD servicing key infrastructure projects

Departmental Key Initiatives 2020

- Transportation Planning
 - A-Line functional design
 - LINC/RHVP Feasibility Study
 - 24 cycling infrastructure projects
 - Parking Master Plan
 - Truck Route Master Plan



Departmental Key Initiatives 2020

- Tourism, Culture & Economic Development

- Development of 2021 – 2026 Economic Development Action Plan
- Updates to sector strategies for Advanced Manufacturing, Life Sciences and Foreign Direct Investment
- Music Sector Economic Impact Study
- Tourism Strategy update
- Bayfront Strategy



Departmental Key Initiatives 2020

- West Harbour
 - Finalization of Pier 8 development agreement and completion of servicing
 - Execution of Pier 6/7 disposition strategy
 - Pier 6/7 interim animation strategy
 - Construction of Copps' Pier (Pier 8 promenade park)



Departmental Key Initiatives 2020

- Climate Change
 - Development guidelines (Site Plan, Engineering, Complete Streets)
 - Green building initiatives
 - Urban Forest Strategy
 - Community Energy Plan
 - Energy and environment reporting for new development
 - Cycling and parking initiatives

Departmental Key Initiatives 2020

- Open For Business
 - Hamilton Chamber of Commerce and Hamilton-Burlington Society of Architects reviews
 - Partnering Agreements with Public Works
 - Site Plan Guidelines (include Tree Preservation Plan guidelines)
 - Transportation Planning reviews
 - Digital submissions and AMANDA platform

The screenshot displays the Hamilton EPLANS application interface. At the top left is the Hamilton logo. On the top right, the user is identified as 'eplansuser@gmail.com (EPLANS INCORPORATED)'. A progress bar below the header shows five steps: 1 Choose property, 2 Enter details (highlighted in blue), 3 Fees, 4 Documents, and 5 Summary. Below the progress bar, a red asterisk indicates a mandatory field. The main content area shows 'Part 9 - Residential > Folder Infos'. Underneath, it provides detailed information for application # 2019 100223 000 00 R9, including the application type (Part 9 - Residential/Boarding House/New Construction), the property address (222 EMERSON STREET, HAMILTON ON), and the project description (test).

2020 PRELIMINARY TAX OPERATING BUDGET

Organizational Chart

General Manager
Jason Thorne

Manager, Strategic Continuous
Improvement & Open for Business
Robert Lalli (4.0)

Administrative Coordinator
Laura McDavid
(1.0)

Director Strategic Initiatives
Marty Hazell (3.0)

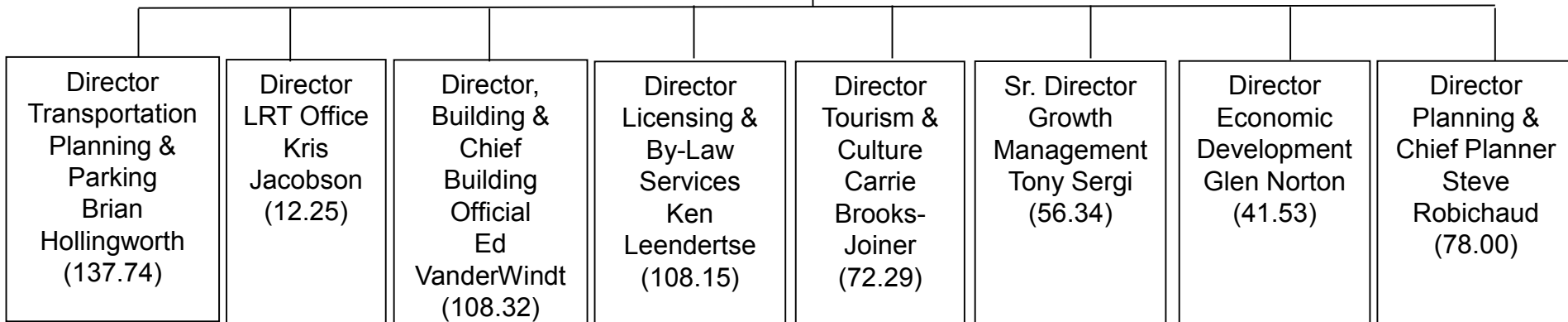

Complement (FTE)	Management	Other	Total	Staff to Mgmt. Ratio
2019	39.50	585.12	624.62	14.81:1
2020	39.50	584.12	623.62	14.79:1
Change	0.00	(1.00)	(1.00)	

2020 Operating Budget By Division

	2019	2020	2020	\$	%
	Restated	Preliminary	Preliminary		
	Net	Gross	Net		
General Manager	1,021,680	1,217,250	1,038,090	16,410	1.6%
Transportation, Planning and Parking	2,148,020	16,630,320	2,443,710	295,690	13.8%
Building	1,273,970	14,880,730	1,060,690	-213,280	(16.7%)
Economic Development	5,359,750	8,837,830	5,421,470	61,720	1.2%
Growth Management	405,240	6,819,740	590,820	185,580	45.8%
Licensing & By-Law Services	6,615,610	12,670,260	6,645,950	30,340	0.5%
LRT Office	0	9,196,740	0	0	0.0%
Planning	3,368,470	8,977,150	3,742,270	373,800	11.1%
Tourism & Culture	9,141,260	10,617,550	9,219,540	78,280	0.9%
Total Planning & Economic Development	29,334,000	89,847,570	30,162,540	828,540	2.8%
				With proposed budget mitigations	1.1%

2020 Departmental Budget Drivers

- Cost drivers:
 - Employee Related Costs - \$1.4 M
 - Property Taxes - \$112,000
 - Development Fee Revenues
 - Reserve Contributions – (\$781,000)

- Budget mitigations:
 - 2019 development fee increase
 - Review of revenues and expenses against historical averages
 - Changes to user fees
 - Parking rate increase (TBC)

Multi-Year Outlook

	Preliminary	Multi-Year Outlook					
	2020	2021		2022		2023	
	Budget \$	Budget \$	%	Budget \$	%	Budget \$	%
PED Department (excludes major drivers)	30,162,540	30,094,930	-0.2%	31,678,110	-0.1%	31,679,130	-0.1%
Major Drivers							
Employee Related		1,543,160		1,476,630		1,386,540	
Fees and General Revenues		77,140		(1,447,850)		(678,830)	
Total PED Department	30,162,540	31,715,230	5.1%	31,706,890	0.0%	32,386,840	2.1%

2020 PRELIMINARY TAX OPERATING BUDGET

General Manager

2020 Operating Budget by Section

	2019	2020	2020	\$	%
	Restated	Preliminary	Preliminary		
	Net	Gross	Net		
Strategic Initiatives	386,450	368,740	368,740	(17,710)	(4.6%)
GM Office	635,230	848,510	669,350	34,120	5.4%
Total General Manager	1,021,680	1,217,250	1,038,090	16,410	1.6%

2020 PRELIMINARY TAX OPERATING BUDGET

Building

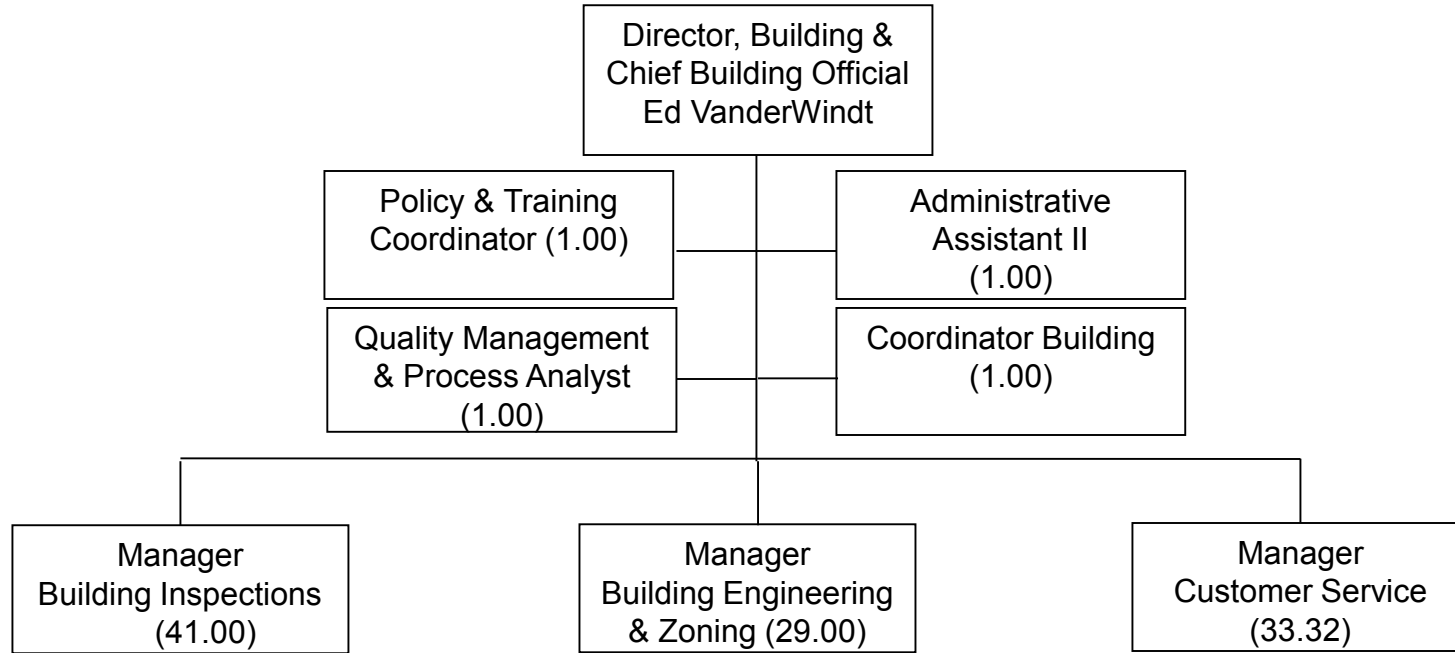

Complement (FTE)	Management	Other	Total	Staff to Management Ratio
2019	4.00	104.32	108.32	26.08
2020	4.00	104.32	108.32	26.08
Change	0.00	0.00	0.00	

2020 Operating Budget by Section

	2019	2020	2020	\$	%
	Restated	Preliminary	Preliminary		
	Net	Gross	Net		
Administration - Building Serv	280,000	282,150	278,150	-1,850	(0.7%)
Building Inspections	623,680	617,370	617,370	-6,310	(1.0%)
Engineering & Zoning Services	182,380	1,324,810	-57,660	-240,040	(131.6%)
Enterprise Model	-32,510	12,433,570	0	32,510	(100.0%)
Plan Examination Sec	220,420	218,740	218,740	-1,680	(0.8%)
Total Building	1,273,970	14,880,730	1,060,690	-213,280	(16.7%)

2020 PRELIMINARY TAX OPERATING BUDGET

Economic Development

Organizational Chart

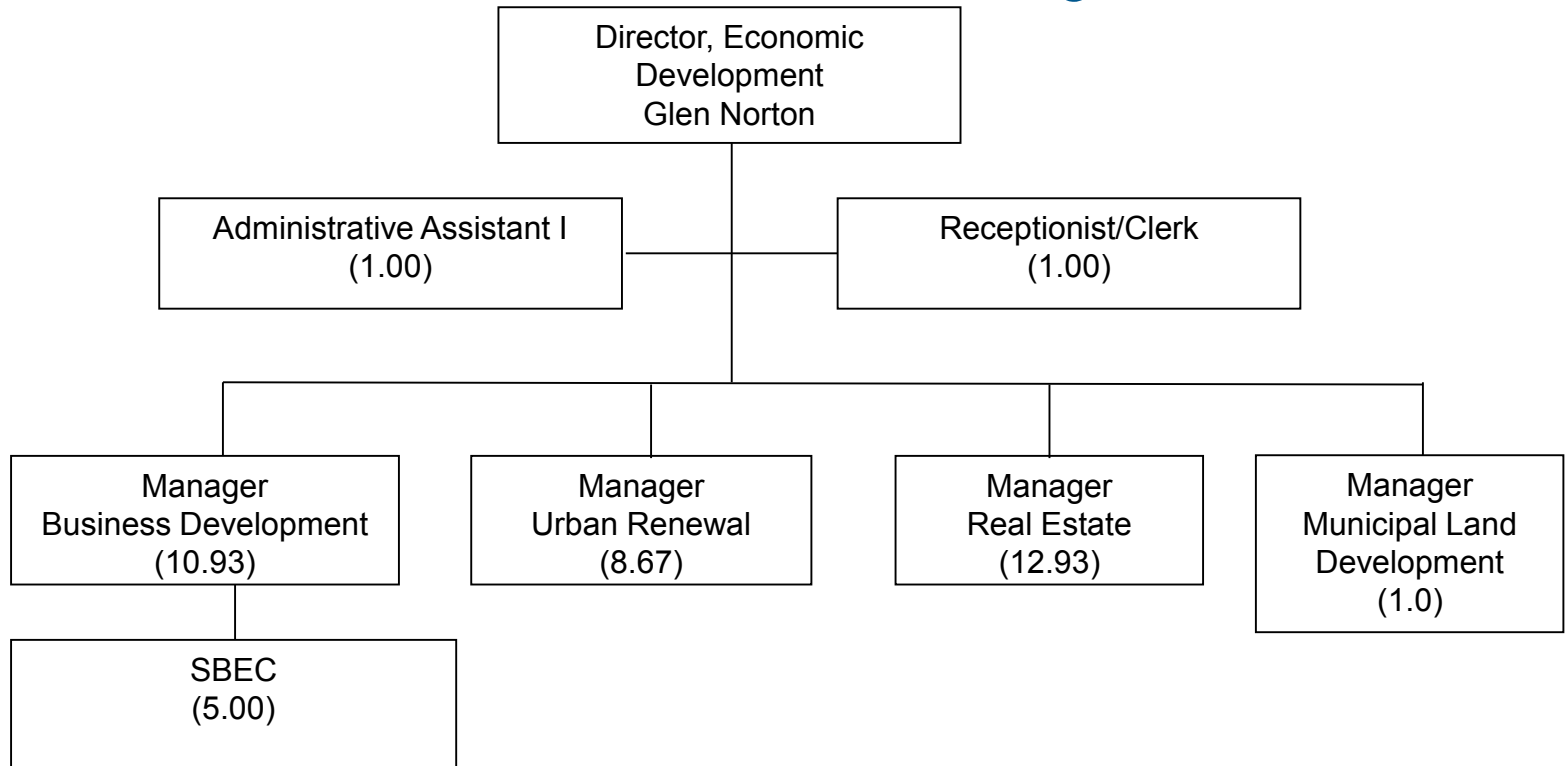

Complement (FTE)	Management	Other	Total	Staff to Management Ratio
2019	5.00	36.53	41.53	7.31:1
2020	5.00	36.53	41.53	7.31:1
Change	0.00	0.00	0.00	

2020 Operating Budget by Section

	2019	2020	2020	\$	%
	Restated	Preliminary	Preliminary		
	Net	Gross	Net		
Business Development	3,074,510	3,555,940	3,147,710	73,200	2.4%
Real Estate	962,250	2,407,870	920,060	(42,190)	(4.4%)
Urban Renewal	1,322,990	2,874,020	1,353,700	30,710	2.3%
Total Economic Development	5,359,750	8,837,830	5,421,470	61,720	1.2%

2020 PRELIMINARY TAX OPERATING BUDGET

Growth Management

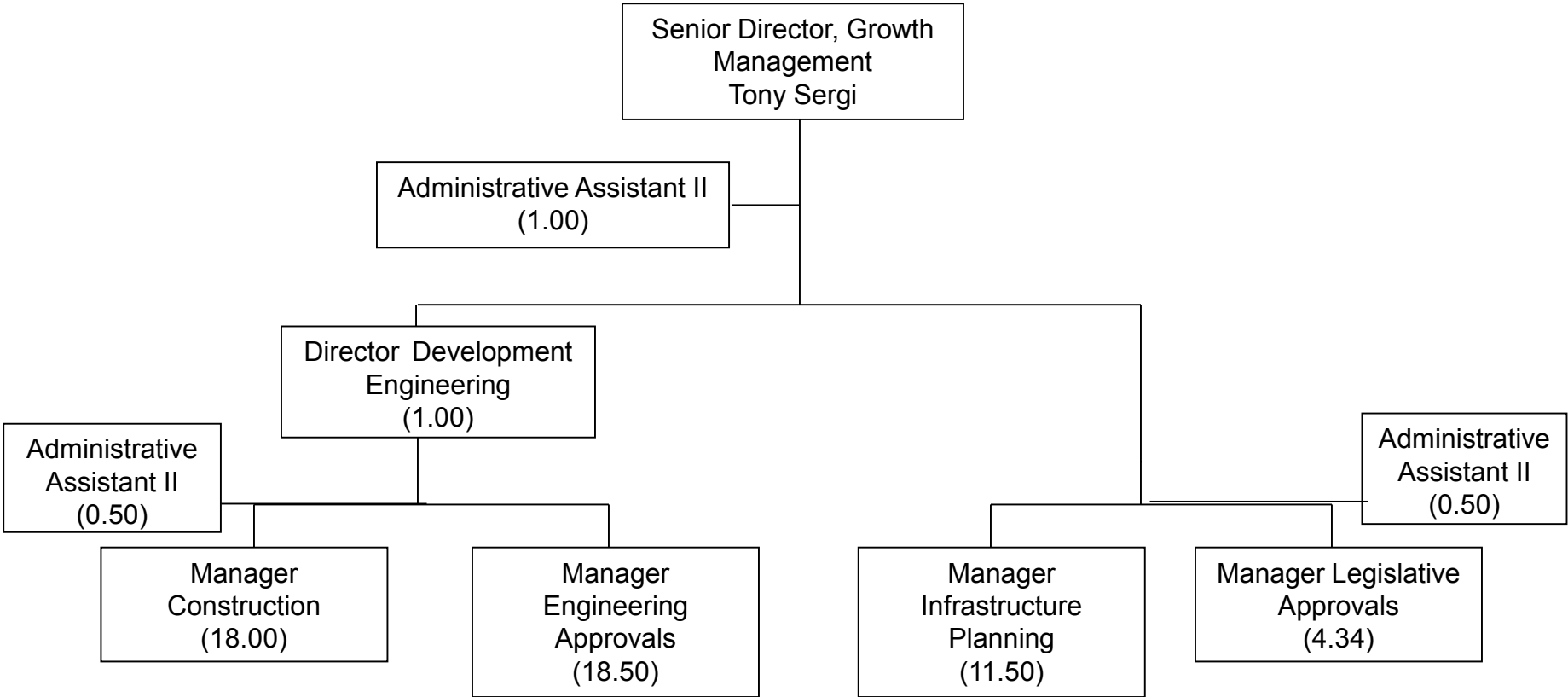

Complement (FTE)	Management	Other	Total	Staff to Management Ratio
2019	6.00	50.34	56.34	8.39:1
2020	6.00	50.34	56.34	8.39:1
Change	0.00	0.00	0.00	

2020 Operating Budget by Section

	2019	2020	2020	\$	%
	Restated	Preliminary	Preliminary		
	Net	Gross	Net		
Infrastructure Planning	1,107,150	2,321,180	1,242,710	135,560	12.2%
Grading & Construction Services	65,920	745,200	130,230	64,310	97.6%
Growth Management	(767,830)	3,753,360	(782,120)	(14,290)	1.9%
Total Growth Management	405,240	6,819,740	590,820	185,580	45.8%

2020 PRELIMINARY TAX OPERATING BUDGET

Licensing & By-Law Services

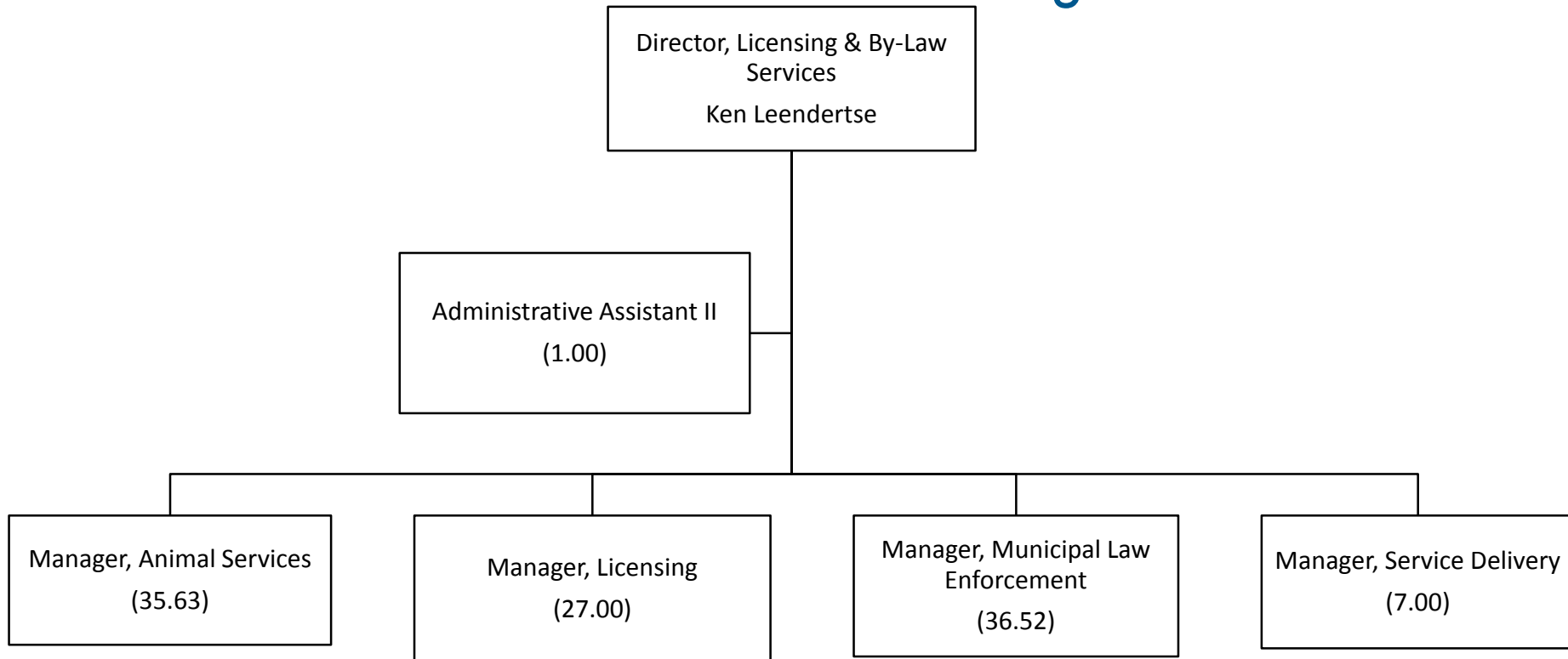

Complement (FTE)	Management	Other	Total	Staff to Management Ratio
2019	5.00	105.15	110.15	21.03:1
2020	5.00	103.15	108.15	20.63:1
Change	0.00	(2.00)	(2.00)	

2020 Operating Budget by Section

	2019	2020	2020	\$	%
	Restated	Preliminary	Preliminary		
	Net	Gross	Net		
Service Delivery	651,400	655,280	655,280	3,880	0.6%
Animal Services	2,765,330	4,392,930	2,851,930	86,600	3.1%
Directors Office L&BL	593,710	604,410	604,410	10,700	1.8%
Licensing	(315,680)	2,894,810	(594,180)	(278,500)	88.2%
Municipal Law Enforcement	2,920,850	4,122,830	3,128,510	207,660	7.1%
Total Licensing & By-Law Services	6,615,610	12,670,260	6,645,950	30,340	0.5%

2020 PRELIMINARY TAX OPERATING BUDGET

LRT Office

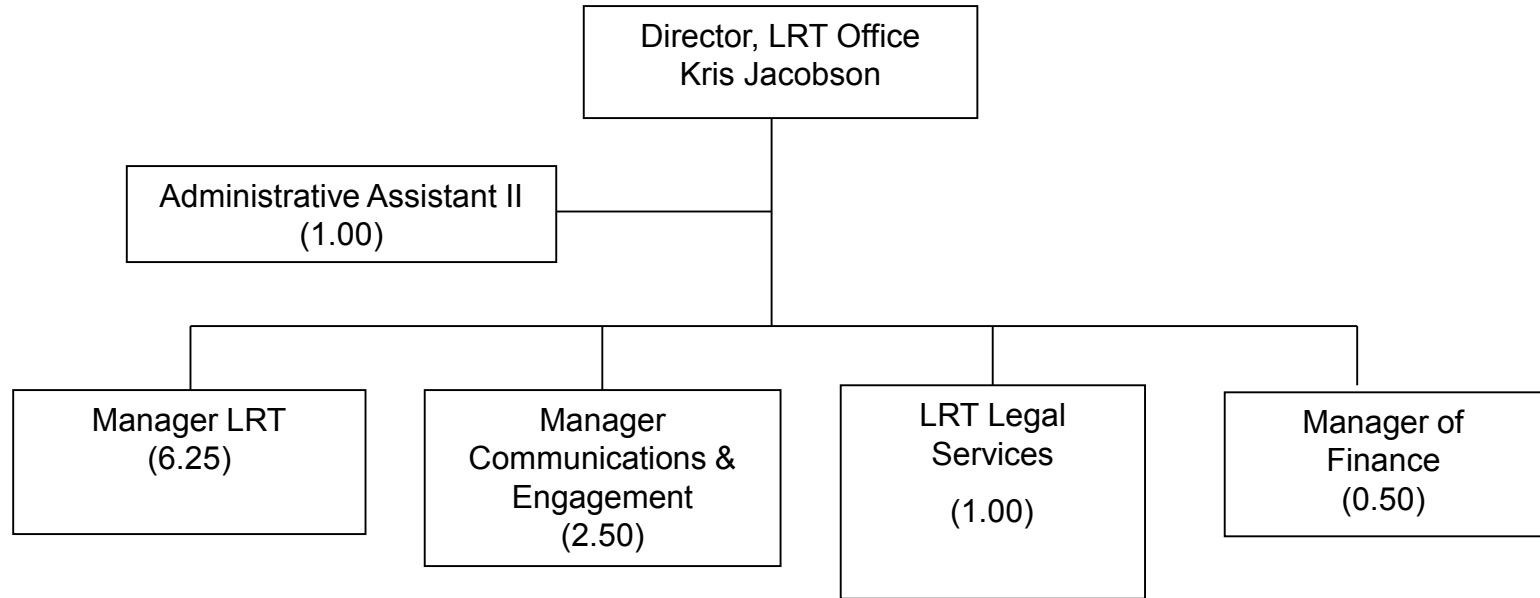

Complement (FTE)	Management	Other	Total	Staff to Management Ratio
2019	3.50	8.75	12.25	2.5:1
2020	3.50	8.75	12.25	2.5:1
Change	0.00	0.00	0.00	

2020 Operating Budget by Section

	2019 Restated Net	2020 Preliminary Gross	2020 Preliminary Net	\$	%
LRT Office	0	9,196,740	0	0	0.0%
Total LRT Office	0	9,196,740	0	0	0.0%

2020 PRELIMINARY TAX OPERATING BUDGET

Planning

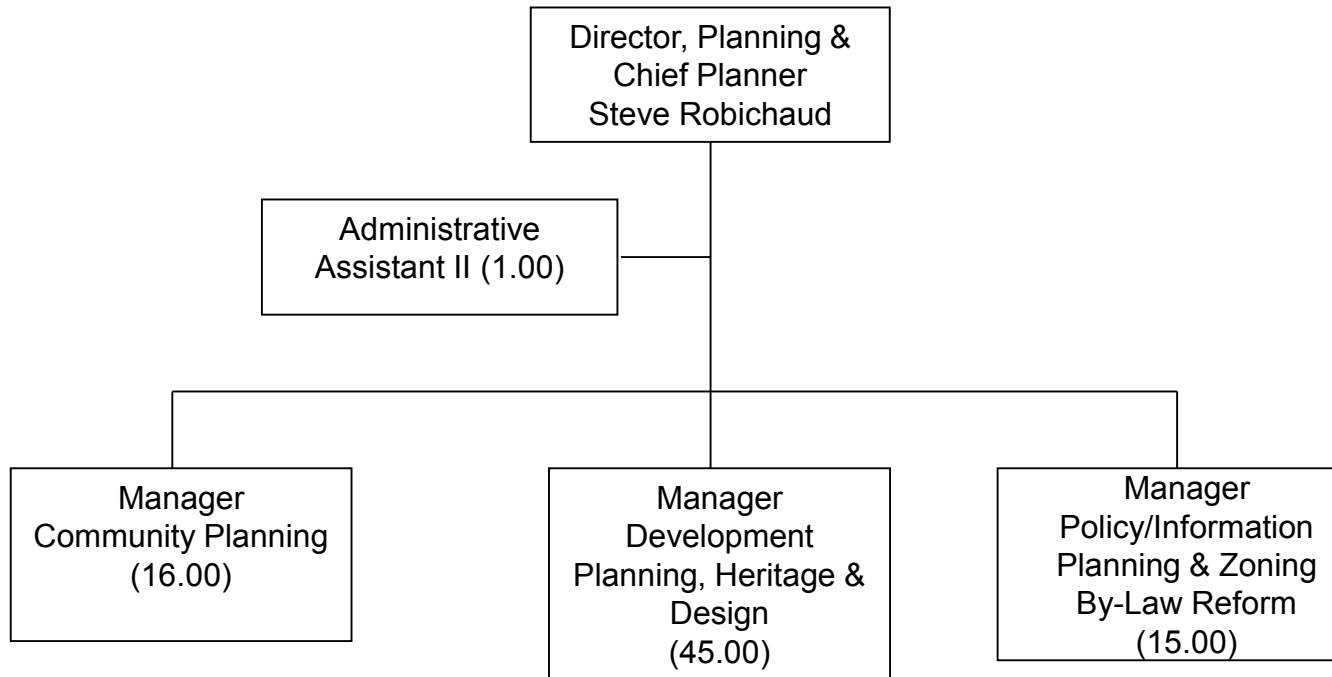

Complement (FTE)	Management	Other	Total	Staff to Management Ratio
2019	4.00	74.00	78.00	18.5:1
2020	4.00	74.00	78.00	18.5:1
Change	0.00	0.00	0.00	

2020 Operating Budget by Section

	2019	2020	2020	\$	%
	Restated	Preliminary	Preliminary		
	Net	Gross	Net		
Community Planning	1,732,660	1,752,380	1,748,380	15,720	0.9%
Planning & Committee of Adjmt	1,388,560	5,663,150	1,744,940	356,380	25.7%
Policy Planning, Zoning & Data	247,250	1,561,620	248,950	1,700	0.7%
Total Planning	3,368,470	8,977,150	3,742,270	373,800	11.1%

2020 PRELIMINARY TAX OPERATING BUDGET

Tourism & Culture

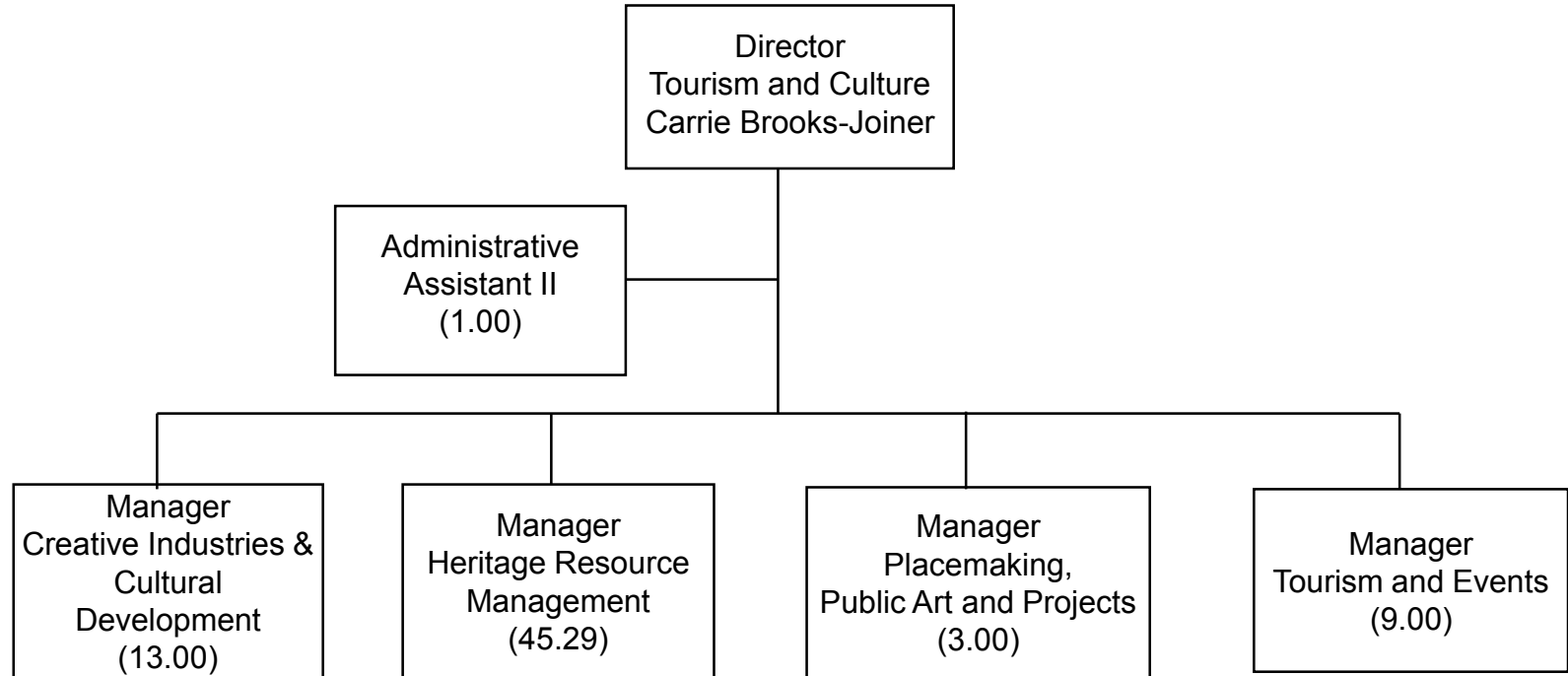

Complement (FTE)	Management	Other	Total	Staff to Management Ratio
2019	5.00	67.29	72.29	13.46:1
2020	5.00	67.29	72.29	13.46:1
Change	0.00	0.00	0.00	

2020 Operating Budget by Section

	2019 Restated Net	2020 Preliminary Gross	2020 Preliminary Net	\$	%
Place Making, Public Arts and Projects	638,560	671,870	661,570	23,010	3.6%
Creative Industries and Cultural Development	1,712,830	1,809,760	1,730,290	17,460	1.0%
Heritage Resource Management	4,677,120	5,886,770	4,704,890	27,770	0.6%
Tourism	1,419,570	1,540,990	1,414,630	(4,940)	(0.3%)
Directors Office Tourism & Culture	693,180	708,160	708,160	14,980	2.2%
Total Tourism & Culture	9,141,260	10,617,550	9,219,540	78,280	0.9%

2020 PRELIMINARY TAX OPERATING BUDGET

Transportation Planning & Parking

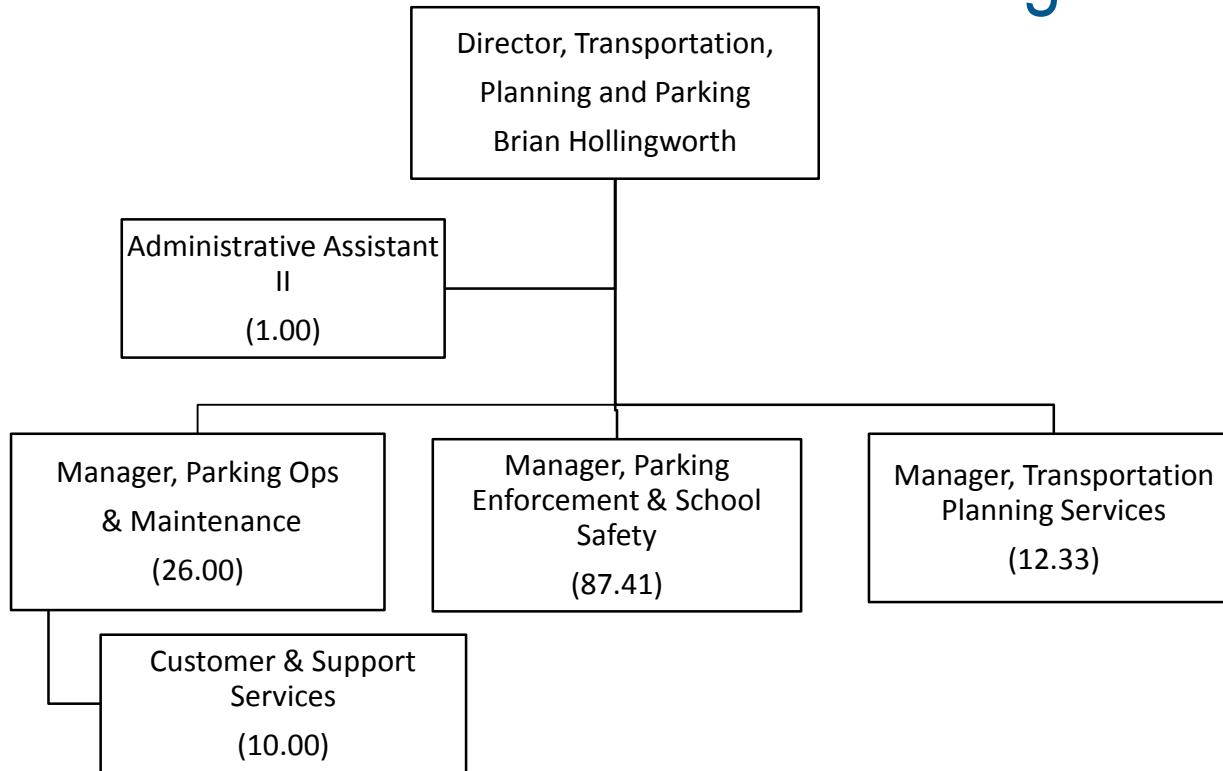

Complement (FTE)	Management	Other	Total	Staff to Management Ratio
2019	4.00	132.74	136.74	33.19:1
2020	4.00	133.74	137.74	33.44:1
Change	0.00	1.00	1.00	

2020 Operating Budget by Section

	2019 Restated Net	2020 Preliminary Gross	2020 Preliminary Net	\$	%
Transportation Planning	1,548,730	1,667,220	1,164,000	(384,730)	(24.8%)
Director's Office TPP	138,610	159,750	159,750	21,140	15.3%
Hamilton Municipal Parking System	(1,294,970)	12,908,010	(775,380)	519,590	(40.1%)
School Crossing	1,755,650	1,895,340	1,895,340	139,690	8.0%
Total Transportation, Planning and Parking	2,148,020	16,630,320	2,443,710	295,690	13.8%

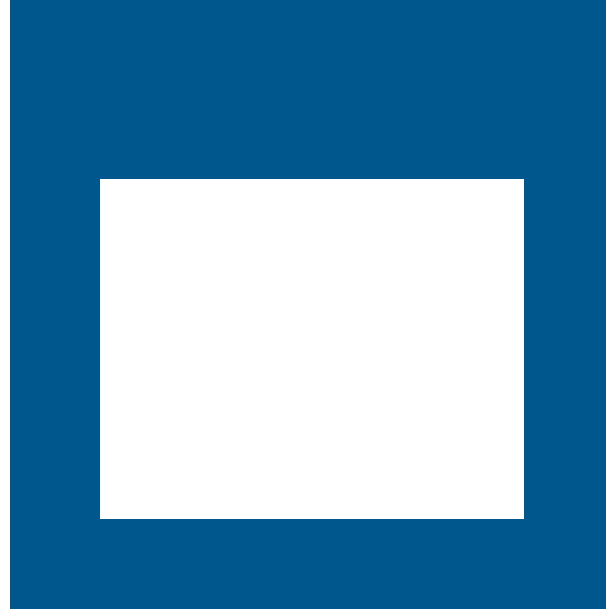

THANK YOU