



City of Hamilton

ADVISORY COMMITTEE FOR PERSONS WITH DISABILITIES ADDENDUM

Meeting #: 22-007
Date: June 14, 2022
Time: 4:00 p.m.
Location: Room 264, 2nd Floor, City Hall
(hybrid) (RM)
71 Main Street West

Carrie McIntosh, Legislative Coordinator (905) 546-2424 ext.2729

Pages

7. CONSENT ITEMS

7.6. Accessible Open Spaces and Parklands Working Group

- *b. Accessible Open Spaces and Parklands Working Group Meeting Notes - May 25, 2022 3

8. PRESENTATIONS

- *8.3. Presentation by Andrea McDonald, Senior Project Works Manager, Public Works respecting the Location of a Wheelchair Swing in William Connell Park 7

OSPWG Notes
Wednesday, May 25, 2022
1:30 – 3:30 p.m.

Welcome and introductions

Present: Meghan, Paula, Mark, Aznive, Kim and Tim
Regrets: Tom
Absent: James

Welcome to Paula

Review and follow up from April 28, 2022 meeting

All good

Updates from May 24, 2022 ACPD meeting

No comments

Sidewalk dining tour with Rob Lalley May 26, 2022 11:00
a.m.

Invite to ACPD members to be sent via Carrie. Tour was mentioned to all ACPD members at the May 24, 2022 meeting. Purpose is to look at some dining sites along the

James St. North corridor re: accessibility to dining and sidewalk obstruction.

Discussions with consultant on outdoor dining guidelines

Tim spoke recently with Thea (company name?) re: information on their website re: outdoor dining accessibility. The website is often used as reference by municipalities. Thea agreed that the information on the site can be reviewed for update. Tim to send link to WG folks. Consultant agreed to update the site with input. Any input welcome from all.

Info re: outdoor dining

The brochure approved by ACPD and to be designed by Outreach should include general info and referral to ACPD. Photo on the front: Barrier to person with a disability photo. Consult with ACPD.

List of to do things or things to think about – minimums

Spreadsheet of Parklands and Open Spaces Structures

Led to discussion of swing surfaces underneath. Meghan indicated rubber surface is a good alternative to wood chips/mulch. Materials must consider for risk of injury in case of accident. In Many instances a combination of rubber and mulch/wood chips are used. Cost is an issue to

use the rubber surface. Parks can be selected on a case by case basis.

Led to discussion about consultation with ACPD on design and development including new and retrofit parks

Spreadsheet

Meghan will take a first attempt to populate the spreadsheet. All agreed that the design of the spreadsheet was acceptable to start.

Meghan has been speaking with Carrie about authority to make regulations. City has made barrier free design guidelines which may be the only option going forward. By regulation staff must comply first with code and AODA. May be a matter of language choice (regulation versus guideline) to create accessible spaces. In many instances park folks try to exceed code (e.g. 5% slope) but at times they can only meet code (8% slope).

Spreadsheet is okay by all and Meghan has already started to pull it together. Meghan will also work on it over the next couple weeks including populating the list

GAATES guidelines discussion

Lots of information there. Hope folks can take a look before next meeting. A lot of items for the spreadsheet will come from the GAATES document.

Other Business

Discussion about some items for accessible design such as distance between benches and picnic tables. All these things should make their way into a new document.

OT student

The idea of an OT student assisting with this work under the direct supervision of staff is a good one. Tim to reach out and feed back info to staff at the next meeting.

Next meeting June 22, 2022 1:30 – 3:30 p.m.



Hamilton

WHEELCHAIR ACCESSIBLE SWING PROPOSAL

May 2022

- Introductions
- Purpose of a Wheelchair Accessible Swing
- Previously Installed Wheelchair Accessible Swing in Hamilton
- Overview of our current project(s)
- Possible locations for the Wheelchair Accessible Swings
- Thoughts and Discussion
- Questions & Comments



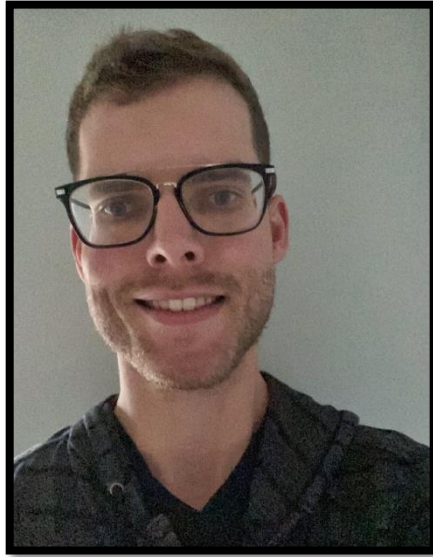

Kevin Kernaghan
Project Manager – Capital
Parks and Cemeteries



Andrea McDonald
Senior Project Manager – Capital
Parks and Cemeteries



Purpose of a Wheelchair Accessible Swing

- Opportunities for all – both children and their friends/caregivers
- Social Interaction – using teamwork to move the swing
- Exercise – working to move the swing results in muscle engagement, balance stabilization
- Inclusive Placement – the swing is ideally installed within the overall play area



Hamilton's Wheelchair Accessible Swing Pilot Project

- Hamilton started a pilot project by installing a wheelchair accessible swing at Gage Park

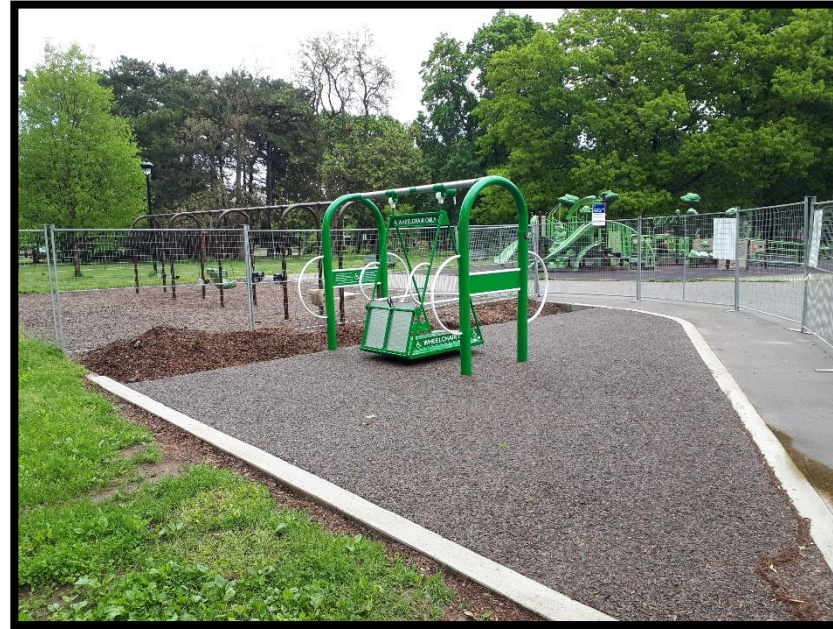

Project Overview

- Supply and install Wheelchair Accessible Swings at two park locations
- Heritage Green Sports Park (355 First Road West)
- William Connell Park (1086 West 5th Street)



We-Go Swing by ABC Recreation



We-Go Swing by ABC Recreation



We-Go Swing by ABC Recreation

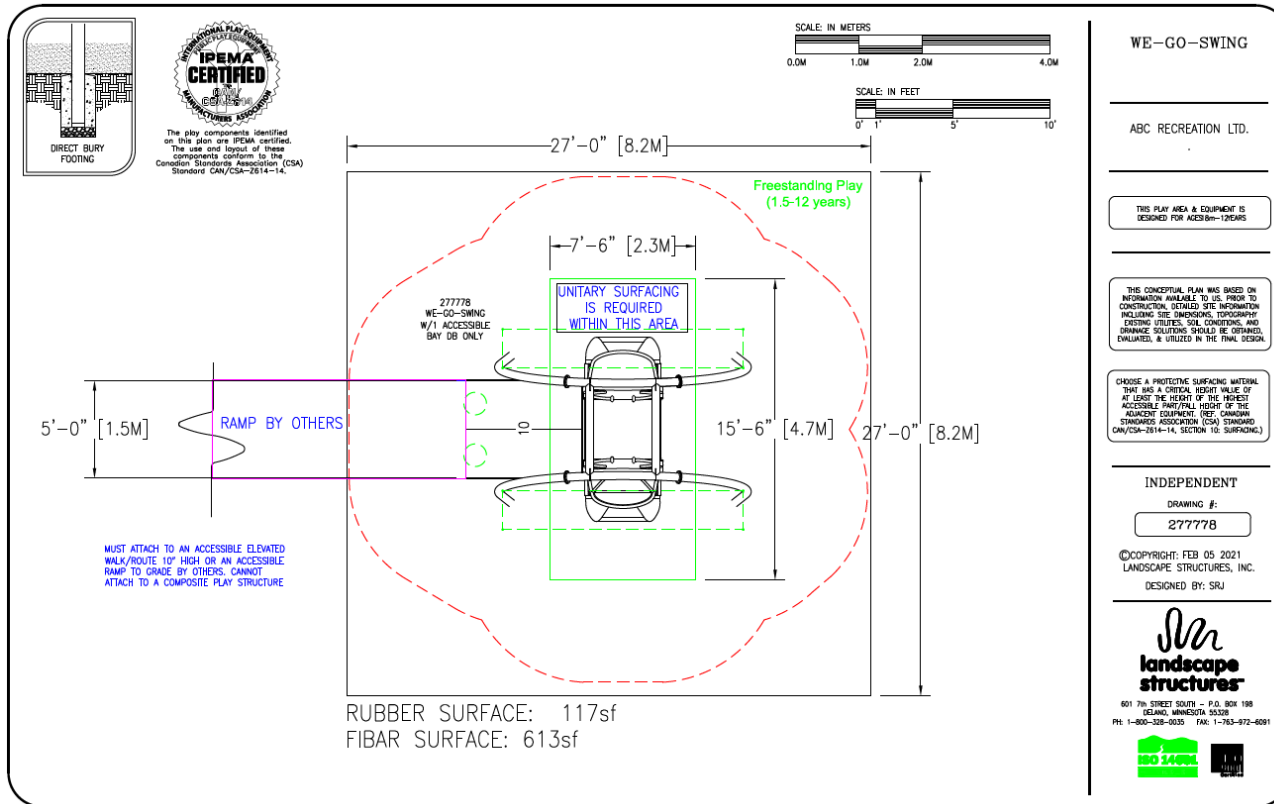

Heritage Green Sports Park – 355 First Road West

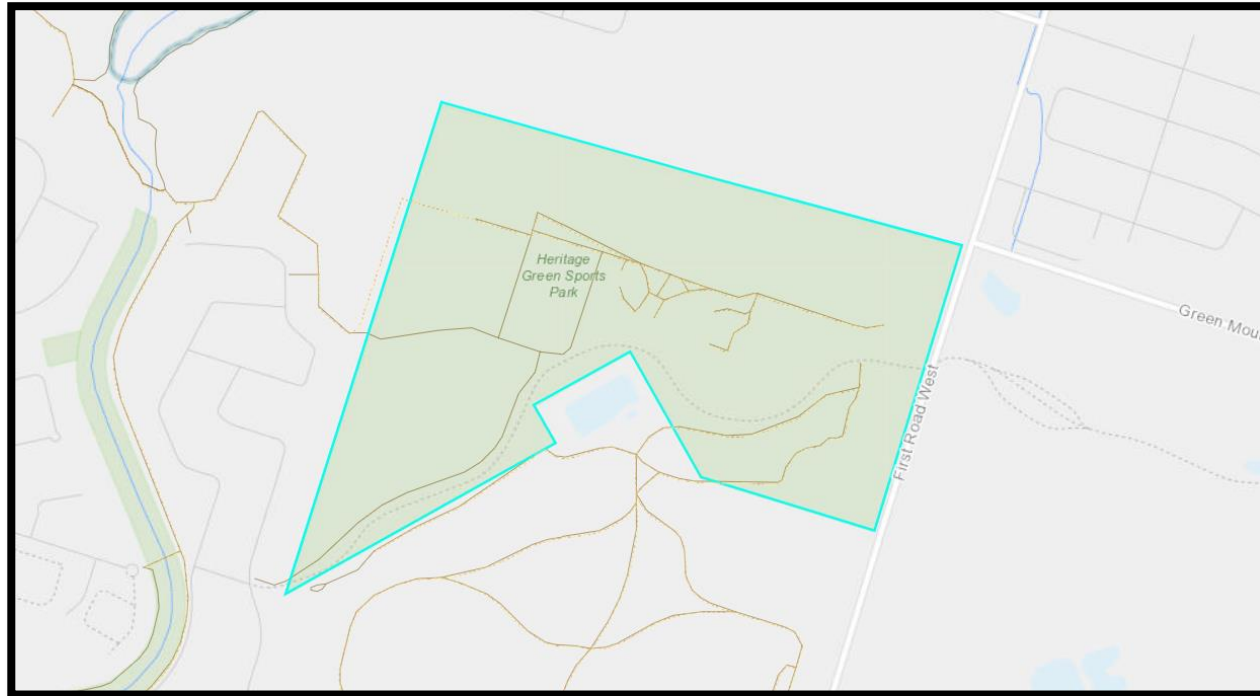

Heritage Green Sports Park – 355 First Road West

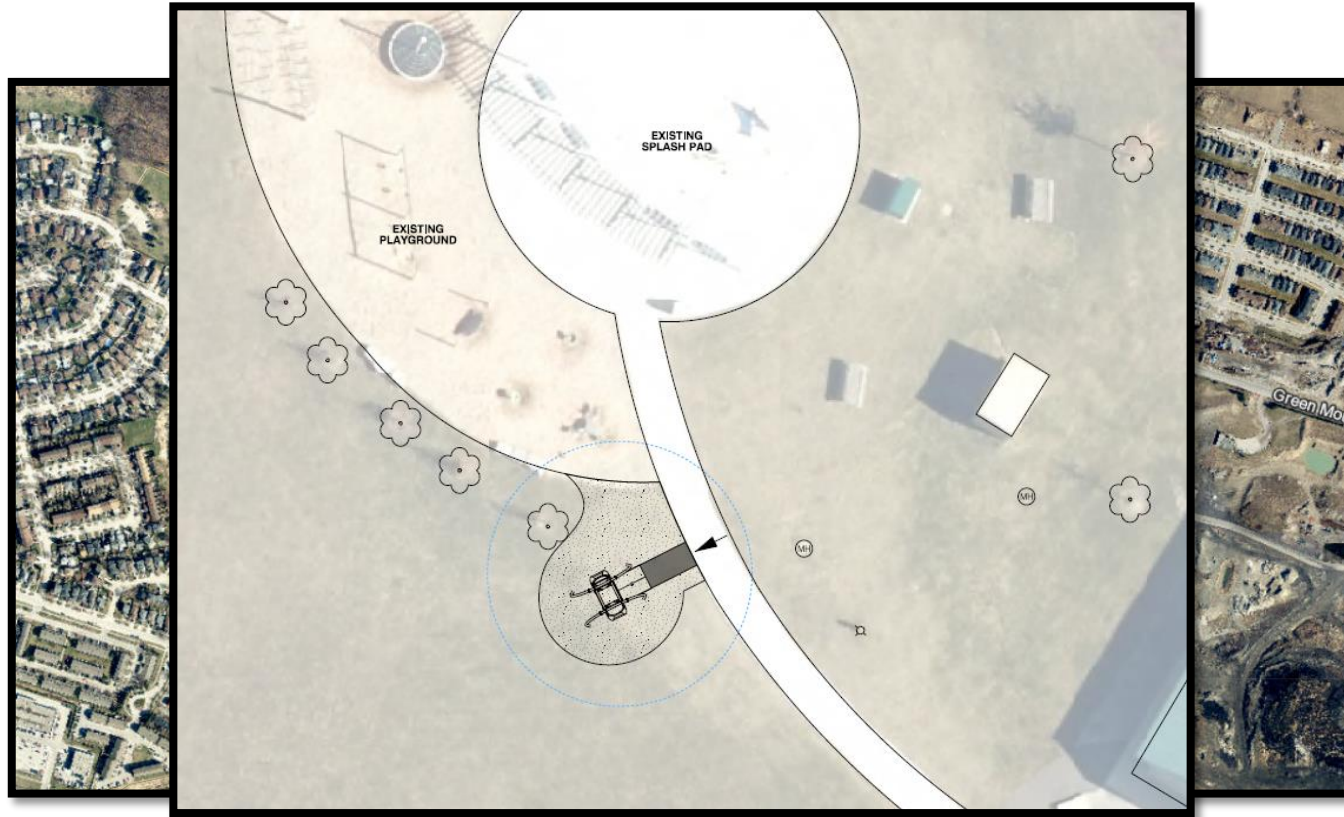

Heritage Green Sports Park – 355 First Road West



William Connell Park – 1086 West 5th Street

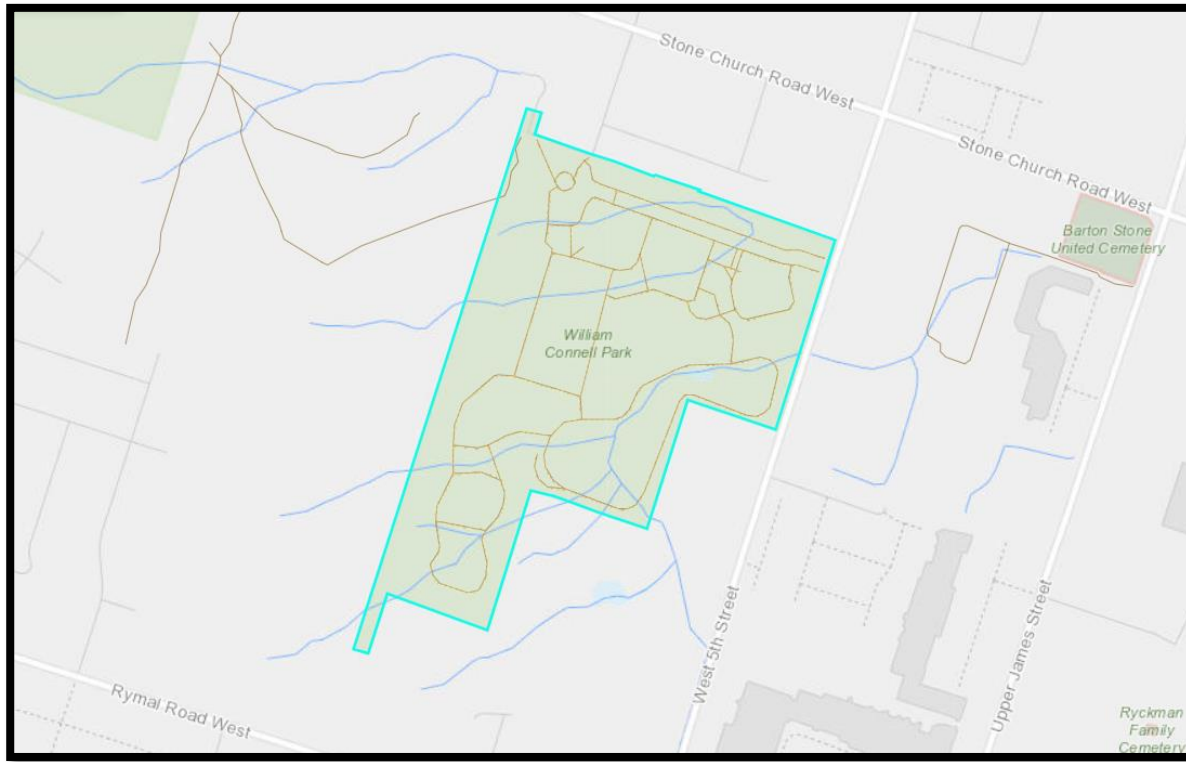

William Connell Park – Swing Location Option 1

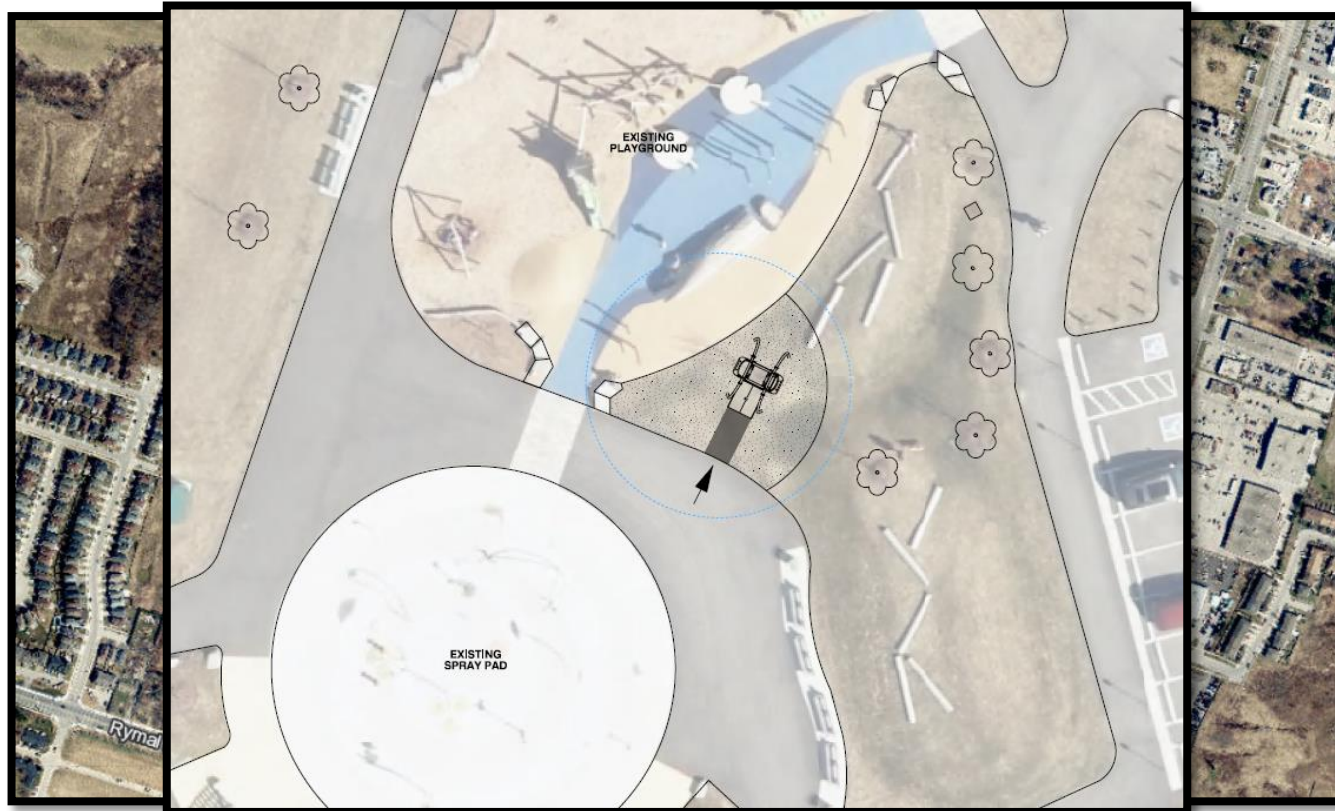

William Connell Park – Swing Location Option 1



William Connell Park – Swing Location Option 2



William Connell Park – Swing Location Option 2



Thoughts & Discussion



Questions / Comments?

