



Hamilton

PRELIMINARY



2022 TAX SUPPORTED OPERATING BUDGET **REPORT**

CONTENT

1	2022 BUDGET SUMMARY REPORT
	APPENDICES
23	1 Net Levy Summary
31	2 Gross and Net Expenditure Summary
39	3 Cost Category Summary
43	4 Complement Summary
49	5 Departmental Budget Summaries
159	6 Council Referred Items
173	7 Business Cases
199	8 Multi-Year Outlook

2022 TAX OPERATING BUDGET OVERVIEW

The City of Hamilton’s 2022 Preliminary Tax Supported Operating Budget is proposed at \$997M, representing an increase in the net tax levy of 4.5% or \$43M, which translates to an estimated average residential property tax increase of 3.3% or \$136 for the average residential property assessed at \$381,000. In setting the net tax levy, the City first considers all other revenue sources available to the municipality, such as user fees and subsidies from senior levels of government, and levies the remaining funds required to deliver services at a balanced budget in accordance with The Municipal Act, 2001.

The net levy increase of \$43M, or 4.5%, is the estimated cost required to continue service delivery for City Departments, Boards & Agencies and delivery of the 2022 Tax Supported Capital Budget, as well as to advance strategic priorities that were previously approved in 2021. An estimated assessment growth benefit of (1.0%), property class levy restrictions of 0.1%, estimated Education benefit of (0.3%) and no reassessment impact for 2022 reduces the initial levy increase of 4.5% to a total estimated average residential tax impact of 3.3%.

2022 MUNICIPAL PRELIMINARY TAX IMPACT FOR THE AVERAGE RESIDENTIAL PROPERTY TAX BILL

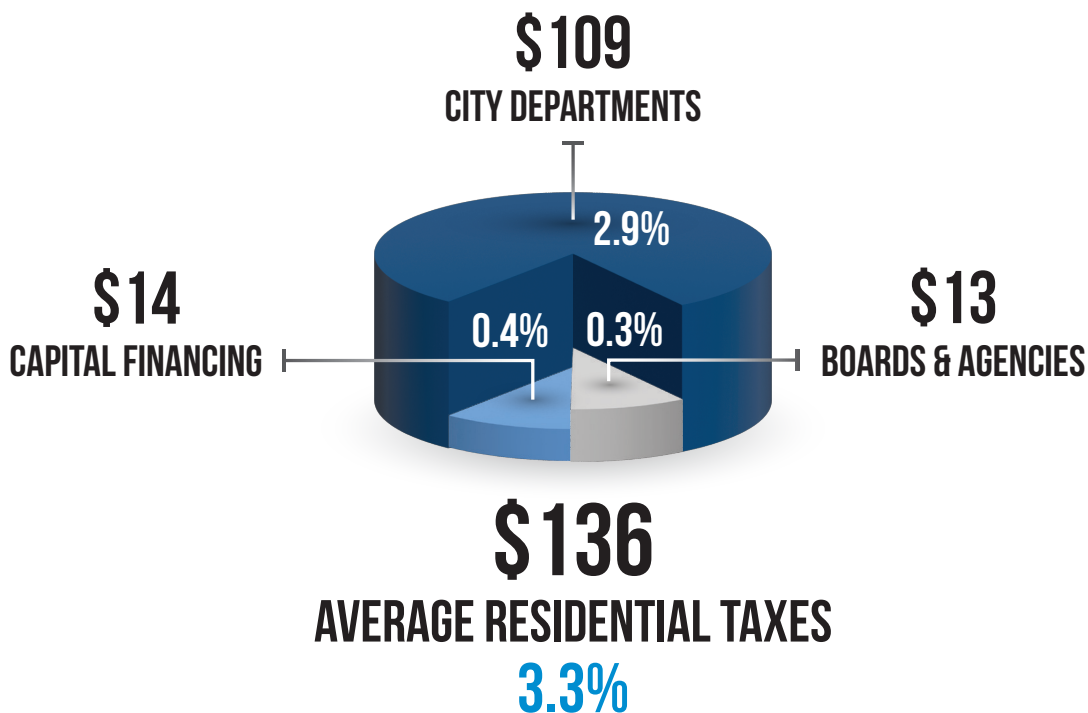

- Anomalies due to rounding
- Assumes (1.0%) benefit for growth and no reassessment impact
- Average residential assessment: \$381,000
- Assumes (0.3%) benefit for Education impact

The 2022 Preliminary Tax Supported Operating Budget would result in an average residential tax impact of approximately 3.3%, which is required to support the delivery of all City provided services, the City's Strategic Plan and the City's vision to be the best place to raise a child and age successfully. The recommended levy increase includes inflation and non-discretionary contractual increases required to maintain services at current levels, as well as strategic investments and service continuity for services that continue to be affected by changes in Provincial Funding Agreements:

- **Multi-Modal Transportation, Equity Diversity & Inclusion (EDI) and Climate Change:** The 2022 budget includes significant investment in Transit Services to support Council's multi-modal transportation strategic goals and the implementation of year six of the 10-Year Local Transit Strategy. Council approved enhancements to the level of service for sidewalk snow removal along bus routes on April 28, 2021 through Report PW19022(c) to promote equitable access to public transit. In addition to working towards the multi-modal transportation and EDI goals, these investments help to support the City's climate action goals and move towards a net zero municipality.
- **Affordable Housing and Homelessness:** Strategic investments for 2022 include additional contributions to the Rent Remy Program, loan repayments for the Canadian Mortgage Housing Corporation National Housing Strategy Co-Investment Fund, continuation of the Roxborough Housing Incentive Program (RHIPP) and ensuring continuity of service by providing the required increases in benchmark funding and replacing decreased revenues from Federal subsidy. As detailed in Report HSC20020(d), the City of Hamilton is committed to continue building on COVID-19 emergency supports to a more responsive, resilient, sustainable and housing-focused homeless serving system. The expenses for the operation of isolation services, drop-ins and hotel rooms for expanded temporary sheltering have been included in the 2022 Preliminary Budget with dedicated funding up to March 31, 2022.

- **Fiscal Health and Financial Management:** A key priority of the annual budget process is to ensure appropriate and financially sustainable investment in asset replacement to ensure infrastructure is maintained in a state-of-good-repair. The 2022 Preliminary Budget includes a net levy increase of 0.5% (\$4.8M) dedicated to asset renewal to support sound stewardship of existing assets by providing sufficient funding to maintain the desired condition and service levels of critical infrastructure. Additionally, through the 2022 Tax Supported Capital Budget deliberations, Council approved a 0.15% net levy increase for debt servicing requirements related to the Investing in Canada Infrastructure Program – Transit Stream and West Harbour strategic initiatives. It is important to increase the capital levy in direct proportion to the increase in debt servicing requirements at a minimum in order to maintain the ratio between City own source revenues and annual debt obligations so that the City’s AA+ credit rating is maintained.
- **Provincial Funding:** Changes in Provincial Funding Agreements continues to represent a significant budget pressure for 2022. The funding for mandatory programs and the mitigation funding received is based on 2018 expenses. Even with the one-time mitigation funding for Public Health in 2022, the Ministry of Health funding will only be approximately 70% of total costs as a result of cost increases since 2018. In 2022, the transition funding for Children’s Services comes to an end, as well as the long-standing High Wage Transition Funding for Long-Term Care and the Household Hazardous Waste Program. In order to ensure service continuity, the City of Hamilton has absorbed the \$2.6M of lost annual funding for these programs.

The COVID-19 pandemic response will continue to have many financial pressures on City services in 2022 including the loss of revenue from transit operations and recreation user fees, as well as, increased costs for Public Health response and vaccination programs and emergency shelters for housing the community’s most vulnerable. The City has some capacity to fund the forecasted pressures through previous funding announcements from senior levels of government and eligibility to carry funds into 2022. However, there have been no announcements related to continued funding to address pressures specifically related to 2022 operations and the City’s forecast currently exceeds total funding available.

In development of the 2022 Preliminary Tax Operating Budget, staff have assumed that all pressures related to COVID-19 will be funded from senior levels of government. It is essential that the City continue to pursue advocacy efforts with other municipal partners for relief funding and potential economic stimulus funding programs to address the shortfall.

Property taxes support City Services, as well as Provincially Funded Programs, such as Public Health and Ontario Works, Boards and Agencies, such as the Hamilton Police Service and Conservation Authorities, and Education. City Services make up approximately 55% of the total property tax bill. Tax supported City Services are largely comprised of roads, sidewalks and streetlighting operations and maintenance, waste management services, parks operations and maintenance, fire services, transit services and recreation services.

An average residential tax impact of 3.3% is required to maintain current levels of service including pre-approved and legislated service level impacts. City Council has the legislated authority over approximately 55% of the total budget. Provincially Funded Programs, Boards and Agencies and Education are either governed by authorities other than City Council or are supported through Funding Agreements that limit City Council’s ability to affect the overall tax rate by changes to these programs. Therefore, in order to maintain the current 2021 tax rate, City Services would require service level reductions of 5.8% to mitigate the estimated 3.3% overall tax impact.

2022 PROPERTY TAX BREAKDOWN

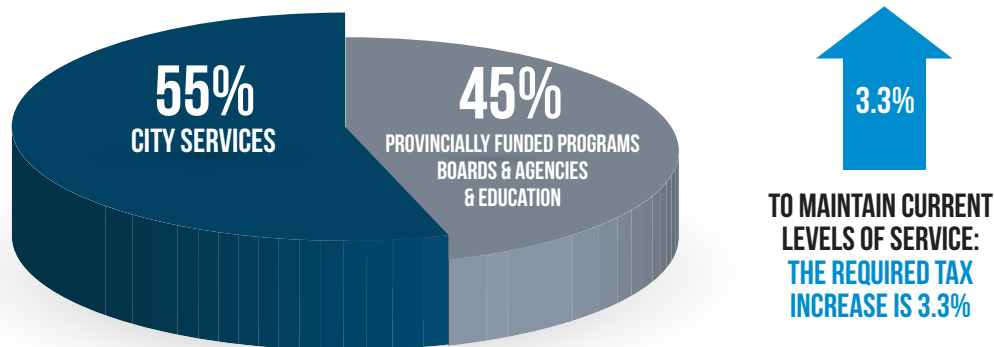

0%
TO MAINTAIN 2021 TAX LEVY:
CITY COUNCIL HAS FULL CONTROL TO
REDUCE OR ADJUST SERVICE LEVELS
THAT MAKE UP 55% OF THE TAX LEVY

5.8%
5.8% SERVICE LEVEL
REDUCTION IN CITY SERVICES:
IS REQUIRED TO MAINTAIN THE
CURRENT TAX RATE

CITY SERVICES



ROADS, SIDEWALKS
AND STREETLIGHTING



WASTE MANAGEMENT



PARKS



FIRE SERVICES



TRANSIT



RECREATION



PLANNING AND ECONOMIC
DEVELOPMENT

2022 TAX SUPPORTED OPERATING BUDGET

BUDGET PROCESS

The 2022 Preliminary Tax Supported Operating Budget is a collaborative process undertaken by City staff throughout 2021. The Tax Supported Operating Budget is one component of the City's overall annual budget and supports the delivery of all the City's services with the exception of Water, Wastewater and Stormwater services, which are supported through rate revenues. Both the tax and rate supported service groups have infrastructure and facility requirements that are funded by their respective capital budgets. The 2022 Rate Supported Operating and Capital Budget and the 2022 Tax Supported Capital Budget were submitted separately for Council's consideration on November 22, 2021 and November 26, 2021 respectively. The 2022 Tax Supported User Fees were submitted for Council's consideration on December 8, 2021.

The 2022 Preliminary Tax Supported Operating Budget overview will be presented to the General Issues Committee (GIC) on January 14, 2022 and the Departmental presentations will begin on January 25, 2022. The deliberation process and final budget approval is expected to be completed by late March 2022.

City Council amended the budget directions in deliberation of the 2022 Budget Guidelines, Outlook and Process Report FCS21057(a) with the following recommendations:

- a. That City Departments be directed to prepare the 2022 Tax Operating Budget at an increase required to maintain current service levels with a 2% guideline and report back through the 2022 budget process;
- b. That staff be directed to increase user fees at the rate of inflation and that any user fee increases below the guideline be forwarded for consideration with appropriate explanation;

- c. That Boards and Agencies be directed to prepare their 2022 Tax Operating Budget submissions at an increase required to maintain current service levels with a 2% guideline and that any increase beyond the guideline be forwarded for consideration with appropriate explanation;
- d. That staff be directed to prepare the 2022 Tax Capital Budget with a 0.6% municipal tax levy increase for capital financing of discretionary block funded projects and debt servicing requirements for the Investing in Canada Infrastructure Program – Transit Stream and West Harbour Redevelopment strategic initiatives;
- e. That staff be directed to prepare the 2022 Rate Supported Budget at a rate increase required to maintain current service levels and priority infrastructure;
- f. That the Mayor provide correspondence to the local MPs and MPPs thanking senior levels of government for past and continued support in navigating through the COVID-19 pandemic; and,
- g. That staff be directed to enhance the public delegation opportunity to the 2022 Budget by adding a date between Feb 10th to March 3rd, 2022.

The 2022 Preliminary Tax Operating Budget was prepared in consideration of this direction while also balancing requirements with the following principles:

COUNCIL REFERRED ITEMS

Items that Council has referred by motion or through the approval of staff recommendations to the 2022 Tax Supported Operating Budget process will be vetted at GIC through deliberations in February 2022. There are currently no Council Referred Items included in the preliminary budget totals – these items are included in Appendix 6 “Council Referred Items”.

BUSINESS CASES

Business Cases can be found in Appendix 7 “Business Cases”. The proposal of new revenue, request for additional resources to deliver services or any recommended changes to staffing levels are summarized in business cases for Council’s consideration. These items are not included in the preliminary budget totals.

MULTI-YEAR BUDGETS

Multi-Year budgeting strengthens the link between budgeting and strategic priorities and enables Council to implement a multi-year vision, assessing the long-term financial implications of current and proposed Operating and Capital Budgets, budget policies, investment policies, tax policies and assumptions.

A three-year outlook for 2023-2025 is summarized in Appendix 8 “Multi-Year Outlook” for the City. Three-year outlooks for 2023-2025 will also be presented by the General Managers during their departmental budget presentations. Making the multi-year budgets more prominent will assist towards approval in principle of these budgets in the upcoming years.

BUSINESS PLANS

Multi-year business planning serves as a roadmap for municipalities to ensure Council’s priorities, as outlined in the City’s Strategic Plan, are converted into action. Each City department prepares multi-year business plans to identify and align departmental and divisional initiatives to the City’s vision “to be the best place to raise a child and age successfully,” with the Strategic Plan front and centre. The City does not have the financial resources or the organizational capacity to do everything at once. By establishing our priorities, creating achievable initiatives, and tracking progress with meaningful performance measurement, the City will realize its mission of providing high quality, cost conscious public service that contributes to a healthy, safe and prosperous community.

Departmental and divisional initiatives are communicated during the departmental budget presentations as well as summarized in the Corporate Plan. The Corporate Plan is issued upon approval of all three budgets: Rate Supported Operating and Capital, Tax Supported Capital and Tax Supported Operating.

2022 CONSOLIDATED BUDGET

Table 1 highlights the consolidated gross expenditure preliminary budgets for the City combining Tax and Rate supported services:

Table 1

2022 Preliminary Consolidated City Budget			
Gross Expenditures			
(\$000's)	Rate	Tax	Total
Operating	257,851	1,473,384	1,731,235
Capital	310,436	386,102	696,538
Total	568,287	1,859,485	2,427,772
Note: Does not include Council Referred Items or Business Cases			

This document provides detailed information in respect of the 2022 Preliminary Tax Supported Operating Budget. As mentioned, the 2022 Rate Supported Operating and Capital Budget and the 2022 Tax Supported Capital Budget were submitted separately for Council’s consideration on November 22, 2021 and November 26, 2021 respectively.

During the 2021 Tax Supported Operating Budget process, staff prepared a 2022 - 2024 Multi-year Outlook based on assumptions and known increases. The initial Outlook for 2022 was a projected levy increase of \$37.7M and a 3.4% tax increase. Based on updated information, the initial projection has been revised to a levy increase of \$42.9M and a 3.3% tax increase. The 2022 Preliminary Tax Supported Operating Budget, as submitted, does not include any measures that would adversely impact programs and services.

2022 PRELIMINARY TAX SUPPORTED OPERATING BUDGET - TAX IMPACT

The submitted 2022 Preliminary Tax Supported Operating Budget requires a levy increase of \$42.9M. This increase would result in an estimated average residential tax increase of 3.3% or \$136 for the average residential home assessed at \$381,000.

Table 2 highlights the tax increase by major component:

Table 2

2022 Average Residential Tax Impact				
(Per \$381,000 Current Value Assessment)				
	2021	2022	\$	%
Municipal Taxes				
City Departments	\$ 2,527	\$ 2,636	\$ 109	2.9%
Boards & Agencies	\$ 875	\$ 888	\$ 13	0.3%
Capital Financing	\$ 373	\$ 387	\$ 14	0.4%
Municipal Taxes	\$ 3,775	\$ 3,911	\$ 136	3.6%
Education Impact				(0.3%)
Total Average Residential Tax Impact				3.3%

Notes:

- 1) Anomalies due to rounding
- 2) Assumes growth benefit of (1.0%). The final tax roll from MPAC will be confirmed in February 2022
- 3) Assumes 0% for 2022 reassessment as announced by the Province
- 4) Assumes no Tax Policy impacts for Small Business subclass in 2022
- 5) Assumes levy restriction impact of 0.01% based on historical trends
- 6) Assumes 0.3% benefit for Education based on historical trends. The final education impact will be confirmed in February 2022

As indicated in Table 2, the tax impact attributable to City departments is about 2.9%. The Boards and Agencies tax impact is 0.3%, subject to any changes that may occur through the deliberation of the budgets submitted by the various Boards and Agencies. Currently, the budgets for Boards and Agencies assume a 2.0% net levy increase, with the exception of Hamilton Public Library, Hamilton Farmer's Market and the City Enrichment Fund which have been included at their respective budget submissions, in line with the Council directed target approved on October 13, 2021. An increase of 0.65% to the Capital Levy has been included as approved through the 2022 Tax Supported Capital Budget deliberations and Report FCS21096 on December 15, 2021. Additional details can be found in the "Summary" section of the Report.

Also submitted are any applicable Council Referred Items and Business Cases to be considered during the budget process. If approved as submitted, the Council Referred Items and Business Cases will add 0.02% and 0.16% to the tax impact respectively, resulting in a total combined impact of 0.18%.

City of Hamilton residents in all communities pay the same rate for general City services, such as police, public health, roads, waste management, libraries, parks and City administration.

Area rating is a municipal property taxation policy tool intended to account for either significant differences in service levels or differences in the cost of providing services across different parts of the City (Municipal Act, 2001, Section 326).

The current area rating model has been in effect since it was approved in 2011. In order to ensure that the area rating methodology aligns with the projected growth and related service delivery strategies and to respond to specific Council direction (sidewalk snow removal), staff are conducting a review of the following area rated services:

- Fire;
- Sidewalk snow removal;
- Parkland purchases; and,
- Recreation.

Preliminary findings of the area rating review, proposed changes and options will be presented in January 2022. Final recommendations will be presented by mid-February / early March 2022 in order to be included in the total tax impact to be approved by Council as part of 2022 budget deliberations.

2022 PRELIMINARY TAX SUPPORTED OPERATING BUDGET - SUMMARY

The 2022 Preliminary Tax Supported Operating Budget identifies a levy requirement of \$997.4M, which represents an increase of \$42.9M, or 4.5%, over 2021. An estimated assessment growth benefit of (1.0%), no reassessment impact, property class restrictions of 0.1%, and an education benefit of (0.3%) reduce the projected average residential tax impact to 3.3%.

The 2022 Preliminary Tax Supported Budget is detailed in Table 3. The projected costs to maintain current service levels (Maintenance Budget) is \$15.5M for City departments or approximately 36% of the total projected net levy increase. The Maintenance Budget results in an average residential property tax increase of approximately 0.4%. Other strategic investments in the 2022 Preliminary Tax Supported Operating Budget total \$27.4M and account for the remainder of the estimated tax increase to arrive at the projected 3.3%. The majority of the budget pressures are comprised of enhancements and service level adjustments with significant planned and pre-approved investments in capital infrastructure, transit and housing. Additional detail on the 2022 Preliminary Tax Supported Budget is provided in Appendix 1 “Net Levy Summary”, Appendix 2 “Gross and Net Expenditures Summary” and Appendix 3 “Cost Category Summary”.

Table 3

(\$000's)	2021	2022			Change			
	Restated	Maintenance	Strategic Priorities	Preliminary	Maintenance vs. Restated		Preliminary vs. Restated	
City Departments	583,674	594,693	21,250	615,942	11,019	1.9%	32,268	5.5%
Boards & Agencies	231,203	235,733	-	235,733	4,530	2.0%	4,530	2.0%
Capital Financing*	139,542	139,490	6,198	145,688	(52)	0.0%	6,146	4.4%
Total Levy Requirement	954,419	969,916	27,448	997,363	15,497	1.6%	42,945	4.5%
Assessment Growth						(1.0%)		(1.0%)
Reassessment						0.0%		0.0%
Levy Restrictions						0.1%		0.1%
Tax Policy						0.0%		0.0%
Education Impact						(0.3%)		(0.3%)
Total Average Residential Tax Impact						0.4%		3.3%

* Capital Financing includes the Area Rating Special Capital Reinvestment provision allocated to the pre-amalgamated City of Hamilton through the Tax Operating Budget

City Departments

The 2022 Preliminary Tax Supported Operating Budget for City Departments is proposed at a \$32.3M increase, or 5.5%. This contributes to the average residential tax increase by 2.9% or \$109 for the average home assessed at \$381,000. The preliminary budget includes all costs required to continue the delivery of services provided by the City of Hamilton, as well as strategic investments to advance the Term of Council priorities. Throughout the Budget Process, City staff, in consultation with Council, investigate all grants and other revenues available to municipalities, as well as generate efficiencies in service delivery and operations in an effort to reduce the impact on taxes. Table 4 provides a breakdown of the \$32.3M increase for City Departments, as well as the overall net levy increase of \$42.9M.

Table 4

(\$000's)	2021	2022	Change	
	Restated	Preliminary	Preliminary vs. Restated	
Planning and Economic Development	30,390	30,980	590	1.9%
Healthy and Safe Communities	255,190	268,870	13,681	5.4%
Public Works	266,574	279,668	13,094	4.9%
Legislative	5,171	5,285	113	2.2%
City Manager	13,022	13,616	594	4.6%
Corporate Services	37,673	38,381	708	1.9%
Corporate Financials / Non Program Revenues	(28,383)	(25,046)	3,337	-11.8%
Hamilton Entertainment Facilities	4,037	4,188	151	3.7%
Total City Expenditures	583,674	615,942	32,268	5.5%
Hamilton Police Services	176,587	180,153	3,566	2.0%
Other Boards and Agencies	48,528	49,492	964	2.0%
City Enrichment Fund	6,088	6,088	-	0.0%
Total Boards and Agencies	231,203	235,733	4,530	2.0%
Capital Financing	139,542	145,688	6,146	4.4%
Total Levy Requirement	954,419	997,363	42,945	4.5%
Assessment Growth				(1.0%)
Reassessment				0.0%
Levy Restrictions				0.1%
Tax Policy				0.0%
Education Impact				(0.3%)
Total Average Residential Tax Impact				3.3%

Table 5 summarizes the individual maintenance items that are having a significant impact in the City departments. Additional information on City department budgets can be found in Appendix 5 “Departmental Budget Summaries”.

Table 5

Budget Drivers - Maintenance	
(\$000's)	2022 Budget Impact
Salaries, Wages and Benefits (net of Funding Agreements)	14,887
Contributions to Reserves	2,194
Curbside Waste Collection	1,969
Social Housing Provider Benchmarks	1,780
Fuel and Energy	750
Recycling Processing & Transfer Station / Community Recycling	540
Tim Hortons Field Contractual Agreement	487
PRESTO Operating Agreement	381
Confederation Park Contractual Agreement	165
User Fees	(7,206)
Miscellaneous	(450)
Total Maintenance	15,497

- **\$14.9M** for employee related expenses, primarily salaries, wages and benefits comprise approximately 45% of the City’s gross operating expenses excluding Boards & Agencies. The net increase of \$14.9M is due to contractual settlements, cost of living adjustments (COLA) of 1.60%, increases in premiums for employer provided benefits, Canada Pension Plan, Employment Insurance and Workers’ Safety and Insurance Board and the annualization of staffing changes approved in the 2021 Tax Supported Operating Budget such as the ambulance enhancement to Paramedic Services;
- **\$2.2M** in additional contributions to reserves for inflationary pressures related to vehicle and fleet replacement. It is important to ensure that contributions to capital reserves increase in line with inflation in order to meet long-term asset replacement obligations;

- **\$2.0M** has been included as a budget pressure for year two of the curbside waste collection contract negotiated in late 2020;
- **\$1.8M** pressure related to Provincial benchmarks for Social Housing providers. The benchmark increases are largely driven by substantial year-over-year increases in hydro, fuel and insurance.
- **\$0.8M** net inflationary pressure for energy and fuel. The 2022 Preliminary Tax Operating Budget includes a \$0.4M contribution from the Tax Stabilization Reserve to offset perceived one-time fluctuations in current market rates for fuel. The net pressure of \$0.8M reflects the estimated ongoing pressure;
- **\$0.6M** in additional expenditures is projected for the recycling facility processing and Transfer Stations / Community Recycling Centres contracts, which reflect 2% inflationary increases, as well as a 4% increases due to volume;
- **\$0.5M** in contractual obligations for Tim Hortons Field;
- **\$0.4M** forecasted pressure in the PRESTO Operating Agreement based on current user estimates;
- **\$0.2M** in contractual pressures for Confederation Beach Park related to insurance and the increase in seasonal wages;
- **(\$7.2M)** in additional revenues from user fees based on the fees contained in the 2022 Tax Supported User Fees Report (FCS21115) ratified by Council on December 15, 2021. User fees were increased at the rate of inflation in accordance with the Council approved guideline; and,
- **(\$0.5M)** in net reductions for all other items as a result of efficiencies realized in the review of all City provided services.

The 2022 Preliminary Tax Supported Operating Budget also includes strategic investments that advance Term of Council priorities that were previously approved through Strategic or Master Plans or other in-year staff reports. The Strategic Priorities impacting the 2022 budget are highlighted in Table 6.

Table 6

Strategic Priorities	
(\$000's)	2022 Budget Impact
Fiscal Health and Financial Management	10,427
Capital Levy Increase	6,198
Insurance	2,829
Area Rating for Fire Services	1,400
Multi-Modal Transportation, EDI and Climate Change	5,370
10-Year Local Transit Strategy	4,144
Sidewalk Snow Clearing	936
Equity, Diversity and Inclusion Roadmap and Implementation	290
Affordable Housing and Homelessness	4,362
Rent Ready Program	1,483
National Housing Strategy	1,264
Subsidy for Social Housing Providers - Federal "Gazette" funding	1,215
Roxborough Housing Incentive Program	400
COVID-19 Resilience	1,281
Macassa Lodge Redevelopment	900
Area Rating for Parkland Purchases	381
Operating Impacts from Capital	3,372
Information Technology	1,121
Forestry, Parks and Open Space	666
Hamilton Fire Department	463
Recreation	250
West Harbour & Waterfront Strategic Initiative	190
Multi-Modal Transportation	180
Hamilton Paramedic Service	177
Roads	74
Others	251
Provincial Funding	2,635
Public Health Services - Provincial Funding Agreement	2,025
Children's Services - Provincial Funding Agreement	206
Long-Term Care - High Wage Transition Funding	202
Waste Management - Household Hazardous Waste Program	202
Total Strategic Priorities	27,448

(*) Anomalies due to rounding

- **Fiscal Health and Financial Management (\$10.4M):** as approved through the 2022 Tax Supported Capital Budget (Report FCS21096), the operating budget includes a \$4.8M increase in the Capital Levy for discretionary block funding for the dedicated purpose of asset rehabilitation, as well as an additional \$1.4M for annual debt repayments related to ICIP – Transit and West Harbour investments. The 2022 budget also reflects the phase-in for the impact of rural fire area rating (\$1.4M). The phase-in was approved through the 2021 budget process on May 12, 2021 in order to soften the immediate impact in the 2021 budget;
- **Multi-Modal Transportation, Equity Diversity and Inclusion, and Climate Change (\$5.4M):** the proposed 2022 budget includes the financial impact of year 6 of the implementation of the 10-Year Local Transit Strategy (\$4.1M), as well as the sidewalk snow clearing enhancement along bus routes that was approved by Council on April 28, 2021. The total cost of the enhancement is estimated at \$4.4M annually with an impact of \$0.9M in 2022 and \$3.5M in 2023. As approved through Report HUR19019(b), the 2022 budget includes \$0.3M for the Equity, Diversity and Inclusion Roadmap and Implementation Plan;
- **Affordable Housing and Homelessness (\$4.4M):** Strategic investments for 2022 include additional contributions to the Rent Ready Program (\$1.5M), loan repayments for the Canadian Mortgage Housing Corporation National Housing Strategy Co-Investment Fund (\$1.3M), continuation of the Roxborough Housing Incentive Program (\$0.4M) and ensuring continuity of service by replacing decreased revenues from Federal subsidy (\$1.2M). Further to the investments impacting the net levy in 2022, the City of Hamilton is committed to continue building on COVID-19 emergency supports to a more responsive, resilient, sustainable and housing-focused homeless serving system, as detailed in Report HSC20020(d). The expenses for the operation of isolation services, drop-ins and hotel rooms for expanded temporary sheltering have been included in the 2022 Preliminary Budget with dedicated funding up to March 31, 2022.
- **COVID-19 Resilience (\$1.3M):** through Report HSC20050(b), Council approved the financing plan for the redevelopment of Macassa Lodge. The total project cost of \$27.8M was funded through a \$19.3M loan from the Unallocated Capital Levy Reserve, \$7.3M from development charges and \$1.3M from grants from the Ministry of Long-Term Care. A \$0.9M pressure has been included in the 2022 budget, representing the first annual loan repayment to the Unallocated Capital Levy Reserve. The Macassa Lodge redevelopment is a 20 bed addition, as well as the enhancement of 44 beds from 2-person rooms to single occupancy. The 2022 budget also includes \$0.4M for loan repayments related to additional park space that was purchased in response to rising demand for outdoor recreation space;
- **Operating Impacts from Capital (\$3.4M):** the budget includes \$3.4M of operating impacts for approved capital projects through the 2021 Capital Budget (Report FCS20101), as well as, operating impacts that were previously approved but deferred to 2022. The \$3.4M budget pressure includes the addition of 13.3 full-time equivalent staff positions;

- Provincial Funding Agreements (\$2.6M):** changes in Provincial Funding Agreements continues to represent a significant budget pressure for 2022. The funding for mandatory programs and the mitigation funding received is based on 2018 expenses. Even with the one-time mitigation funding for Public Health in 2022, the Ministry of Health funding will only be approximately 70% of total costs as a result of cost increases since 2018. In 2022, the transition funding for Children’s Services comes to an end, as well as the long-standing High Wage Transition Funding for Long-Term Care and the Household Hazardous Waste Program. In order to ensure service continuity, the City of Hamilton has absorbed the \$2.6M of lost annual funding for these programs.

Boards & Agencies

The 2022 Boards and Agencies budget is projected to increase by \$4.5M or 2.0% (excluding capital financing), which represents a tax impact for the average residential property of 0.3% or \$13 for the average home assessed at \$381,000. Table 6 summarizes the Boards and Agencies budgets.

Table 7

2022 Boards & Agencies Preliminary Budgets (\$000's)					
Board/Agency	2021	2022 NET		Change	
	Budget Net \$	Preliminary Budget \$	\$	%	
Conservation Authorities	\$ 8,460	\$ 8,627	\$ 167	2.0%	
MPAC	\$ 6,980	\$ 6,980	\$ -	0.0%	
Hamilton Beach Rescue Unit	\$ 132	\$ 134	\$ 3	2.0%	
Hamilton Farmers' Market	\$ 115	\$ 242	\$ 127	110.6%	
Royal Botanical Gardens	\$ 647	\$ 660	\$ 13	2.0%	
Hamilton Police Services	\$ 175,352	\$ 178,884	\$ 3,532	2.0%	
Hamilton Public Library	\$ 32,028	\$ 32,682	\$ 654	2.0%	
City Enrichment Fund	\$ 6,088	\$ 6,088	\$ -	0.0%	
Total for Above Items					
<i>excluding Capital Financing</i>	\$ 229,802	\$ 234,298	\$ 4,496	2.0%	

The budget pressure for the Hamilton Police Service of \$3.5M is based on Council’s directed target levy increase of 2.0%. The Hamilton Police Service budget submission will be presented to the Police Services Board in December 2021. Any increase beyond the 2.0% guideline will be presented to the General Issues Committee for consideration with an appropriate explanation in January 2022. The Hamilton Public Library has submitted a budget within the 2.0% guideline at a \$0.7M (2.0%) increase from 2021 for consideration of the General Issues Committee.

Similar to the Hamilton Police Service, Conservation Authorities, Hamilton Beach Rescue Unit and the Royal Botanical Gardens operating budgets have been included at Council's guideline of a 2.0% increase. Any increase beyond the 2.0% guideline will be presented to the General Issues Committee for consideration with an appropriate explanation in January 2022. The Municipal Property Assessment Corporation (MPAC) budget has been confirmed at a zero increase for 2022. The Hamilton Farmers' Market and City Enrichment Fund budgets have been included at their requested increases for General Issues Committee consideration.

All stakeholders within Boards and Agencies, with the exception of the City Enrichment Fund and the MPAC, will present their budgets at General Issues Committee on January 18th and 20th, 2022. Additional budget information can be found in Appendix 5 "Departmental Budget Summaries - Other Programs".

Capital Financing

The operating budget portion of the 2022 Tax Supported Capital Budget is increasing by \$6.2M representing a net tax impact of 0.4% (or \$14) for the average residential property assessed at \$381,000 after considering assessment growth. Table 8 outlines the components contributing to the additional investment.

Table 8

Capital Financing		
	2022	
	Change (\$000's)	Net Levy %
Capital Tax Levy - Discretionary Blocks	4,800	0.5%
Investing in Canada Infrastructure Program - Transit	1,024	0.1%
West Harbour Strategic Initiatives	374	0.0%
Internal Loan Repayments	(18)	0.0%
Total	6,180	0.6%

A \$4.8M increase (0.50% net levy increase) to the Capital Levy has been included in 2022 to fund discretionary block funded projects as approved by Council on December 15, 2021 through Report FCS21096. In addition, debt financing requirements have resulted in a further net levy increase of \$1.2M, or 0.15%, for the debt related financing of the municipal share for the Investing in Canada Infrastructure Program ICIP – Public Transit Stream and West Harbour strategic initiatives.

The 2022 Tax Supported Capital Budget was presented to Council for consideration on November 26, 2021. The City of Hamilton's 2022 Tax Supported Capital Budget and 10-year Tax Supported Capital Program supports the City's Strategic Plan and Long-Term Capital Financing Plan. The approved 2022 Tax-Supported Capital Projects align with the following City objectives:

- Maintaining existing assets in a state-of-good-repair and a commitment to asset stewardship best practices;
- Resiliency and economic recovery in response to the COVID-19 global pandemic;
- Leveraging funding programs from senior levels of government for transit, culture and recreation, affordable housing, disaster mitigation and adaptation, long-term care and climate change initiatives;
- Continuation of year six of the 10-Year Local Transit Strategy, as well as, other commitments to support multi-modal transportation options across the municipality;
- Providing affordable housing and capacity building across the community; and
- Supporting integrated growth and development to ensure long-term sustainability and opportunities for residential and business development in the City.

COVID-19 ECONOMIC RECOVERY AND FINANCIAL PRESSURES

The COVID-19 pandemic has resulted in many changes affecting human behavior and impacting the world's economic condition. Municipalities were hit particularly hard as they managed service continuity for essential services and infrastructure during the lockdown period. While financial pressures for municipalities in 2020 and 2021 are expected to be fully mitigated through the historic Safe Restart Agreement, Social Services Relief Fund and many other funding announcements, it is anticipated that health risks will continue to remain on an ongoing basis and economic activity is not expected to return to pre-COVID-19 levels beyond 2021.

As the economy reopens, municipalities will play a crucial role in implementing public health safeguards and community support for the most vulnerable. It is essential that municipalities continue to provide service continuity for front-line workers and to play a key role in local economic recovery through rebuilding growth and providing stimulus.

The City will continue to face many financial pressures in 2022 including the loss of revenue from transit operations and recreation user fees, as well as, increased costs for Public Health response and vaccination programs and emergency shelters for housing the most vulnerable. In accordance with existing funding agreements, the City will have approximately \$38.2M in remaining eligible funds that can be carried over into 2022 to address its COVID-19 related financial pressures, as well as reasonable assurance that the Ministry of Health will continue fund the response and vaccination programs dollar for dollar. However, there have been no announcements related to continued funding to address pressures in 2022 and the City's forecast currently exceeds total funding available.

Based on current information, staff project financial pressures of \$92.9M in 2022 related to the COVID-19 pandemic. It is forecasted that the City of Hamilton will have \$38.2M remaining in eligible funds from the Safe Restart Agreement – Transit, Social Services Relief Fund and Recovery Funding for Municipalities Program to address ongoing pressures. The 2022 Preliminary Tax Operating Budget assumes that all pressures related to COVID-19 will be funded from senior levels of government and staff will continue to pursue advocacy efforts for relief funding and potential economic stimulus funding programs to address the shortfall.

Table 9 provides a breakdown of the financial pressures related to the COVID-19 pandemic projected in 2022.

COVID-19 Financial Pressures (\$000's)	
Department	2022 Fore cast
Planning and Economic Development	4,700
Healthy and Safe Communities	79,929
Public Works	5,681
Corporate Financials and Non-Program Revenues	2,600
Subtotal	92,910
Safe Restart Agreement - Transit	(4,495)
Recovery Funding for Municipalities Program	(16,780)
Social Services Relief Fund	(16,900)
Ministry of Health	(46,158)
Uncommitted (City of Hamilton Reserves)	(8,577)
Net Levy Impact	-

STAFF COMPLEMENT

The 2022 Preliminary Tax Supported Operating Budget is submitted with a staff complement net increase of 73.8 full-time equivalent staff positions (FTE), excluding Boards and Agencies, compared to the 2021 Restated Complement. Table 10 illustrates the changes from 2021.

Table 10

2022 Preliminary Complement (FTE) (exclusive of Boards & Agencies)		
		Change
2021 Approved	5,886.6	
2021 Restated	5,892.0	5.4
Impacts from Capital		13.3
Other Complement Change		60.5
2022 Preliminary	5,965.8	73.8

* - Anomalies due to rounding

The difference of 5.4 FTE between the 2021 Approved and 2021 Restated is the result of additional positions added in-year through Reports PED21151 and BOH21010, as well as the annualization of previously approved operating impacts of capital.

The total increase of 73.8 FTE in the 2022 submission is inclusive of 13.3 FTE for operating impacts of previously approved capital works, 43.0 FTE for the implementation of year 6 of the Ten-Year Local Transit Strategy, 5.0 FTE for property and liability insurance approved through Report LS21027, 4.0 FTE for the Rental Housing Pilot Project approved through Report PED21097/LS21022, and 2.0 FTE for the Equity, Diversity and Inclusion Framework approved through Report HUR19019(b).

A detailed complement summary is provided in Appendix 4 “Complement Summary”, which includes footnotes explaining the changes in staff complement. Departmental presentations to GIC will provide additional information with respect to complement changes.

COUNCIL REFERRED ITEMS & BUSINESS CASES

Not included in the 2022 Preliminary Tax Supported Operating Budget are any items that were considered at Council via staff report or Councillor’s Motion and referred to the budget process for further discussion. Business Cases submitted by departments for Council’s consideration have also been excluded from the preliminary budget.

There are currently six Council Referred Items included in Appendix 6 “Council Referred Items” for Council’s consideration with a net impact of \$0.2M or 0.02% tax impact. Any items that are referred to the budget process in the coming weeks will be compiled and added to an appendix to the 2022 Tax Supported Operating Budget – Recommendations Report and discussed during deliberations at GIC in February, 2022.

All Business Cases submitted for Council’s consideration in the 2022 Budget Process have been included in Appendix 7 “Business Cases”. There are a total of eleven submissions representing a net levy increase of \$1.2M and 27.80 FTE. If approved, the impact on the average residential tax bill would be an additional 0.16%.

MULTI-YEAR BUDGET OUTLOOK

The initial outlook for 2023 and 2024 prepared during the 2021 budget process resulted in projected tax increases of 2.5% and 3.0% respectively. However, these projections have been re-evaluated based on current information including known factors such as contractual agreements and operating impacts from capital projects, as well as service adjustments approved by Council.

The multi-year outlook for 2023-2025 is provided in Appendix 8 “Multi-Year Outlook”. Table 11 shows the projected levy and tax increases for the 2023-2025 period.

Table 11

2023 - 2025 Multi-Year Outlook						
(\$000's)	2023		2024		2025	
	\$	%	\$	%	\$	%
Total City Departments	\$ 26,021,800	4.2%	\$ 23,733,800	2.3%	\$ 24,420,030	2.9%
Boards & Agencies	\$ 5,170,349	2.2%	\$ 4,890,083	2.0%	\$ 4,914,228	2.0%
Capital Financing	\$ 5,471,000	3.8%	\$ 6,629,000	4.4%	\$ 4,854,000	3.1%
Total Preliminary Operating Budget	\$ 36,663,149	3.7%	\$ 35,252,883	3.4%	\$ 34,188,258	3.2%
Residential Average Property Tax Impact		3.5%		3.0%		2.8%

Significant increases in future budgets are the result of service enhancements in Transit, both as a result of the continuation of the 10-Year Local Transit Strategy and increases in the DARTS contract with projected increases in ridership.

Additionally, a standard Capital Levy increase of 0.5% has been included in years 2023-2025 for the purposes of funding discretionary block funded projects and addressing Asset Management Planning requirements. Increases to the Capital Levy for debt servicing requirements for the municipal share of the Investing in Canada Infrastructure – Public Transit Stream and West Harbour Waterfront Strategic Initiatives have been included as well. The corporate financials section includes increases resulting from the operating impacts of capital projects.

Actions taken to mitigate the pressures in the 2022 budget should not include postponing expenditures to future years but rather, they should be geared towards finding sustainable solutions.

For every year, the residential tax increase assumes a growth benefit of (1.0%) based on historical results and a reassessment impact of 0.5%. These assumptions, as well as all the other assumptions used in the preparation of the outlook such as the rate of inflation and the utility guidelines will be revised annually.

The multi-year budgets will be included in the departmental presentations, which are scheduled to begin on January 25, 2022.

**2022
Preliminary
Tax Supported
Operating Budget
Net Levy
Summary**

NET LEVY SUMMARY

	2021		2022 Preliminary Budget vs. 2021 Restated
	Restated Budget	Projected Actual	
PLANNING & ECONOMIC DEVELOPMENT			
General Manager	1,058,110	797,688	(2,710) (0.3)%
Transportation, Planning & Parking Building	2,068,200	2,037,841	168,120 8.1%
Economic Development	617,440	1,161,083	(9,820) (1.6)%
Growth Management	5,584,010	5,312,761	84,060 1.5%
Licensing & By-Law Services	490,160	25,553	(463,430) (5.5)%
Planning	6,801,670	6,267,011	141,850 2.1%
Tourism & Culture	4,280,610	3,425,263	21,300 0.5%
TOTAL PLANNING & ECONOMIC DEVELOPMENT	30,389,730	28,333,847	590,330 1.9%
HEALTHY & SAFE COMMUNITIES			
HSC Administration	3,363,130	3,388,620	226,850 6.7%
Children's Services & Neighbourhood Dev.	10,439,330	10,542,420	43,180 0.4%
Ontario Works	12,321,930	10,327,420	520,210 4.2%
Housing Services	47,325,860	43,215,360	6,611,640 14.0%
Long Term Care	11,524,860	9,447,360	243,460 2.1%
Recreation	35,319,640	35,263,950	668,930 1.9%
Hamilton Fire Department	93,288,450	93,073,770	4,237,990 4.5%
Hamilton Paramedic Service	28,102,490	30,317,930	292,900 1.0%
Public Health Services	13,503,920	13,099,630	835,380 6.2%
TOTAL HEALTHY & SAFE COMMUNITIES	255,189,610	248,676,460	13,680,540 5.4%

NET LEVY SUMMARY

	2021		2022 Preliminary Budget vs. 2021 Restated	
	Restated Budget	Projected Actual		
		2022 Preliminary Budget	\$ Change	
			% Change	
PUBLIC WORKS				
PW-General Administration	634,870	634,870	24,030	3.8%
Energy Fleet & Facilities	13,273,690	13,761,440	1,002,400	7.6%
Engineering Services	1,060	(450,000)	(1,060)	(100.0)%
Environmental Services	44,239,840	43,028,770	1,342,470	3.0%
Transit	80,834,700	79,958,980	7,137,310	8.8%
Transportation Operations & Maintenance	83,485,680	77,739,010	748,440	0.9%
Waste Management	44,104,610	42,071,880	2,840,210	6.4%
TOTAL PUBLIC WORKS	266,574,450	256,744,950	13,093,800	4.9%
LEGISLATIVE				
Legislative General	(379,020)	(255,910)	17,040	(4.5)%
Mayors Office	1,192,900	1,152,450	18,520	1.6%
Volunteer Committee	120,650	120,650	0	0.0%
Ward Budgets	4,236,600	4,236,600	77,820	1.8%
TOTAL LEGISLATIVE	5,171,130	5,253,790	113,380	2.2%
CITY MANAGER				
Office of the City Auditor	1,175,130	1,189,360	26,110	2.2%
CMO - Admin	209,270	349,780	24,250	11.6%
Communication & Strategic Initiatives	2,421,370	2,318,340	95,690	4.0%
Digital & Innovation Office	201,620	409,040	4,630	2.3%
Government & Community Relations	851,540	864,580	16,960	2.0%
Human Resources	8,163,030	7,544,990	426,460	5.2%
TOTAL CITY MANAGER	13,021,960	12,676,090	594,100	4.6%

NET LEVY SUMMARY

	2021		2022		2022 Preliminary Budget vs. 2021 Restated	
	Restated Budget	Projected Actual	Preliminary Budget	\$ Change	% Change	
CORPORATE SERVICES						
City Clerk's Office	2,995,070	3,061,105	3,168,430	173,360	5.8%	
Customer Service, POA and Fin'l Integration	5,824,460	5,793,566	5,959,640	135,180	2.3%	
Financial Serv. Taxation & Corp Controller	4,085,540	3,577,383	4,284,990	199,450	4.9%	
Legal Services & Risk Management	4,008,810	3,730,333	3,939,580	(69,230)	(1.7)%	
Corporate Services - Administration	328,010	332,838	331,740	3,730	1.1%	
Financial Planning, Admin & Policy	5,219,620	5,016,164	5,371,300	151,680	2.9%	
Information Technology	15,211,770	14,568,249	15,325,680	113,910	0.7%	
TOTAL CORPORATE SERVICES	37,673,280	36,079,638	38,381,360	708,080	1.9%	
CORPORATE FINANCIALS - EXPENDITURES						
Corporate Initiatives	3,354,610	5,897,210	7,639,770	4,285,160	127.7%	
Corporate Pensions, Benefits & Contingency	15,653,960	19,653,960	15,785,390	131,430	0.8%	
TOTAL CORPORATE FINANCIALS - EXPENDITURES	19,008,570	25,551,170	23,425,160	4,416,590	23.2%	
HAMILTON ENTERTAINMENT FACILITIES						
Operating	4,037,180	5,373,640	4,187,710	150,530	3.7%	
TOTAL HAMILTON ENTERTAINMENT FACILITIES	4,037,180	5,373,640	4,187,710	150,530	3.7%	
TOTAL CITY EXPENDITURES	631,065,910	618,689,585	664,413,260	33,347,350	5.3%	

NET LEVY SUMMARY

	2021		2022		2022 Preliminary Budget vs. 2021 Restated	
	Restated Budget	Projected Actual	Preliminary Budget		\$ Change	% Change
CAPITAL FINANCING						
Debt-Healthy & Safe Communities	3,546,160	3,029,000	2,309,070	(1,237,090)		(34.9)%
Debt-Infrastructure Renewal Levy	13,428,870	13,429,000	13,428,870	0		0.0%
Debt-Corporate Financials	89,959,980	86,657,000	92,884,930	2,924,950		3.3%
Debt-Planning & Economic Development	1,563,290	26,000	1,168,790	(394,500)		(25.2)%
Debt-Public Works	31,043,560	26,372,000	35,896,650	4,853,090		15.6%
TOTAL CAPITAL FINANCING	139,541,860	129,513,000	145,688,310	6,146,450		4.4%
BOARDS & AGENCIES						
Police Services						
Operating	175,352,230	175,760,000	178,883,970	3,531,740		2.0%
Capital Financing	1,234,790	296,000	1,269,000	34,210		2.8%
Total Police Services	176,587,020	176,056,000	180,152,970	3,565,950		2.0%
Other Boards & Agencies						
Library	32,027,990	29,060,000	32,682,020	654,030		2.0%
Conservation Authorities	8,459,770	8,459,770	8,627,130	167,360		2.0%
MPAC	6,979,670	6,979,670	6,979,670	0		0.0%
Hamilton Beach Rescue Unit	131,570	131,570	134,200	2,630		2.0%
Royal Botanical Gardens	647,410	647,410	660,360	12,950		2.0%
Farmers Market	115,060	172,310	242,360	127,300		110.6%
Total Other Boards & Agencies	48,361,470	45,450,730	49,325,740	964,270		2.0%

NET LEVY SUMMARY

	2021		2022 Preliminary Budget vs. 2021 Restated	2022 Preliminary Budget	2022 Preliminary Budget vs. 2021 Restated	% Change
	Restated Budget	Projected Actual				
Capital Financing - Other Boards & Agencies	166,280	0	(280)	166,000	(280)	(0.2)%
City Enrichment Fund	6,088,340	6,088,340	0	6,088,340	0	0.0%
TOTAL BOARDS & AGENCIES	231,203,110	227,595,070	4,529,940	235,733,050	4,529,940	2.0%
TOTAL EXPENDITURES	1,001,810,880	975,797,655	44,023,740	1,045,834,620	44,023,740	4.4%
NON PROGRAM REVENUES						
Payment In Lieu	(16,399,700)	(16,399,700)	(708,740)	(17,108,440)	(708,740)	4.3%
Penalties and Interest	(11,000,000)	(11,000,000)	(400,000)	(11,400,000)	(400,000)	3.6%
Right of Way	(3,227,000)	(3,227,000)	(1,880)	(3,228,880)	(1,880)	0.1%
Senior Tax Credit	537,000	537,000	(7,170)	529,830	(7,170)	(1.3)%
Supplementary Taxes	(9,925,000)	(9,925,000)	(205,000)	(10,130,000)	(205,000)	2.1%
Tax Remissions and Write Offs	9,570,000	9,570,000	180,000	9,750,000	180,000	1.9%
Hydro Dividend and Other Interest	(5,281,480)	(5,281,480)	0	(5,281,480)	0	0.0%
Investment Income	(4,100,000)	(4,100,000)	0	(4,100,000)	0	0.0%
Slot Revenues	(5,200,000)	(5,200,000)	0	(5,200,000)	0	0.0%
POA Revenues	(2,365,770)	(4,736,430)	63,550	(2,302,220)	63,550	(2.7)%
TOTAL NON PROGRAM REVENUES	(47,391,950)	(49,762,610)	(1,079,240)	(48,471,190)	(1,079,240)	2.3%
TOTAL LEVY REQUIREMENT	954,418,930	926,035,045	42,944,500	997,363,430	42,944,500	4.5%

**2022
Preliminary
Tax Supported
Operating Budget
Gross and Net
Expenditures
Summary**

GROSS AND NET EXPENDITURES SUMMARY

	Gross Expenses			Gross Revenues			Net Operating Budget			
	2021 Restated Budget	2022 Preliminary Budget	% Change	2021 Restated Budget	2022 Preliminary Budget	% Change	2021 Restated Budget	2022 Preliminary Budget	2022 Preliminary Budget vs. 2021 Restated Change \$	Change %
PLANNING & ECONOMIC DEVELOPMENT										
General Manager	1,044,630	1,055,400	1.0%	13,480	0	100.0%	1,058,110	1,055,400	(2,710)	(0.3)%
Transportation, Planning & Parking	16,889,770	17,082,940	1.1%	(14,821,570)	(14,846,220)	(0.2)%	2,068,200	2,236,320	168,120	8.1%
Building	15,228,660	15,634,620	2.7%	(14,611,220)	(15,027,000)	(2.8)%	617,440	607,620	(9,820)	(1.6)%
Economic Development	7,576,380	7,692,260	1.5%	(1,992,370)	(2,024,190)	(1.6)%	5,584,010	5,668,070	84,060	1.5%
Growth Management	6,706,040	7,256,930	8.2%	(6,215,880)	(6,793,500)	(9.3)%	490,160	463,430	(26,730)	(5.5)%
Licensing & By-Law Services	13,177,530	13,402,310	1.7%	(6,375,860)	(6,458,790)	(1.3)%	6,801,670	6,943,520	141,850	2.1%
Planning	8,945,810	9,568,480	7.0%	(4,665,200)	(5,266,570)	(12.9)%	4,280,610	4,301,910	21,300	0.5%
Tourism & Culture	10,527,190	10,719,240	1.8%	(1,037,660)	(1,015,450)	2.1%	9,489,530	9,703,790	214,260	2.3%
TOTAL PLANNING & ECONOMIC DEVELOPMENT	80,096,010	82,411,780	2.9%	(49,706,280)	(51,431,720)	(3.5)%	30,389,730	30,980,060	590,330	1.9%
HEALTHY & SAFE COMMUNITIES										
HSC Administration	3,836,940	4,044,840	5.4%	(473,810)	(454,860)	4.0%	3,363,130	3,589,980	226,850	6.7%
Children's Services & Neighbourhood Dev.	93,083,390	95,869,880	3.0%	(82,644,060)	(85,387,370)	(3.3)%	10,439,330	10,482,510	43,180	0.4%
Ontario Works	145,377,470	145,674,520	0.2%	(133,055,540)	(132,832,380)	0.2%	12,321,930	12,842,140	520,210	4.2%
Housing Services	97,654,960	120,331,290	23.2%	(50,329,100)	(66,393,790)	(31.9)%	47,325,860	53,937,500	6,611,640	14.0%
Long Term Care	44,818,490	47,010,500	4.9%	(33,293,630)	(35,242,180)	(5.9)%	11,524,860	11,768,320	243,460	2.1%
Recreation	54,777,680	55,975,450	2.2%	(19,458,040)	(19,986,880)	(2.7)%	35,319,640	35,988,570	668,930	1.9%
Hamilton Fire Department	95,338,160	99,031,680	3.9%	(2,049,710)	(1,505,240)	26.6%	93,288,450	97,526,440	4,237,990	4.5%
Hamilton Paramedic Service	61,497,880	64,184,740	4.4%	(33,395,390)	(35,789,350)	(7.2)%	28,102,490	28,395,390	292,900	1.0%
Public Health Services	68,774,000	101,606,170	47.7%	(55,270,080)	(87,266,870)	(57.9)%	13,503,920	14,339,300	835,380	6.2%
TOTAL HEALTHY & SAFE COMMUNITIES	665,168,970	733,729,070	10.3%	(409,969,360)	(464,868,920)	(13.4)%	255,189,610	268,870,150	13,680,540	5.4%

GROSS AND NET EXPENDITURES SUMMARY

	Gross Expenses			Gross Revenues			Net Operating Budget			
	2021 Restated Budget	2022 Preliminary Budget	% Change	2021 Restated Budget	2022 Preliminary Budget	% Change	2021 Restated Budget	2022 Preliminary Budget	2022 Preliminary Budget vs. 2021 Restated Change \$	Change %
PUBLIC WORKS										
PW-General Administration	634,870	658,900	3.8%	0	0	0.0%	634,870	658,900	24,030	3.8%
Energy Fleet & Facilities	20,591,760	21,946,740	6.6%	(7,318,070)	(7,670,650)	(4.8)%	13,273,690	14,276,090	1,002,400	7.6%
Engineering Services	4,385,940	4,641,230	5.8%	(4,384,880)	(4,641,230)	(5.8)%	1,060	0	(1,060)	(100.0)%
Environmental Services	47,124,380	48,556,680	3.0%	(2,884,540)	(2,974,370)	(3.1)%	44,239,840	45,582,310	1,342,470	3.0%
Transit	141,598,570	150,197,660	6.1%	(60,763,870)	(62,225,650)	(2.4)%	80,834,700	87,972,010	7,137,310	8.8%
Transportation Operations & Maintenance	90,581,310	91,441,190	0.9%	(7,095,630)	(7,207,070)	(1.6)%	83,485,680	84,234,120	748,440	0.9%
Waste Management	58,942,610	62,013,470	5.2%	(14,838,000)	(15,068,650)	(1.6)%	44,104,610	46,944,820	2,840,210	6.4%
TOTAL PUBLIC WORKS	363,859,440	379,455,870	4.3%	(97,284,990)	(99,787,620)	(2.6)%	266,574,450	279,668,250	13,093,800	4.9%
LEGISLATIVE										
Legislative General	(379,020)	(361,980)	(4.5)%	0	0	0.0%	(379,020)	(361,980)	17,040	(4.5)%
Mayors Office	1,192,900	1,211,420	1.6%	0	0	0.0%	1,192,900	1,211,420	18,520	1.6%
Volunteer Committee	124,650	124,650	0.0%	(4,000)	(4,000)	0.0%	120,650	120,650	0	0.0%
Ward Budgets	4,236,600	4,314,420	1.8%	0	0	0.0%	4,236,600	4,314,420	77,820	1.8%
TOTAL LEGISLATIVE	5,175,130	5,288,510	2.2%	(4,000)	(4,000)	0.0%	5,171,130	5,284,510	113,380	2.2%
CITY MANAGER										
Office of the City Auditor	1,205,130	1,231,240	2.2%	(30,000)	(30,000)	0.0%	1,175,130	1,201,240	26,110	2.2%
CMO - Admin	209,270	233,520	11.6%	0	0	0.0%	209,270	233,520	24,250	11.6%
Communication & Strategic Initiatives	2,451,370	2,547,060	3.9%	(30,000)	(30,000)	0.0%	2,421,370	2,517,060	95,690	4.0%
Digital & Innovation Office	850,110	858,810	1.0%	(648,490)	(652,560)	(0.6)%	201,620	206,250	4,630	2.3%
Government & Community Relations	851,540	868,500	2.0%	0	0	0.0%	851,540	868,500	16,960	2.0%
Human Resources	10,196,740	10,541,910	3.4%	(2,033,710)	(1,952,420)	4.0%	8,163,030	8,589,490	426,460	5.2%
TOTAL CITY MANAGER	15,764,160	16,281,040	3.3%	(2,742,200)	(2,664,980)	2.8%	13,021,960	13,616,060	594,100	4.6%

GROSS AND NET EXPENDITURES SUMMARY

	Gross Expenses			Gross Revenues			Net Operating Budget			
	2021 Restated Budget	2022 Preliminary Budget	% Change	2021 Restated Budget	2022 Preliminary Budget	% Change	2021 Restated Budget	2022 Preliminary Budget	2022 Preliminary Budget vs. 2021 Restated Change \$	Change %
CORPORATE SERVICES										
City Clerk's Office	3,580,670	3,800,800	6.1%	(585,600)	(632,370)	(8.0)%	2,995,070	3,168,430	173,360	5.8%
Customer Service, POA and Fin ¹ Integration	12,395,640	12,606,240	1.7%	(6,571,180)	(6,646,600)	(1.1)%	5,824,460	5,959,640	135,180	2.3%
Financial Serv, Taxation & Corp Controller	6,890,270	7,129,190	3.5%	(2,804,730)	(2,844,200)	(1.4)%	4,085,540	4,284,990	199,450	4.9%
Legal Services & Risk Management	4,164,670	4,097,440	(1.6)%	(155,860)	(157,860)	(1.3)%	4,008,810	3,939,580	(69,230)	(1.7)%
Corporate Services - Administration	328,010	345,520	5.3%	0	(13,780)	0.0%	328,010	331,740	3,730	1.1%
Financial Planning, Admin & Policy	6,729,220	6,885,630	2.3%	(1,509,600)	(1,514,330)	(0.3)%	5,219,620	5,371,300	151,680	2.9%
Information Technology	15,980,480	16,095,210	0.7%	(768,710)	(769,530)	(0.1)%	15,211,770	15,325,680	113,910	0.7%
TOTAL CORPORATE SERVICES	50,068,960	50,960,030	1.8%	(12,395,680)	(12,578,670)	(1.5)%	37,673,280	38,381,360	708,080	1.9%
CORPORATE FINANCIALS - EXPENDITURES										
Corporate Initiatives	3,997,920	7,826,370	95.8%	(643,310)	(186,600)	71.0%	3,354,610	7,639,770	4,285,160	127.7%
Corporate Pensions, Benefits & Contingency	15,653,960	15,785,390	0.8%	0	0	0.0%	15,653,960	15,785,390	131,430	0.8%
TOTAL CORPORATE FINANCIALS - EXPENDITURES	19,651,880	23,611,760	20.2%	(643,310)	(186,600)	71.0%	19,008,570	23,425,160	4,416,590	23.2%
HAMILTON ENTERTAINMENT FACILITIES										
Operating	4,402,950	4,578,480	4.0%	(365,770)	(390,770)	(6.8)%	4,037,180	4,187,710	150,530	3.7%
TOTAL HAMILTON ENTERTAINMENT FACILITIES	4,402,950	4,578,480	4.0%	(365,770)	(390,770)	(6.8)%	4,037,180	4,187,710	150,530	3.7%
TOTAL CITY EXPENDITURES	1,204,177,500	1,296,316,540	7.6%	(573,111,590)	(631,903,280)	(10.3)%	631,065,910	664,413,260	33,347,350	5.3%

GROSS AND NET EXPENDITURES SUMMARY

	Gross Expenses			Gross Revenues			Net Operating Budget			
	2021 Restated Budget	2022 Preliminary Budget	% Change	2021 Restated Budget	2022 Preliminary Budget	% Change	2021 Restated Budget	2022 Preliminary Budget	2022 Preliminary Budget vs. 2021 Restated Change \$	Change %
CAPITAL FINANCING										
Debt-Healthy & Safe Communities	5,712,040	5,491,550	(3.9)%	(2,165,880)	(3,182,480)	(46.9)%	3,546,160	2,309,070	(1,237,090)	(34.9)%
Debt-Infrastructure Renewal Levy	13,428,870	13,428,870	0.0%	0	0	0.0%	13,428,870	13,428,870	0	0.0%
Debt-Corporate Financials	89,959,980	92,884,930	3.3%	0	0	0.0%	89,959,980	92,884,930	2,924,950	3.3%
Debt-Planning & Economic Development	1,624,470	1,229,970	(24.3)%	(61,180)	(61,180)	0.0%	1,563,290	1,168,790	(394,500)	(25.2)%
Debt-Public Works	38,876,010	43,640,650	12.3%	(7,832,450)	(7,744,000)	1.1%	31,043,560	35,896,650	4,853,090	15.6%
TOTAL CAPITAL FINANCING	149,601,370	156,675,970	4.7%	(10,059,510)	(10,987,660)	(9.2)%	139,541,860	145,688,310	6,146,450	4.4%
BOARDS & AGENCIES										
Police Services										
Operating	187,503,130	191,034,870	1.9%	(12,150,900)	(12,150,900)	0.0%	175,352,230	178,883,970	3,531,740	2.0%
Capital Financing	1,534,790	1,713,000	11.6%	(300,000)	(444,000)	(48.0)%	1,234,790	1,269,000	34,210	2.8%
Total Police Services	189,037,920	192,747,870	2.0%	(12,450,900)	(12,594,900)	(1.2)%	176,587,020	180,152,970	3,565,950	2.0%
Other Boards & Agencies										
Library	33,676,680	34,502,410	2.5%	(1,648,690)	(1,820,390)	(10.4)%	32,027,990	32,682,020	654,030	2.0%
Conservation Authorities	8,459,770	8,627,130	2.0%	0	0	0.0%	8,459,770	8,627,130	167,360	2.0%
MPAC	6,979,670	6,979,670	0.0%	0	0	0.0%	6,979,670	6,979,670	0	0.0%
Hamilton Beach Rescue Unit	131,570	134,200	2.0%	0	0	0.0%	131,570	134,200	2,630	2.0%
Royal Botanical Gardens	647,410	660,360	2.0%	0	0	0.0%	647,410	660,360	12,950	2.0%
Farmers Market	811,160	804,860	(0.8)%	(696,100)	(562,500)	19.2%	115,060	242,360	127,300	110.6%

GROSS AND NET EXPENDITURES SUMMARY

	Gross Expenses			Gross Revenues			Net Operating Budget			
	2021 Restated Budget	2022 Preliminary Budget	% Change	2021 Restated Budget	2022 Preliminary Budget	% Change	2021 Restated Budget	2022 Preliminary Budget	2022 Preliminary Budget vs. 2021 Restated Change \$	Change %
Capital Financing - Other Boards & Agencies	447,770	447,500	(0.1)%	(281,490)	(281,500)	(0.0)%	166,280	166,000	(280)	(0.2)%
City Enrichment Fund	6,088,340	6,088,340	0.0%	0	0	0.0%	6,088,340	6,088,340	0	0.0%
TOTAL BOARDS & AGENCIES	246,280,290	250,992,340	1.9%	(15,077,180)	(15,259,290)	(1.2)%	231,203,110	235,733,050	4,529,940	2.0%

	Gross Expenses			Gross Revenues			Net Operating Budget			
	2021 Restated Budget	2022 Preliminary Budget	% Change	2021 Restated Budget	2022 Preliminary Budget	% Change	2021 Restated Budget	2022 Preliminary Budget	2022 Preliminary Budget vs. 2021 Restated Change \$	Change %
TOTAL EXPENDITURES	1,600,059,160	1,703,984,850	6.5%	(598,248,280)	(658,150,230)	(10.0)%	1,001,810,880	1,045,834,620	44,023,740	4.4%
NON PROGRAM REVENUES										
Payment In Lieu	500,000	400,000	(20.0)%	(16,899,700)	(17,508,440)	(3.6)%	(16,399,700)	(17,108,440)	(708,740)	4.3%
Penalties and Interest	0	0	0.0%	(11,000,000)	(11,400,000)	(3.6)%	(11,000,000)	(11,400,000)	(400,000)	3.6%
Right of Way	0	0	0.0%	(3,227,000)	(3,228,880)	(0.1)%	(3,227,000)	(3,228,880)	(1,880)	0.1%
Senior Tax Credit	635,000	609,000	(4.1)%	(98,000)	(79,170)	19.2%	537,000	529,830	(7,170)	(1.3)%
Supplementary Taxes	100,000	70,000	(30.0)%	(10,025,000)	(10,200,000)	(1.7)%	(9,925,000)	(10,130,000)	(205,000)	2.1%
Tax Remissions and Write Offs	9,570,000	9,750,000	1.9%	0	0	0.0%	9,570,000	9,750,000	180,000	1.9%
Hydro Dividend and Other Interest	9,562,120	9,562,120	0.0%	(14,843,600)	(14,843,600)	0.0%	(5,281,480)	(5,281,480)	0	0.0%
Investment Income	0	0	0.0%	(4,100,000)	(4,100,000)	0.0%	(4,100,000)	(4,100,000)	0	0.0%
Slot Revenues	0	0	0.0%	(5,200,000)	(5,200,000)	0.0%	(5,200,000)	(5,200,000)	0	0.0%
POA Revenues	0	0	0.0%	(2,365,770)	(2,302,220)	2.7%	(2,365,770)	(2,302,220)	63,550	(2.7)%
TOTAL NON PROGRAM REVENUES	20,367,120	20,391,120	0.1%	(67,759,070)	(68,862,310)	(1.6)%	(47,391,950)	(48,471,190)	(1,079,240)	2.3%

TOTAL LEVY REQUIREMENT	1,620,426,280	1,724,375,970	6.4%	(666,007,350)	(727,012,540)	(9.2)%	954,418,930	997,363,430	42,944,500	4.5%
-------------------------------	----------------------	----------------------	-------------	----------------------	----------------------	---------------	--------------------	--------------------	-------------------	-------------

**2022
Preliminary
Tax Supported
Operating Budget
Cost Category
Summary**

COST CATEGORY SUMMARY

	2021		2021	2022	2022 Preliminary Budget vs. 2021 Restated	
	Restated Budget	Projected Actual	Projected Actual	Preliminary Budget	Change \$	Change %
EMPLOYEE RELATED COST	644,693,840	652,224,264	652,224,264	686,771,300	42,077,460	6.5%
MATERIAL & SUPPLY	53,897,840	55,882,456	55,882,456	57,354,020	3,456,180	6.4%
VEHICLE EXPENSES	36,028,620	36,599,444	36,599,444	38,761,700	2,733,080	7.6%
BUILDING & GROUND	40,243,220	41,355,097	41,355,097	43,081,270	2,838,050	7.1%
CONSULTING	927,530	1,099,878	1,099,878	1,484,130	556,600	60.0%
CONTRACTUAL	117,876,400	106,422,428	106,422,428	126,115,640	8,239,240	7.0%
AGENCIES & SUPPORT PAYMENTS	295,040,940	275,413,383	275,413,383	312,711,480	17,670,540	6.0%
RESERVES/RECOVERIES	35,921,070	42,971,157	42,971,157	46,380,770	10,459,700	29.1%
COST ALLOCATIONS	(7,225,070)	(7,095,318)	(7,095,318)	(7,678,480)	(453,410)	6.3%
FINANCIAL	44,340,290	43,516,283	43,516,283	48,706,780	4,366,490	9.8%
CAPITAL FINANCING	147,074,670	137,518,507	137,518,507	152,898,530	5,823,860	4.0%
CAPITAL EXPENDITURES	4,730	119,872	119,872	4,730	0	0.0%
RECOVERIES FROM CAPITAL	(34,678,090)	(33,270,457)	(33,270,457)	(33,208,230)	1,469,860	(4.2)%
TOTAL EXPENSES	1,374,145,990	1,352,756,994	1,352,756,994	1,473,383,640	99,237,650	7.2%
FEES & GENERAL	(197,560,950)	(184,332,911)	(184,332,911)	(208,040,780)	(10,479,830)	5.3%
TAX & RATES	(30,769,700)	(30,921,700)	(30,921,700)	(31,555,320)	(785,620)	2.6%
GRANTS & SUBSIDIES	(368,881,510)	(404,661,131)	(404,661,131)	(372,745,920)	(3,864,410)	1.0%
RESERVES	(53,718,010)	(34,401,277)	(34,401,277)	(99,411,240)	(45,693,230)	85.1%
TOTAL REVENUES	(650,930,170)	(654,317,019)	(654,317,019)	(711,753,260)	(60,823,090)	9.3%
NET LEVY	723,215,820	698,439,975	698,439,975	761,630,380	38,414,560	5.3%

**2022
Preliminary
Tax Supported
Operating Budget
Complement
Summary**

COMPLEMENT SUMMARY

PLANNING & ECONOMIC DEVELOPMENT

	2021 Approved Budget	2021 Restated Budget	2022 Preliminary Budget	2022 Preliminary vs. 2021 Restated	
				FTE	%
General Manager	7.00	7.00	7.00	0.00	0.0%
Transportation, Planning and Parking Building ²	139.24	140.24	140.24	0.00	0.0%
Economic Development	110.32	101.32	101.32	0.00	0.0%
Growth Management ⁴	46.99	46.99	46.99	0.00	0.0%
Licensing & By-Law Services ⁵	56.88	56.88	59.88	3.00	5.3%
Planning ^{1,2,3,5}	110.15	110.15	113.15	3.00	2.7%
Tourism & Culture	78.00	93.00	96.00	3.00	3.2%
	72.79	72.79	72.79	0.00	0.0%
Total Planning & Economic Development	621.37	628.37	637.37	9.00	1.4%

1. Approved to Restated: Planning Technologist (1 FTE) transferred from the Planning Division to the Transportation Planning & Parking Division Report # PED21151 approved at Council on July 9, 2021 as per Recommendation (c)
2. Approved to Restated: Transfer from Building to Planning : 15 FTEs (14 Zoning Examiner/Code Correlator, 1 Zoning Supervisor) as per PED21151, added 6 FTE in Building Enterprise under blanket authority (1 SPM, 1 Enf Building Inspector, 1 Bldg Engineer , 2 Supervisors and 1 Plans Examiner)
3. Approved to Restated: Added 1 FTE (SPM Digital Planning Applications) in Planning Division as per PED 21151 recommendation b)
4. Restated to Preliminary: Added 3 new FTEs (PM Construction, PM Development Eng, Development Coord) as per PED 21151 recommendation d) to f)
5. Restated to Preliminary: Added 3 FTEs in LBS (1 Licensing Administrator & 2 LCOs) & 3 FTEs in Planning (3 Zoning Exam/Code Corrltrts) as per PED21097(a)

COMPLEMENT SUMMARY

	2021 Approved Budget	2021 Restated Budget	2022 Preliminary Budget	2022 Preliminary vs. 2021 Restated	
				FTE	%

	2021 Approved Budget	2021 Restated Budget	2022 Preliminary Budget	2022 Preliminary vs. 2021 Restated FTE	%
HEALTHY AND SAFE COMMUNITIES					
HSC Administration ^{1,6}	32.50	35.50	36.50	1.00	2.8%
Children's Services & Neighbourhood Dev. ^{1,2}	94.00	87.00	87.00	0.00	0.0%
Ontario Works	210.00	210.00	210.00	0.00	0.0%
Housing Services ^{2,7}	54.00	58.00	58.00	0.00	0.0%
Long Term Care	451.55	451.55	451.55	0.00	0.0%
Recreation ⁸	449.23	449.24	448.98	(0.26)	(0.1)%
Hamilton Fire Department ⁹	595.30	595.30	599.30	4.00	0.7%
Hamilton Paramedic Service	358.36	358.36	358.36	0.00	0.0%
Public Health Services ^{3,4,5,10,11,12,13}	394.89	392.75	390.75	(2.00)	(0.5)%
Total Healthy and Safe Communities	2,639.83	2,637.70	2,640.44	2.74	0.1%

1. Approved to Restated: Transfer of 1.00 FTE Student Community Initiatives, 1.00 FTE Manager Indigenous Relations and 1.00 FTE Project Manager Indigenous Initiative from Children's Services & Neighbourhood Development to General Manager's Office.

2. Approved to Restated: Transfer of 4.00 FTE from Children's Services and Neighbourhood Development to Housing Services per HSC21032, 1.00 FTE Manager, 2.00 FTE Project Managers, and 1.00 FTE Program Secretary Pol/Prog Dev.

3. Approved to Restated: Decrease (2.25) FTE overall relating to decreases in Alcohol, Drug & Gambling Services, Mental Health and other funding sources as per BOH19001, BOH20016 and BOH21008. Balance adjusted to agree the final report BOH21008.

4. Approved to Restated: Increase of 0.61 FTE for Clinical Therapist in Child and Adolescent Services per BOH21010. FTE changes include (0.28) FTE reduction of receptionist and increase of 0.89 FTE clinical therapist.

5. Approved to Restated: 0.50 FTE is being transferred from Healthy Environments to Government Relations & Community Engagement division within CMO. This 0.50 FTE is from the one time Raccoon Rabies program (See Note 10).

6. Restated to Preliminary: Increase 1.00 FTE HSC19032(b) Senior Project Manager to lead a collaborative and coordinated community-wide implementation of Hamilton's Community Safety and Well-Being Plan.

7. Restated to Preliminary: Increase 1.00 FTE HSC21019 Status Change of Housing programs Officer Position and decrease (1.00) FTE HSC21032 Human Service Integration.

8. Restated to Preliminary: Decrease due to transfer of (0.26) FTE via base budget transfer to distribute the dual position FTE evenly between Recreation & Energy, Fleet & Facilities per FCS21070.

9. Restated to Preliminary: Increase 4.00 FTE Fire Inspectors for Rental Housing Pilot Project per PED 21097/LS21022. These are temporary FTEs.

10. Restated to Preliminary: Decrease (1.50) FTE One time Raccoon Rabies program no longer funded by ministry and will not be operating in 2022 (See Note 5).

11. Restated to Preliminary: Decrease (0.50) FTE due to termination of secondment agreement between Hamilton Family Health Team and PHS for a PHN ending January 8, 2021 confirmed in BOH13002(b).

COVID TEMPORARY FTE NOT INCLUDED IN ABOVE COMPLEMENT

12. 2021 Council approved and 2021 Restated: Excludes 110.24 Temporary COVID19 Response Related FTE funded through senior levels of government. Note: 287.60 FTE were added after 2021 budget was approved for COVID19 Vaccine program.

13. 2022 Preliminary: Excludes 484.70 temporary COVID19 Response Related FTE funded through senior levels of government

COMPLEMENT SUMMARY

	2021 Approved Budget	2021 Restated Budget	2022 Preliminary Budget	2022 Preliminary vs. 2021 Restated	
				FTE	%

	2021 Approved Budget	2021 Restated Budget	2022 Preliminary Budget	2022 Preliminary vs. 2021 Restated FTE	2022 Preliminary vs. 2021 Restated %
<u>PUBLIC WORKS</u>					
PW-General Administration	7.30	7.30	7.30	0.00	0.0%
Energy Fleet & Facilities ¹	181.95	181.95	182.21	0.26	0.1%
Engineering Services	123.33	123.33	123.33	0.00	0.0%
Environmental Services	394.64	394.64	394.64	0.00	0.0%
Transit ²	782.41	782.41	825.41	43.00	5.5%
Transportation Operations & Maintenance	406.71	406.71	406.71	0.00	0.0%
Waste Management	117.01	117.01	117.01	0.00	0.0%
Total Public Works	2,013.35	2,013.35	2,056.61	43.26	2.1%

1. Restated to Preliminary: Increase 0.26 FTE from HS&C to EFFM (approved under report FCS21070)

2. Restated to Preliminary: Increase by 43.0 FTE (Year 6 of Transit Strategy- Report PW14015(a))

	2021 Approved Budget	2021 Restated Budget	2022 Preliminary Budget	2022 Preliminary vs. 2021 Restated FTE	2022 Preliminary vs. 2021 Restated %
<u>LEGISLATIVE</u>					
Mayors Office	6.00	6.00	6.00	0.00	0.0%
Ward Budgets	16.00	16.00	16.00	0.00	0.0%
Total Legislative	22.00	22.00	22.00	0.00	0.0%

	2021 Approved Budget	2021 Restated Budget	2022 Preliminary Budget	2022 Preliminary vs. 2021 Restated FTE	2022 Preliminary vs. 2021 Restated %
<u>CITY MANAGER</u>					
Office of the City Auditor	7.00	7.00	7.00	0.00	0.0%
CMO - Admin	2.00	2.00	2.00	0.00	0.0%
Communication & Strategic Initiatives	22.00	22.00	22.00	0.00	0.0%
Digital & Innovation Office	5.00	5.00	5.00	0.00	0.0%
Government & Community Relations ¹	4.00	5.00	5.00	0.00	0.0%
Human Resources ^{2,3,4}	79.00	78.50	79.00	0.50	0.6%
Total City Manager	119.00	119.50	120.00	0.50	0.4%

1. 2021 Restated for Govt & Community Relations (FTE transfer from HR & HSC) to transfer the responsibilities to support equity seeking Council advisory groups to Gov't & Community Relations as per the recommendations from the external review of the City Manager's Office

2. 2021 Restated for HR (1/2 FTE transfer to Govt & Comm Relations)

3. 2022 Preliminary reduction due to end to temp program (HR Transgender Training)

4. 2022 Preliminary addition of 2.0 FTE for Equity, Diversity and Inclusion Framework per Report HUR19019(b)

COMPLEMENT SUMMARY

	2021 Approved Budget	2021 Restated Budget	2022 Preliminary Budget	2022 Preliminary vs. 2021 Restated	
				FTE	%
<u>CORPORATE SERVICES</u>					
City Clerk's Office	29.00	29.00	29.00	0.00	0.0%
Customer Service, POA and Fin'l Integration	93.47	93.47	93.47	0.00	0.0%
Financial Serv, Taxation and Corp Controller	80.00	80.00	80.00	0.00	0.0%
Legal Services and Risk Management ¹	67.00	67.00	72.00	5.00	7.5%
Corporate Services - Administration	2.00	2.00	2.00	0.00	0.0%
Financial Planning, Admin & Policy	83.58	83.58	83.58	0.00	0.0%
Information Technology	116.00	116.00	116.00	0.00	0.0%
Total Corporate Services	471.05	471.05	476.05	5.00	1.1%

1. 2022 Approved increase of 5 FTE based on report '2021 Property and Liability Insurance Renewal Report LS21027' to mitigate insurance costs

Corporate Financials - Expenditures¹	0.00	0.00	13.30	13.30	0.0%
--	-------------	-------------	--------------	--------------	-------------

1. Operating Impacts from Capital. 6.45 relates to Public Works, 5.5 FTE relates to Corporate Services, and 1.25 to Planning and Economic Development.

TOTAL CITY COMPLEMENT	5,886.60	5,891.97	5,965.77	73.80	1.3%
------------------------------	-----------------	-----------------	-----------------	--------------	-------------

<u>BOARDS & AGENCIES</u>						
Library ¹	291.61	291.61	297.00	5.39	1.8%	
Police Services ²	1,180.50	1,180.50	1,180.50	0.00	0.0%	
Farmers' Market	4.40	4.40	4.40	0.00	0.0%	
Total Boards & Agencies	1,476.51	1,476.51	1,481.90	5.39	0.4%	

1. Per Library Board approval.

2. The Police Services budget is approved by the Police Services Board. The Budget is scheduled to be submitted to the Board on December 16th, 2021.

TOTAL COMPLEMENT	7,363.11	7,368.48	7,447.67	79.19	1.1%
-------------------------	-----------------	-----------------	-----------------	--------------	-------------

**2022
Preliminary
Tax Supported
Operating Budget
Departmental
Budget
Summaries**

PLANNING AND ECONOMIC DEVELOPMENT

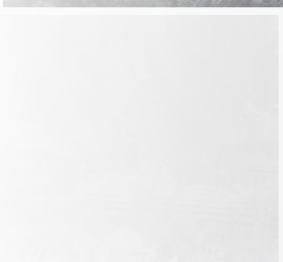
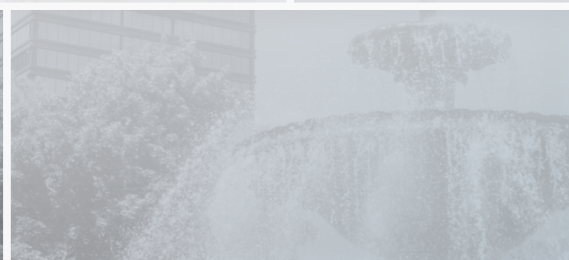
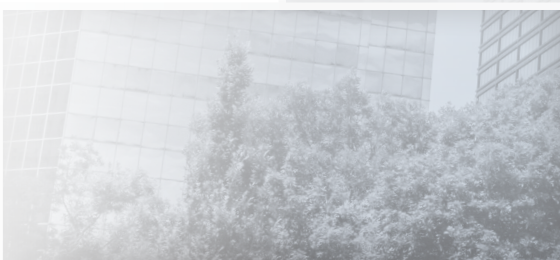
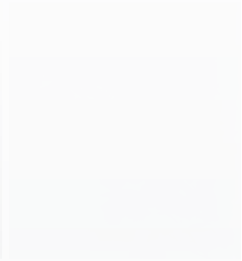
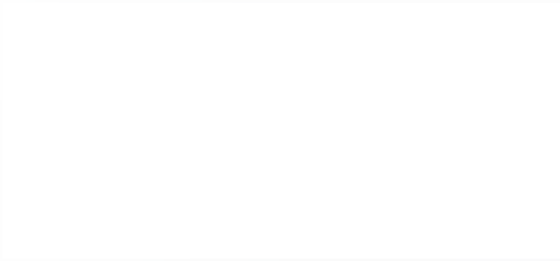

DEPARTMENT STRUCTURE

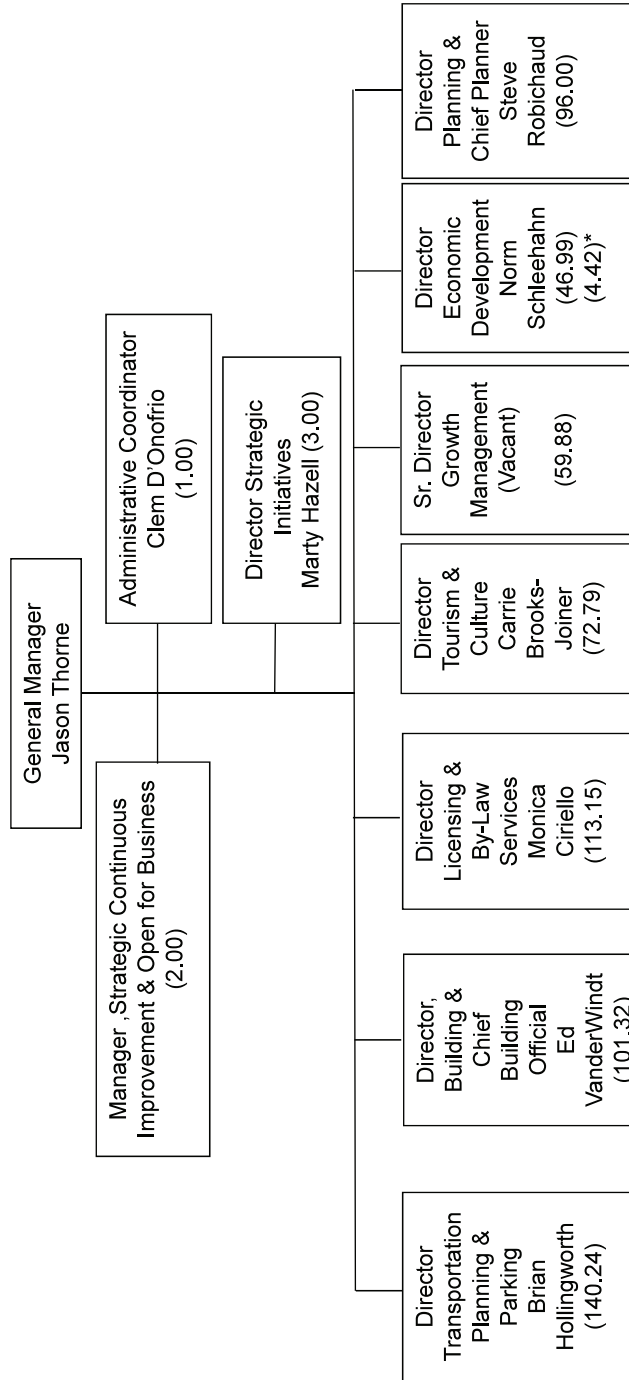

COMPLEMENT (FTE)	MANAGEMENT	* DISTRIBUTED MANAGEMENT	OTHER	* DISTRIBUTED OTHER	TOTAL	STAFF/MGT RATIO
2021	36.00	0.00	592.37	0.00	628.37	16.45:1
2022	37.00	1.00	604.79	3.42	646.21	16.00:1
CHANGE	1.00	1.00	12.42	3.42	17.84	0.45:1

* Denotes positions included in the complement, funded by the operating departments and appear in their budget

2022 Preliminary Tax Supported Operating Budget

BY DIVISION

	2021	2021	2021	2022	2022	2022 Preliminary Budget vs. 2021 Restated	
	Restated Gross	Restated Net	Projected Actual Net	Preliminary Budget Gross	Preliminary Budget Net	Change \$	Change %
General Manager PED	1,044,630	1,058,110	797,688	1,055,400	1,055,400	(2,710)	(0.3)%
Transportation, Planning and Parking Building	16,889,770	2,068,200	2,037,841	17,082,540	2,236,320	168,120	8.1%
Economic Development	15,228,660	617,440	1,161,083	15,634,620	607,620	(9,820)	(1.6)%
Growth Management	7,576,380	5,584,010	5,312,761	7,692,260	5,668,070	84,060	1.5%
Licensing & By-Law Services	6,706,040	490,160	25,553	7,256,930	463,430	(26,730)	(5.5)%
Planning	13,177,530	6,801,670	6,267,011	13,402,310	6,943,520	141,850	2.1%
Tourism & Culture	8,945,810	4,280,610	3,425,263	9,568,480	4,301,910	21,300	0.5%
Total Planning & Economic Development	10,527,190	9,489,530	9,306,647	10,719,240	9,703,790	214,260	2.3%
Total	80,096,010	30,389,730	28,333,847	82,411,780	30,980,060	590,330	1.9%

BY COST CATEGORY

	2021	2021	2022	2022 Preliminary Budget vs. 2021 Restated	
	Restated Budget	Projected Actual	Preliminary Budget	Change \$	Change %
EMPLOYEE RELATED COST	64,268,320	62,094,957	66,192,840	1,924,520	3.0%
MATERIAL & SUPPLY	2,164,880	2,110,363	2,261,380	96,500	4.5%
VEHICLE EXPENSES	558,500	591,934	592,980	34,480	6.2%
BUILDING & GROUND	2,247,050	2,232,984	2,178,670	(68,380)	(3.0)%
CONSULTING	251,530	362,838	248,130	(3,400)	(1.4)%
CONTRACTUAL	3,365,270	3,541,652	3,482,450	117,180	3.5%
AGENCIES & SUPPORT PAYMENTS	1,338,850	1,524,913	1,336,790	(2,060)	(0.2)%
RESERVES/RECOVERIES	6,030,680	13,211,653	5,989,720	(40,960)	(0.7)%
COST ALLOCATIONS	1,562,010	1,913,971	1,650,450	88,440	5.7%
FINANCIAL	2,336,750	2,349,080	2,337,920	1,170	0.1%
CAPITAL FINANCING	0	35,347	60,000	60,000	0.0%
CAPITAL EXPENDITURES	4,730	1,622	4,730	0	0.0%
RECOVERIES FROM CAPITAL	(4,032,560)	(3,036,517)	(3,924,280)	108,280	(2.7)%
TOTAL EXPENSES	80,096,010	86,934,797	82,411,780	2,315,770	2.9%
FEES & GENERAL	(42,494,800)	(43,971,781)	(49,311,610)	(6,816,810)	16.0%
GRANTS & SUBSIDIES	(1,241,510)	(12,350,581)	(874,690)	366,820	(29.5)%
RESERVES	(5,969,970)	(2,278,588)	(1,245,420)	4,724,550	(79.1)%
TOTAL REVENUES	(49,706,280)	(58,600,950)	(51,431,720)	(1,725,440)	3.5%
NET LEVY	30,389,730	28,333,847	30,980,060	590,330	1.9%

2023 To 2025 Multi-Year Outlook Gross and Net Operating Budget

BY DIVISION

	2022 Preliminary Budget Gross	2022 Preliminary Budget Net	2023 Preliminary Gross	2023 Preliminary Net	2024 Preliminary Gross	2024 Preliminary Net	2025 Preliminary Gross	2025 Preliminary Net
General Manager PED	1,055,400	1,055,400	1,083,540	1,083,540	1,106,520	1,106,520	1,125,140	1,125,140
Transportation, Planning and Parking	17,082,540	2,236,320	17,470,660	2,151,490	17,805,760	2,152,290	18,168,010	2,210,090
Building	15,634,620	607,620	16,076,400	645,090	16,464,300	668,070	16,790,170	697,370
Economic Development	7,692,260	5,668,070	7,856,120	5,824,690	7,996,730	5,960,180	8,105,790	6,076,650
Growth Management	7,256,930	463,430	7,500,450	593,810	7,699,960	676,400	7,864,040	736,310
Licensing & By-Law Services	13,402,310	6,943,520	13,702,940	7,201,880	13,702,860	7,418,990	13,978,890	7,638,470
Planning	9,568,480	4,301,910	9,867,160	4,478,780	9,809,020	4,607,900	9,960,460	4,688,730
Tourism & Culture	10,719,240	9,703,790	10,993,530	9,940,550	11,165,270	10,097,430	11,333,600	10,250,550
Total Planning & Economic Development	82,411,780	30,980,060	84,550,800	31,919,830	85,750,420	32,687,780	87,326,100	33,423,310

2022 Preliminary Tax Supported Operating Budget

BY SECTION - GENERAL MANAGER

	2021	2021	2021	2022	2022	2022 Preliminary Budget vs. 2021 Restated	
	Restated Gross	Restated Net	Projected Actual Net	Preliminary Budget Gross	Preliminary Budget Net	Change \$	Change %
Strategic Initiatives	385,190	385,190	276,748	388,370	388,370	3,180	0.8%
GM Office	659,440	672,920	520,940	667,030	667,030	(5,890)	(0.9)%
Total General Manager PED	1,044,630	1,058,110	797,688	1,055,400	1,055,400	(2,710)	(0.3)%

BY COST CATEGORY - GENERAL MANAGER

	2021	2021	2022	2022 Preliminary Budget vs. 2021 Restated	
	Restated Budget	Projected Actual	Preliminary Budget	Change \$	Change %
EMPLOYEE RELATED COST	1,068,820	839,923	1,117,590	48,770	4.6%
MATERIAL & SUPPLY	27,680	12,212	54,200	26,520	95.8%
BUILDING & GROUND	1,600	1,600	1,640	40	2.5%
CONTRACTUAL	13,520	6,673	13,520	0	0.0%
RESERVES/RECOVERIES	118,430	112,741	53,870	(64,560)	(54.5)%
COST ALLOCATIONS	(190,150)	(190,517)	(190,150)	0	0.0%
CAPITAL EXPENDITURES	4,730	1,576	4,730	0	0.0%
TOTAL EXPENSES	1,044,630	784,208	1,055,400	10,770	1.0%
RESERVES	13,480	13,480	0	(13,480)	(100.0)%
TOTAL REVENUES	13,480	13,480	0	(13,480)	(100.0)%
NET LEVY	1,058,110	797,688	1,055,400	(2,710)	(0.3)%

DIVISION STRUCTURE

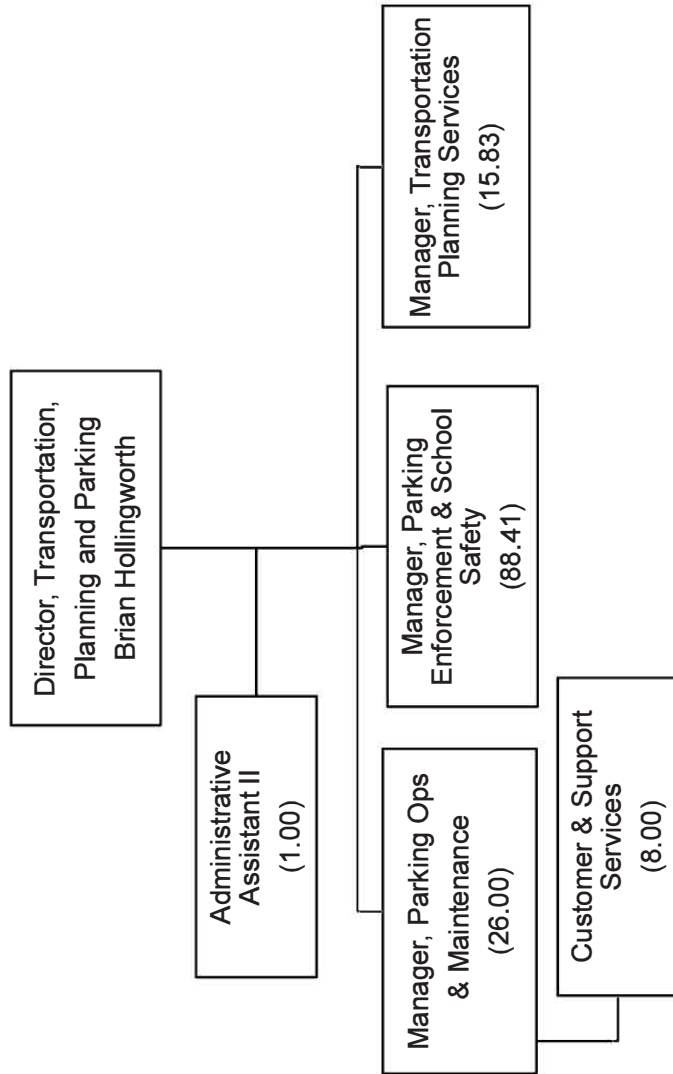

COMPLEMENT (FTE)	MANAGEMENT	OTHER	TOTAL	STAFF/MGT RATIO
2021	4.00	136.24	140.24	34.06:1
2022	4.00	136.24	140.24	34.06:1
CHANGE	0.00	0.00	0.00	

2022 Preliminary Tax Supported Operating Budget

BY SECTION

	2021	2021	2021	2022	2022	2022 Preliminary Budget vs. 2021 Restated	
	Restated Gross	Restated Net	Projected Actual Net	Preliminary Budget Gross	Preliminary Budget Net	Change \$	Change %
Transportation Planning	1,850,910	1,462,730	1,435,049	1,871,600	1,474,900	12,170	0.8%
Directors Office TPP	166,470	166,470	408,662	168,080	168,080	1,610	1.0%
Hamilton Municipal Parking System	12,959,320	(1,474,070)	(1,735,086)	13,058,400	(1,391,120)	82,950	(5.6)%
School Crossing	1,913,070	1,913,070	1,929,216	1,984,460	1,984,460	71,390	3.7%
Total Transportation Planning and Parking	16,889,770	2,068,200	2,037,841	17,082,540	2,236,320	168,120	8.1%

BYCOSTCATEGORY

	2021	2021	2022	2022 Preliminary Budget vs. 2021 Restated		
	Restated Budget	Projected Actual	Preliminary Budget	Change \$	Change %	
EMPLOYEE RELATED COST		10,160,280	10,298,008	10,302,040	141,760	1.4%
MATERIAL & SUPPLY		338,910	415,001	358,410	19,500	5.8%
VEHICLE EXPENSES		189,410	220,278	205,090	15,680	8.3%
BUILDING & GROUND		791,900	804,595	682,570	(109,330)	(13.8)%
CONSULTING		0	227	0	0	0.0%
CONTRACTUAL		1,600,150	1,585,513	1,679,090	78,940	4.9%
RESERVES/RECOVERIES		1,645,840	1,648,962	1,714,760	68,920	4.2%
COST ALLOCATIONS		749,960	756,617	792,580	42,620	5.7%
FINANCIAL		1,530,100	1,606,265	1,467,340	(62,760)	(4.1)%
RECOVERIES FROM CAPITAL		(116,780)	(70,729)	(119,340)	(2,560)	2.2%
TOTAL EXPENSES		16,889,770	17,264,737	17,082,540	192,770	1.1%
FEES & GENERAL		(11,754,240)	(5,719,199)	(14,846,220)	(3,091,980)	26.3%
RESERVES		(3,067,330)	(9,507,697)	0	3,067,330	(100.0)%
TOTAL REVENUES		(14,821,570)	(15,226,896)	(14,846,220)	(24,650)	0.2%
NET LEVY		2,068,200	2,037,841	2,236,320	168,120	8.1%

DIVISION STRUCTURE

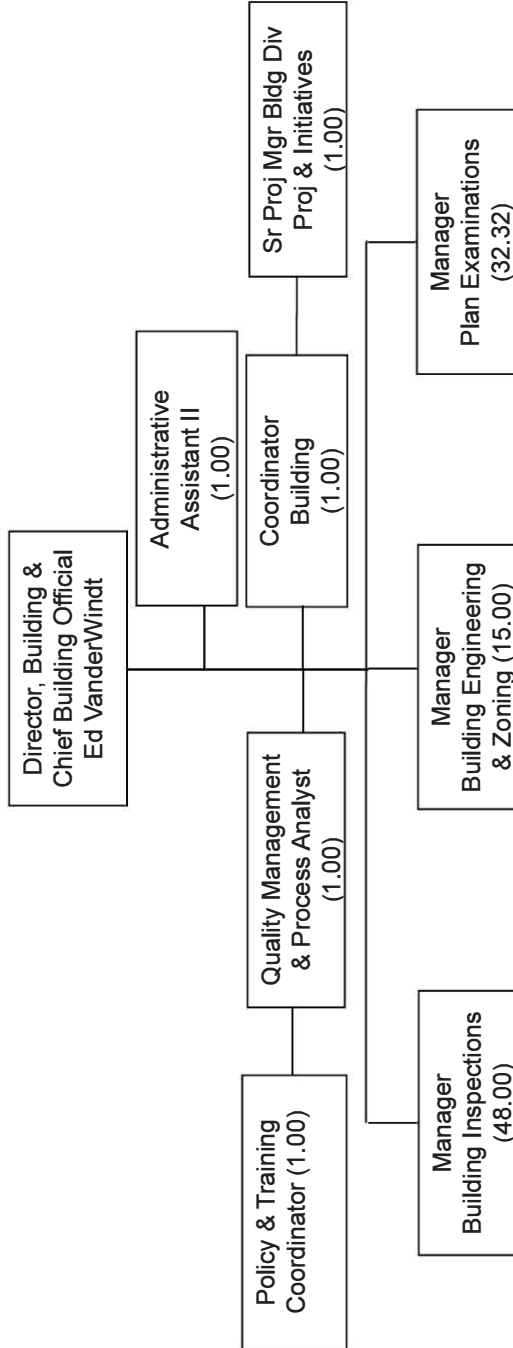

BUILDING

COMPLEMENT (FTE)	MANAGEMENT	OTHER	TOTAL	STAFF/MGT RATIO
2020	4.00	97.32	101.32	24.33:1
2022	4.00	97.32	101.32	24.33:1
CHANGE	0.00	0.00	0.00	

2022 Preliminary Tax Supported Operating Budget

BY SECTION

	2021	2021	2021	2022	2022	2022 Preliminary
	Restated Gross	Restated Net	Projected Actual Net	Preliminary Budget Gross	Preliminary Budget Net	Residual Change \$
ation - Building Serv	302,600	298,600	315,451	264,260	260,180	(38,420)
Inspections	628,510	628,510	621,600	649,190	649,190	20,680
ing & Zoning Services	121,210	(541,440)	0	131,460	(532,700)	8,740
ie Model	13,953,220	8,650	2	14,358,760	0	(8,650)
mination	223,120	223,120	224,030	230,950	230,950	7,830
ilding	15,228,660	617,440	1,161,083	15,634,620	607,620	(9,820)

BY COST CATEGORY

	2021	2021	2022	2022 Preliminary Budget vs. 2021 Restated	
	Restated Budget	Projected Actual	Preliminary Budget	Change \$	Change %
EMPLOYEE RELATED COST	12,148,310	12,938,065	12,414,930	266,620	2.2%
MATERIAL & SUPPLY	186,770	182,201	186,770	0	0.0%
VEHICLE EXPENSES	119,890	117,910	123,300	3,410	2.8%
BUILDING & GROUND	16,510	20,420	18,790	2,280	13.8%
CONSULTING	0	52,000	0	0	0.0%
CONTRACTUAL	54,890	103,110	54,890	0	0.0%
RESERVES/RECOVERIES	1,126,510	1,353,080	1,234,370	107,860	9.6%
COST ALLOCATIONS	1,524,280	1,345,020	1,550,070	25,790	1.7%
FINANCIAL	51,500	162,210	51,500	0	0.0%
RECOVERIES FROM CAPITAL	0	(260)	0	0	0.0%
TOTAL EXPENSES	15,228,660	16,273,756	15,634,620	405,960	2.7%
FEES & GENERAL	(14,469,100)	(15,112,673)	(15,027,000)	(557,900)	3.9%
RESERVES	(142,120)	0	0	142,120	(100.0)%
TOTAL REVENUES	(14,611,220)	(15,112,673)	(15,027,000)	(415,780)	2.8%
NET LEVY	617,440	1,161,083	607,620	(9,820)	(1.6)%

DIVISION STRUCTURE

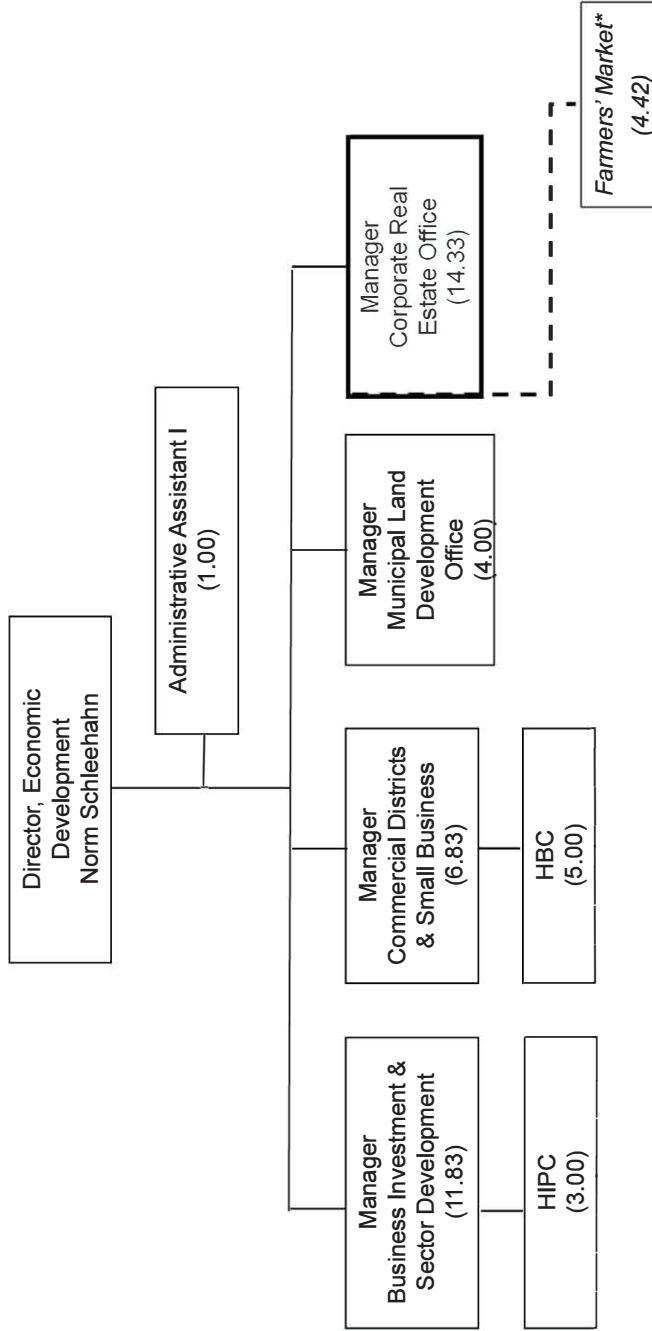

COMPLEMENT (FTE)	MANAGEMENT	* DISTRIBUTED MANAGEMENT	OTHER	* DISTRIBUTED OTHER	TOTAL	STAFF/MGT RATIO
2021	5.00	0.00	41.99	0.00	46.99	8.40:1
2022	5.00	1.00	41.99	3.42	51.41	7.57:1
CHANGE	0.00	1.00	0.00	3.42	4.42	0.83:1

*Distributed staff represent a direct reporting structure to Chief Corporate Real Estate Officer (Ray Kessler) of Hamilton Market employees. Hamilton Market budget resides in Boards and Agencies

2022 Preliminary Tax Supported Operating Budget

BY SECTION

	2021	2021	2021	2022	2022	2022 Preliminary Budget vs. 2021 Restated	
	Restated Gross	Restated Net	Projected Actual Net	Preliminary Budget Gross	Preliminary Budget Net	Change \$	Change %
Corporate Real Estate Office	728,160	725,820	726,012	782,970	780,630	54,810	7.6%
Commercial Districts and Small Business	3,240,650	1,636,620	1,639,618	3,305,560	1,700,020	63,400	3.9%
Municipal Land Development	229,570	229,570	178,626	225,040	225,040	(4,530)	(2.0)%
Business Development	3,378,000	2,992,000	2,768,505	3,378,690	2,962,380	(29,620)	(1.0)%
Total Economic Development	7,576,380	5,584,010	5,312,761	7,692,260	5,668,070	84,060	1.5%

BY COST CATEGORY

	2021	2021	2022	2022 Preliminary Budget vs. 2021 Restated		
	Restated Budget	Projected Actual	Preliminary Budget	Change \$	Change %	
EMPLOYEE RELATED COST		6,316,880	5,908,598	6,551,640	234,760	3.7%
MATERIAL & SUPPLY		254,670	244,459	261,020	6,350	2.5%
BUILDING & GROUND		11,190	19,653	12,850	1,660	14.8%
CONSULTING		19,650	39,788	23,900	4,250	21.6%
CONTRACTUAL		448,270	455,061	439,690	(8,580)	(1.9)%
AGENCIES & SUPPORT PAYMENTS		1,058,600	1,325,635	1,058,600	0	0.0%
RESERVES/RECOVERIES		323,750	1,038,759	279,650	(44,100)	(13.6)%
COST ALLOCATIONS		352,470	333,595	356,190	3,720	1.1%
FINANCIAL		501,420	300,986	486,690	(14,730)	(2.9)%
RECOVERIES FROM CAPITAL		(1,710,520)	(917,966)	(1,777,970)	(67,450)	3.9%
TOTAL EXPENSES		7,576,380	8,748,568	7,692,260	115,880	1.5%
FEES & GENERAL		(274,960)	(785,051)	(276,470)	(1,510)	0.5%
GRANTS & SUBSIDIES		(624,250)	(763,033)	(654,560)	(30,310)	4.9%
RESERVES		(1,093,160)	(1,887,723)	(1,093,160)	0	0.0%
TOTAL REVENUES		(1,992,370)	(3,435,807)	(2,024,190)	(31,820)	1.6%
NET LEVY		5,584,010	5,312,761	5,668,070	84,060	1.5%

DIVISION STRUCTURE

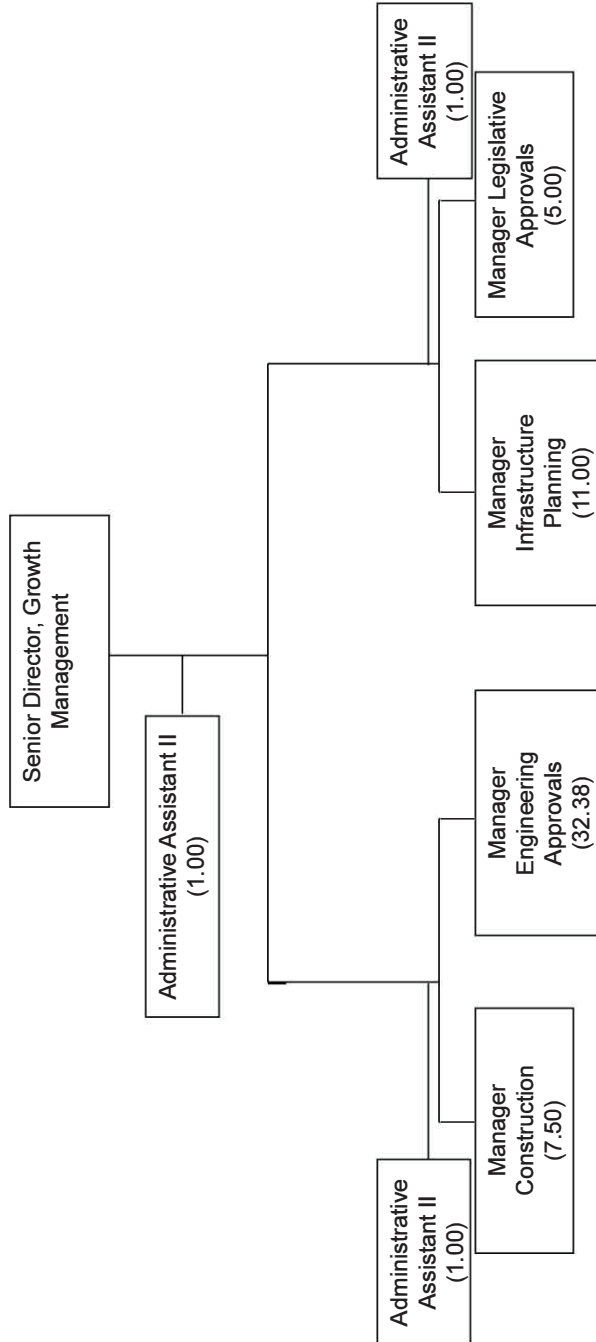

COMPLEMENT (FTE)	MANAGEMENT	OTHER	TOTAL	STAFF/MGT RATIO
2021	6.00	50.88	56.88	8.48:1
2022	6.00	53.88	59.88	8.98:1
CHANGE	0.00	3.00	3.00	

2022 Preliminary Tax Supported Operating Budget

BY SECTION

	2021	2021	2021	2022	2022	2022 Preliminary Budget vs. 2021 Restated	
	Restated Gross	Restated Net	Projected Actual Net	Preliminary Budget Gross	Preliminary Budget Net	Change \$	Change %
Director & Admin Growth Management	(92,820)	(92,820)	(163,547)	(13,440)	(13,440)	79,380	(85.5)%
Development Engineering	3,958,080	(632,830)	(1,259,180)	4,169,670	(736,640)	(103,810)	16.4%
Grading & Construction	765,520	150,550	131,370	962,380	135,190	(15,360)	(10.2)%
Infrastructure Planning	1,510,990	500,990	741,210	1,510,430	450,430	(50,560)	(10.1)%
Legislative Approvals	564,270	564,270	575,700	627,890	627,890	63,620	11.3%
Total Growth Management	6,706,040	490,160	25,553	7,256,930	463,430	(26,730)	(5.5)%

BY COST CATEGORY

	2021	2021	2022	2022 Preliminary Budget vs. 2021 Restated	
	Restated Budget	Projected Actual	Preliminary Budget	Change \$	Change %
EMPLOYEE RELATED COST	6,660,780	6,260,280	7,134,160	473,380	7.1%
MATERIAL & SUPPLY	156,320	80,333	156,320	0	0.0%
VEHICLE EXPENSES	30,500	26,550	35,310	4,810	15.8%
BUILDING & GROUND	9,560	9,560	9,410	(150)	(1.6)%
CONSULTING	70,000	108,980	70,000	0	0.0%
CONTRACTUAL	10,270	77,240	11,580	1,310	12.8%
RESERVES/RECOVERIES	641,660	4,983,460	706,230	64,570	10.1%
COST ALLOCATIONS	(564,910)	(664,910)	(563,510)	1,400	(0.2)%
FINANCIAL	17,170	30,210	28,170	11,000	64.1%
CAPITAL FINANCING	0	30,000	0	0	0.0%
RECOVERIES FROM CAPITAL	(325,310)	(325,310)	(330,740)	(5,430)	1.7%
TOTAL EXPENSES	6,706,040	10,616,393	7,256,930	550,890	8.2%
FEES & GENERAL	(5,720,380)	(10,039,190)	(6,793,500)	(1,073,120)	18.8%
RESERVES	(495,500)	(551,650)	0	495,500	(100.0)%
TOTAL REVENUES	(6,215,880)	(10,590,840)	(6,793,500)	(577,620)	9.3%
NET LEVY	490,160	25,553	463,430	(26,730)	(5.5)%

LICENSING AND BY-LAW SERVICES

DIVISION STRUCTURE

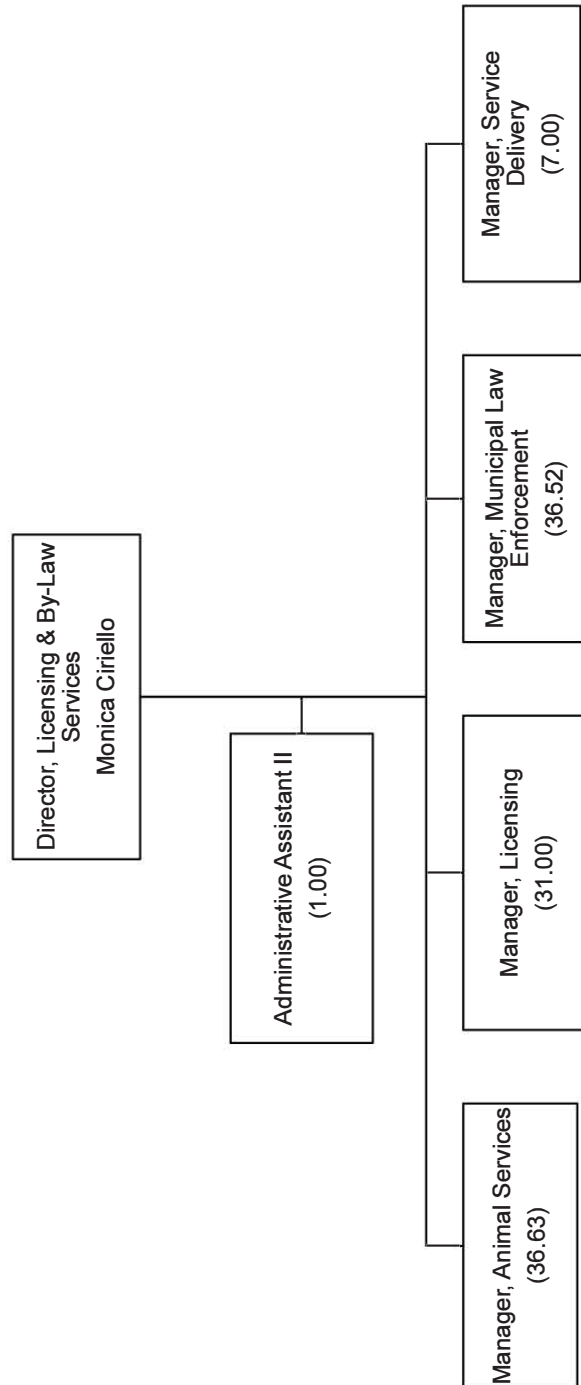

COMPLEMENT (FTE)	MANAGEMENT	OTHER	TOTAL	STAFF/MGT RATIO
2021	5.00	105.15	110.15	21.03:1
2022	5.00	108.15	113.15	21.63:1
CHANGE	0.00	3.00	3.00	

2022 Preliminary Tax Supported Operating Budget

BY SECTION

	2021	2021	2021	2022	2022	2022 Preliminary Budget vs. 2021 Restated	
	Restated Gross	Restated Net	Projected Actual Net	Preliminary Budget Gross	Preliminary Budget Net	Change \$	Change %
Service Delivery	671,910	671,910	677,136	669,320	669,320	(2,590)	(0.4)%
Animal Services	4,631,850	2,954,840	2,934,793	4,712,890	3,002,420	47,580	1.6%
Directors Office L&BL	591,460	599,570	761,715	594,300	594,300	(5,270)	(0.9)%
Licensing	3,195,810	(516,830)	(938,703)	3,224,700	(529,300)	(12,470)	2.4%
Municipal Law Enforcement	4,086,500	3,092,180	2,832,070	4,201,100	3,206,780	114,600	3.7%
Total Licensing & By-Law Services	13,177,530	6,801,670	6,267,011	13,402,310	6,943,520	141,850	2.1%

BY COST CATEGORY

	2021	2021	2022	2022 Preliminary Budget vs. 2021 Restated	
	Restated Budget	Projected Actual	Preliminary Budget	Change \$	Change %
EMPLOYEE RELATED COST		10,569,890	10,654,518	10,523,620	(46,270) (0.4)%
MATERIAL & SUPPLY		385,650	406,546	405,300	19,650 5.1%
VEHICLE EXPENSES		212,850	223,095	223,320	10,470 4.9%
BUILDING & GROUND		499,550	495,678	502,950	3,400 0.7%
CONSULTING		28,500	41,988	30,350	1,850 6.5%
CONTRACTUAL		158,390	358,565	163,430	5,040 3.2%
RESERVES/RECOVERIES		820,880	837,345	958,980	138,100 16.8%
COST ALLOCATIONS		411,020	411,164	408,860	(2,160) (0.5)%
FINANCIAL		90,800	118,721	125,500	34,700 38.2%
CAPITAL FINANCING		0	0	60,000	60,000 0.0%
TOTAL EXPENSES		13,177,530	13,547,620	13,402,310	224,780 1.7%
FEES & GENERAL		(5,924,830)	(5,860,297)	(6,454,790)	(529,960) 8.9%
GRANTS & SUBSIDIES		(403,130)	(1,252,115)	(4,000)	399,130 (99.0)%
RESERVES		(47,900)	(168,197)	0	47,900 (100.0)%
TOTAL REVENUES		(6,375,860)	(7,280,609)	(6,458,790)	(82,930) 1.3%
NET LEVY		6,801,670	6,267,011	6,943,520	141,850 2.1%

DIVISION STRUCTURE

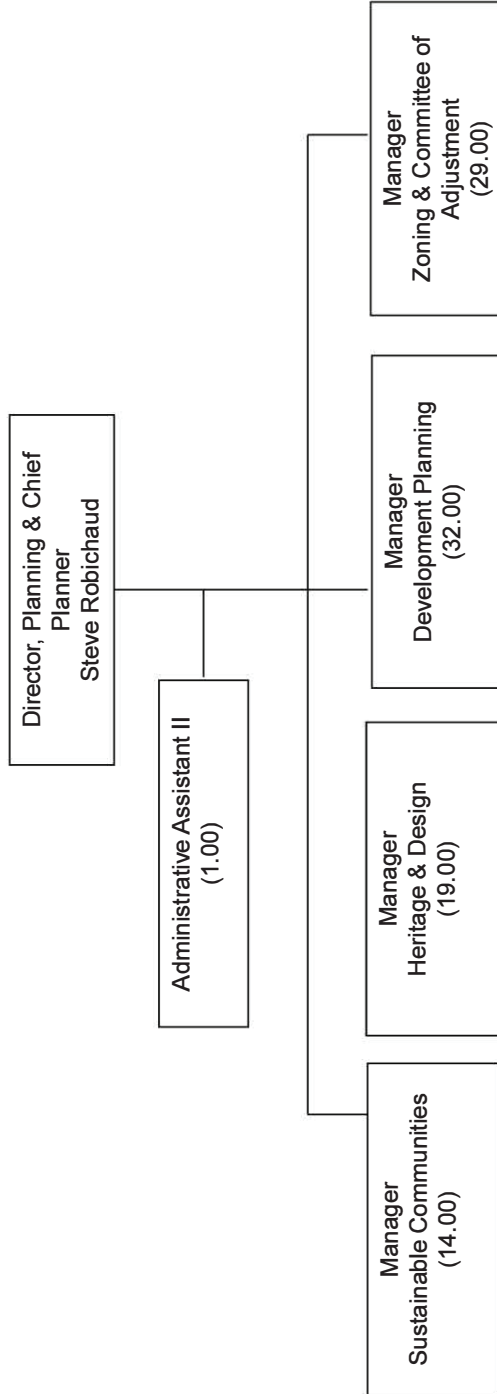

PLANNING

COMPLEMENT (FTE)	MANAGEMENT	OTHER	TOTAL	STAFF/MGT RATIO
2021	4.00	89.00	93.00	22.25:1
2022	4.00	92.00	96.00	23.00:1
CHANGE	0.00	3.00	3.00	

2022 Preliminary Tax Supported Operating Budget

BY SECTION

	2021	2021	2021	2022	2022	2022 Preliminary Budget vs. 2021 Restated	
	Restated Gross	Restated Net	Projected Actual Net	Preliminary Budget Gross	Preliminary Budget Net	Change \$	Change %
Sustainable Communities	951,380	951,380	809,700	983,060	983,060	31,680	3.3%
Zoning & Committee of Adjmt	1,426,430	552,600	(698,110)	1,874,440	306,320	(246,280)	(44.6)%
Development Planning	3,680,530	(106,840)	1,383,818	3,489,940	(204,430)	(97,590)	91.3%
Director & Admin Planning	975,500	975,500	1,147,945	1,052,600	1,052,600	77,100	7.9%
Heritage & Urban Design	1,911,970	1,907,970	781,910	2,168,440	2,164,360	256,390	13.4%
Total Planning	8,945,810	4,280,610	3,425,263	9,568,480	4,301,910	21,300	0.5%

BY COST CATEGORY

	2021	2021	2022	2022 Preliminary Budget vs. 2021 Restated	
	Restated Budget	Projected Actual	Preliminary Budget	Change \$	Change %
EMPLOYEE RELATED COST	9,577,810	7,542,392	10,292,790	714,980	7.5%
MATERIAL & SUPPLY	219,020	285,040	223,200	4,180	1.9%
VEHICLE EXPENSES	1,500	-	1,500	0	0.0%
BUILDING & GROUND	17,180	14,780	17,530	350	2.0%
CONSULTING	114,380	100,000	114,380	0	0.0%
CONTRACTUAL	73,140	94,610	72,620	(520)	(0.7)%
AGENCIES & SUPPORT PAYMENTS	93,000	18,000	90,940	(2,060)	(2.2)%
RESERVES/RECOVERIES	844,620	2,729,320	566,660	(277,960)	(32.9)%
COST ALLOCATIONS	(774,780)	(140,340)	(786,590)	(11,810)	1.5%
FINANCIAL	56,770	37,000	62,770	6,000	10.6%
RECOVERIES FROM CAPITAL	(1,276,830)	(1,054,349)	(1,087,320)	189,510	(14.8)%
TOTAL EXPENSES	8,945,810	9,626,453	9,568,480	622,670	7.0%
FEES & GENERAL	(3,778,350)	(6,177,190)	(5,242,570)	(1,464,220)	38.8%
RESERVES	(886,850)	(24,000)	(24,000)	862,850	(97.3)%
TOTAL REVENUES	(4,665,200)	(6,201,190)	(5,266,570)	(601,370)	(12.9)%
NET LEVY	4,280,610	3,425,263	4,301,910	21,300	0.5%

DIVISION STRUCTURE

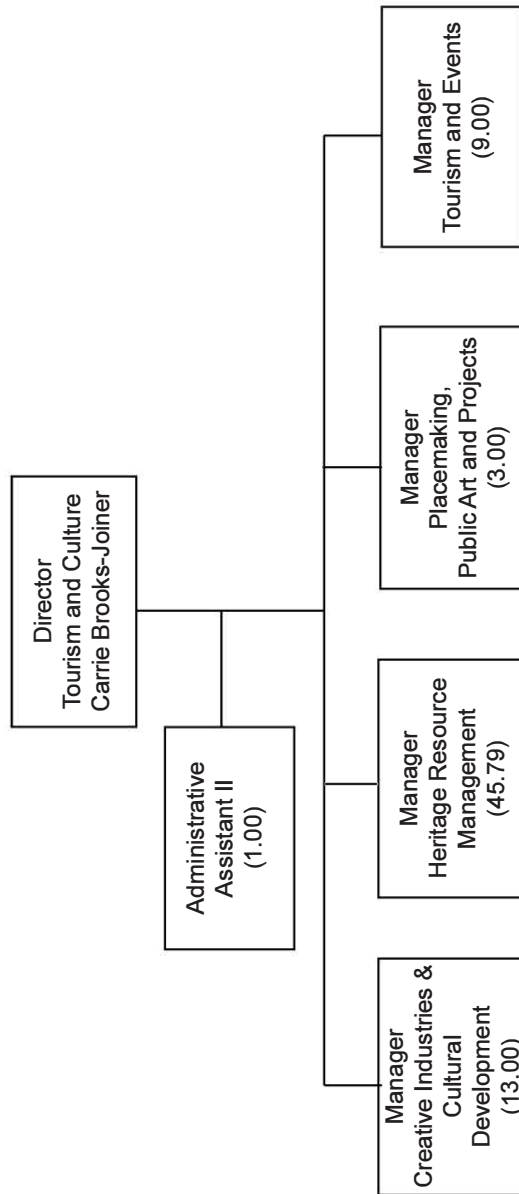

COMPLEMENT (FTE)	MANAGEMENT	OTHER	TOTAL	STAFF/MGT RATIO
2021	5.00	67.79	72.79	13.56:1
2022	5.00	67.79	72.79	13.56:1
CHANGE	0.00	0.00	0.00	

2022 Preliminary Tax Supported Operating Budget

BY SECTION

	2021	2021	2021	2022	2022	2022 Preliminary vs. 2021 Restated	
	Restated Gross	Restated Net	Projected Actual Net	Preliminary Gross	Preliminary Net	Change \$	Change %
Place Making, Public Arts and Projects	695,290	682,990	8,751,160	698,740	683,840	850	0.1%
Creative Industries and Cultural Development	1,828,970	1,749,500	0	1,820,390	1,740,920	(8,580)	(0.5)%
Heritage Resource Management	5,704,420	4,884,890	0	5,860,440	5,066,190	181,300	3.7%
Tourism	1,592,830	1,466,470	0	1,623,370	1,496,530	30,060	2.0%
Directors Office T&C	705,680	705,680	634,860	716,310	716,310	10,630	1.5%
Total Tourism & Culture	10,527,190	9,489,530	9,386,020	10,719,250	9,703,790	214,260	2.3%

BY COST CATEGORY

	2021	2021	2022	2022 Preliminary Budget vs. 2021 Restated		
	Restated	Budget	Projected Actual	Preliminary Budget	Change \$	Change %
EMPLOYEE RELATED COST		7,765,550	7,653,164	7,856,060	90,510	1.2%
MATERIAL & SUPPLY		595,860	484,571	616,160	20,300	3.4%
VEHICLE EXPENSES		4,350	4,100	4,460	110	2.5%
BUILDING & GROUND		899,560	866,698	932,930	33,370	3.7%
CONSULTING		19,000	19,000	9,500	(9,500)	(50.0)%
CONTRACTUAL		1,006,640	861,734	1,047,630	40,990	4.1%
AGENCIES & SUPPORT PAYMENTS		187,250	181,278	187,250	0	0.0%
RESERVES/RECOVERIES		508,990	(64,469)	475,200	(33,790)	(6.6)%
COST ALLOCATIONS		54,120	63,341	83,010	28,890	53.4%
FINANCIAL		88,990	93,687	115,950	26,960	30.3%
RECOVERIES FROM CAPITAL		(603,120)	(90,055)	(608,910)	(5,790)	1.0%
TOTAL EXPENSES		10,527,190	10,073,049	10,719,240	192,050	1.8%
FEES & GENERAL		(572,940)	(278,181)	(671,060)	(98,120)	17.1%
GRANTS & SUBSIDIES		(214,130)	(474,671)	(216,130)	(2,000)	0.9%
RESERVES		(250,590)	(13,550)	(128,260)	122,330	(48.8)%
TOTAL REVENUES		(1,037,660)	(766,402)	(1,015,450)	22,210	(2.1)%
NET LEVY		9,489,530	9,306,647	9,703,790	214,260	2.3%

HEALTHY AND SAFE COMMUNITIES

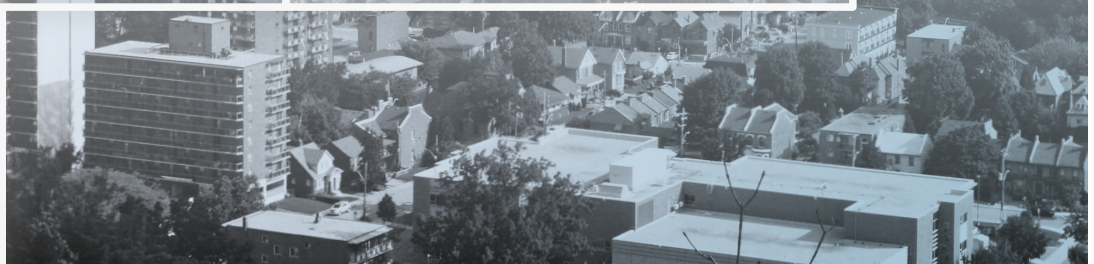
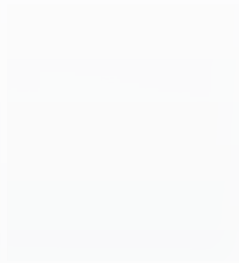
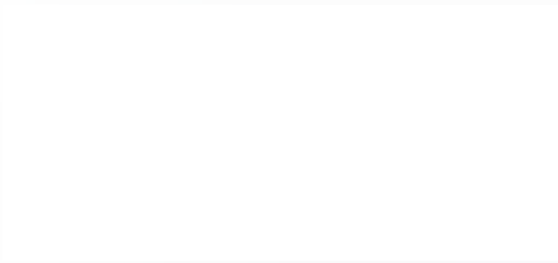

DEPARTMENT STRUCTURE

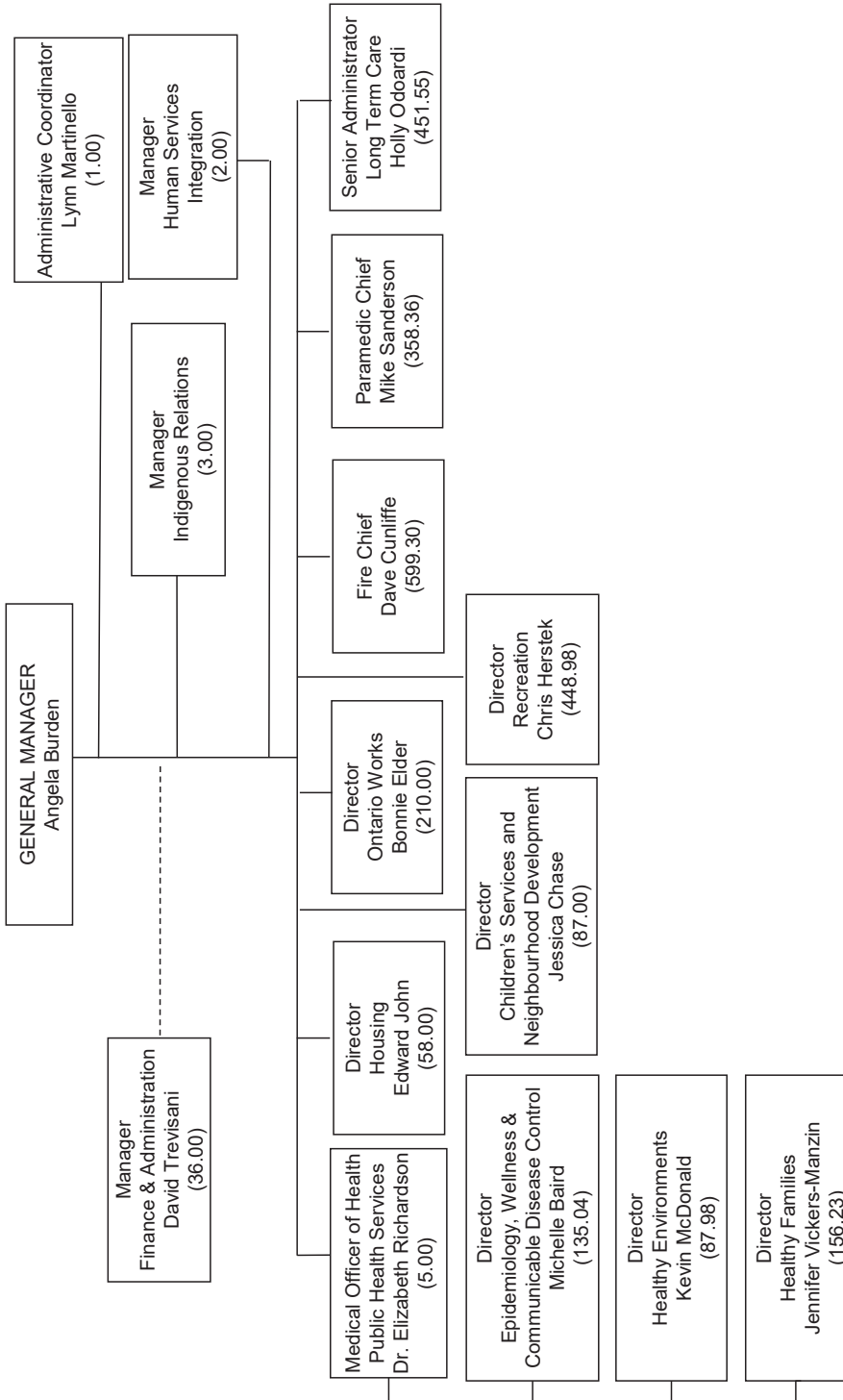

COMPLEMENT (FTE)	MANAGEMENT	OTHER	TOTAL	STAFF/MGT RATIO
2021	83.00	2,554.70	2,637.70	30.78:1
2022	84.00	2,556.44	2,640.44	30.43:1
CHANGE	1.00	1.74	2.74	

2022 Preliminary Tax Supported Operating Budget

BY DIVISION

	2021	2021	2021	2022	2022	2022 Preliminary Budget vs. 2021 Restated	
	Restated Gross	Restated Net	Projected Actual Net	Preliminary Budget Gross	Preliminary Budget Net	Change \$	Change %
HSC Administration	3,836,940	3,363,130	3,388,620	4,044,840	3,589,980	226,850	6.7%
Childrens Services and Neighbourhood Dev.	93,083,390	10,439,330	10,542,420	95,869,880	10,482,510	43,180	0.4%
Ontario Works	145,377,470	12,321,930	10,327,420	145,674,520	12,842,140	520,210	4.2%
Housing Services	97,654,960	47,325,860	43,215,360	120,331,290	53,937,500	6,611,640	14.0%
Long Term Care	44,818,490	11,524,860	9,447,360	47,010,500	11,768,320	243,460	2.1%
Recreation	54,777,680	35,319,640	35,263,950	55,975,450	35,988,570	668,930	1.9%
Hamilton Fire Department	95,338,160	93,288,450	93,073,760	99,031,680	97,526,440	4,237,990	4.5%
Hamilton Paramedic Service	61,497,880	28,102,490	30,317,940	64,184,740	28,395,390	292,900	1.0%
Public Health Services	68,774,000	13,503,920	13,099,630	101,606,170	14,339,300	835,380	6.2%
Total Healthy & Safe Communities	665,158,970	255,189,610	248,676,460	733,729,070	268,870,150	13,680,540	5.4%

BY COST CATEGORY

	2021	2021	2022	2022 Preliminary Budget vs. 2021 Restated	
	Restated Budget	Projected Actual	Preliminary Budget	Change \$	Change %
EMPLOYEE RELATED COST	304,092,680	316,211,820	340,166,040	36,073,360	11.9%
MATERIAL & SUPPLY	14,264,280	17,341,710	18,575,950	4,311,670	30.2%
VEHICLE EXPENSES	2,755,920	2,840,420	3,117,900	361,980	13.1%
BUILDING & GROUND	13,869,250	14,924,540	16,343,090	2,473,840	17.8%
CONSULTING	55,790	79,050	615,790	560,000	1003.8%
CONTRACTUAL	8,734,210	9,318,860	8,777,570	43,360	0.5%
AGENCIES & SUPPORT PAYMENTS	293,633,540	273,827,420	311,306,140	17,672,600	6.0%
RESERVES/RECOVERIES	19,351,670	19,030,060	22,827,320	3,475,650	18.0%
COST ALLOCATIONS	5,896,160	6,056,540	6,373,610	477,450	8.1%
FINANCIAL	2,923,200	2,967,220	4,112,230	1,189,030	40.7%
CAPITAL FINANCING	1,018,740	1,018,750	2,269,530	1,250,790	122.8%
CAPITAL EXPENDITURES	0	118,250	0	0	0.0%
RECOVERIES FROM CAPITAL	(1,436,450)	(1,069,950)	(756,100)	680,350	47.4%
TOTAL EXPENSES	665,158,990	662,664,690	733,729,070	68,570,080	10.3%
FEES & GENERAL	(30,828,780)	(34,256,300)	(31,681,450)	(852,670)	(2.8)%
GRANTS & SUBSIDIES	(348,730,120)	(364,711,100)	(353,163,350)	(4,433,230)	(1.3)%
RESERVES	(30,410,460)	(15,020,830)	(80,014,130)	(49,603,670)	(163.1)%
TOTAL REVENUES	(409,969,360)	(413,988,230)	(464,858,930)	(54,889,570)	(13.4)%
NET LEVY	255,189,630	248,676,460	268,870,140	13,680,510	5.4%

2022 Preliminary Tax Supported Operating Budget Multi-Year Budget Outlook

BY DIVISION

	2022 Preliminary Budget Gross	2022 Preliminary Budget Net	2023 Preliminary Gross	2023 Preliminary Net	2024 Preliminary Gross	2024 Preliminary Net	2025 Preliminary Gross	2025 Preliminary Net
HSC Administration	4,044,840	3,589,980	3,966,890	3,567,520	4,034,330	3,674,340	4,127,010	3,766,810
Childrens Services and Neighbourhood Dev.	95,869,880	10,482,510	98,282,780	12,121,770	98,515,750	12,354,420	98,734,620	12,573,290
Ontario Works	145,674,520	12,842,140	146,171,810	13,446,470	146,737,970	14,012,040	147,287,060	14,560,500
Housing Services	120,331,290	53,937,500	97,997,040	56,832,580	99,772,210	59,711,490	101,478,920	63,267,860
Long Term Care	47,010,500	11,768,320	46,644,540	11,675,830	47,336,910	12,539,890	48,105,330	13,284,700
Recreation	55,975,450	35,988,570	56,819,430	36,382,710	57,721,260	36,796,270	58,747,510	37,321,850
Hamilton Fire Department	99,031,680	97,526,440	101,540,140	100,436,130	104,221,920	103,564,410	107,527,460	106,850,450
Hamilton Paramedic Service	64,184,740	28,395,390	63,200,900	29,006,660	63,111,120	29,704,010	64,029,820	30,444,390
Public Health Services	101,606,170	14,339,300	104,029,960	17,528,130	57,352,630	18,431,130	58,247,080	19,327,510
Total Healthy & Safe Communities	733,729,070	268,870,150	718,653,490	280,997,800	678,804,100	290,788,000	688,284,810	301,397,360

2022 Preliminary Tax Supported Operating Budget

BY SECTION - ADMINISTRATION

	2021	2021	2021	2022	2022	2022 Preliminary Budget vs. 2021 Restated	
	Restated Gross	Restated Net	Projected Actual Net	Preliminary Budget Gross	Preliminary Budget Net	Change \$	Change %
HSC - Finance & Administration	2,593,580	2,155,820	2,087,320	2,623,490	2,204,680	48,860	2.3%
General Managers Office	1,243,360	1,207,310	1,301,300	1,421,350	1,385,300	177,990	14.7%
Total HSC Administration	3,836,940	3,363,130	3,388,620	4,044,840	3,589,980	226,850	6.7%

BY COST CATEGORY - ADMINISTRATION

	2021	2021	2022	2022 Preliminary Budget vs. 2021 Restated	
	Restated Budget	Projected Actual	Preliminary Budget	Change \$	Change %
EMPLOYEE RELATED COST	3,214,580	3,247,860	3,433,550	218,970	6.8%
MATERIAL & SUPPLY	226,100	193,540	226,110	10	0.0%
BUILDING & GROUND	6,240	6,670	6,720	480	7.7%
CONSULTING	0	14,250	0	0	0.0%
CONTRACTUAL	7,550	11,180	8,340	790	10.5%
AGENCIES & SUPPORT PAYMENTS	152,700	151,700	152,700	0	0.0%
RESERVES/RECOVERIES	194,150	189,040	181,170	(12,980)	(6.7)%
COST ALLOCATIONS	31,320	31,320	31,950	630	2.0%
FINANCIAL	4,300	4,150	4,300	0	0.0%
TOTAL EXPENSES	3,836,940	3,849,710	4,044,840	207,900	5.4%
GRANTS & SUBSIDIES	(348,490)	(461,090)	(349,110)	(620)	(0.2)%
RESERVES	(125,320)	0	(105,750)	19,570	15.6%
TOTAL REVENUES	(473,810)	(461,090)	(454,860)	18,950	4.0%
NET LEVY	3,363,130	3,388,620	3,589,980	226,850	6.7%

DIVISION STRUCTURE

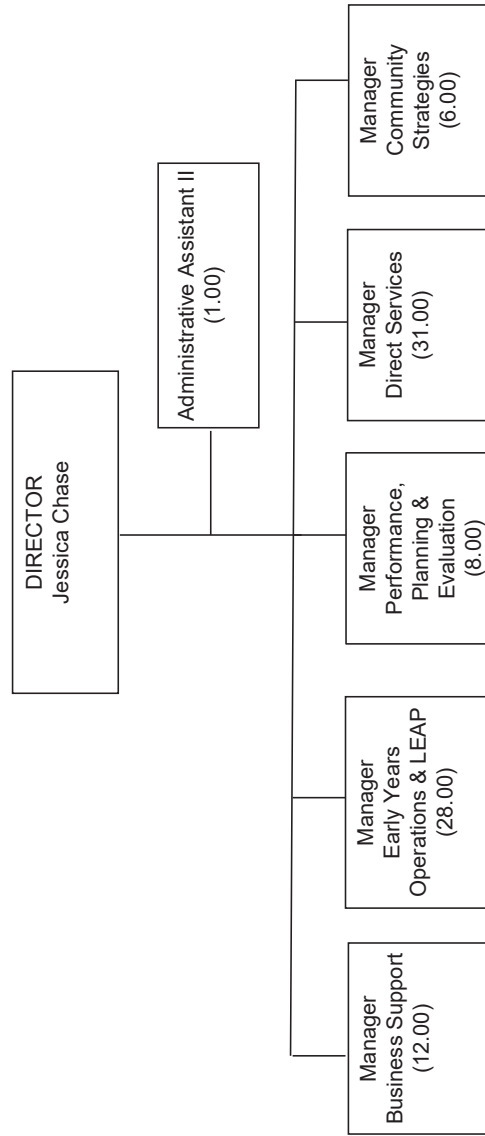

COMPLEMENT (FTE)	MANAGEMENT	OTHER	TOTAL	STAFF/MGT RATIO
2021	6.00	81.00	87.00	13.50:1
2022	6.00	81.00	87.00	13.50:1
CHANGE	0.00	0.00	0.00	

2022 Preliminary Tax Supported Operating Budget

BY SECTION

	2021	2021	2021	2022	2022	2022 Preliminary Budget vs. 2021 Restated	
	Restated Gross	Restated Net	Projected Actual Net	Preliminary Budget Gross	Preliminary Budget Net	Change \$	Change %
Neighbourhoods & Community	940,230	907,980	1,470,800	952,190	919,940	11,960	1.3%
CSND Administration	(15,680)	(15,680)	(260,890)	(15,680)	(15,680)	0	0.0%
Early Years & Child Care	90,489,770	9,076,180	9,045,660	93,248,540	9,091,640	15,460	0.2%
Home Management	1,669,070	470,850	286,850	1,684,830	486,610	15,760	3.3%
Total Children's Services and Neighbourhood Dev.	93,083,390	10,439,330	10,542,420	95,869,880	10,482,510	43,180	0.4%

BY COST CATEGORY

	2021	2021	2022	2022 Preliminary Budget vs. 2021 Restated		
	Restated Budget	Projected Actual	Preliminary Budget	Change \$	Change %	
EMPLOYEE RELATED COST		9,423,030	9,151,820	9,514,420	91,390	1.0%
MATERIAL & SUPPLY		737,310	439,510	742,470	5,160	0.7%
BUILDING & GROUND		45,100	219,330	45,950	850	1.9%
CONTRACTUAL		428,790	397,410	443,780	14,990	3.5%
AGENCIES & SUPPORT PAYMENTS		81,689,070	81,374,440	84,355,310	2,666,240	3.3%
RESERVES/RECOVERIES		335,620	(781,030)	338,410	2,790	0.8%
COST ALLOCATIONS		377,330	369,360	384,900	7,570	2.0%
FINANCIAL		47,140	41,490	44,640	(2,500)	(5.3)%
TOTAL EXPENSES		93,083,390	91,212,330	95,869,880	2,786,490	3.0%
FEES & GENERAL		(3,316,520)	(2,472,170)	(3,316,520)	0	0.0%
GRANTS & SUBSIDIES		(79,117,540)	(78,197,740)	(81,598,150)	(2,480,610)	(3.1)%
RESERVES		(210,000)	0	(472,700)	(262,700)	(125.1)%
TOTAL REVENUES		(82,644,060)	(80,669,910)	(85,387,370)	(2,743,310)	(3.3)%
NET LEVY		10,439,330	10,542,420	10,482,510	43,180	0.4%

DIVISION STRUCTURE

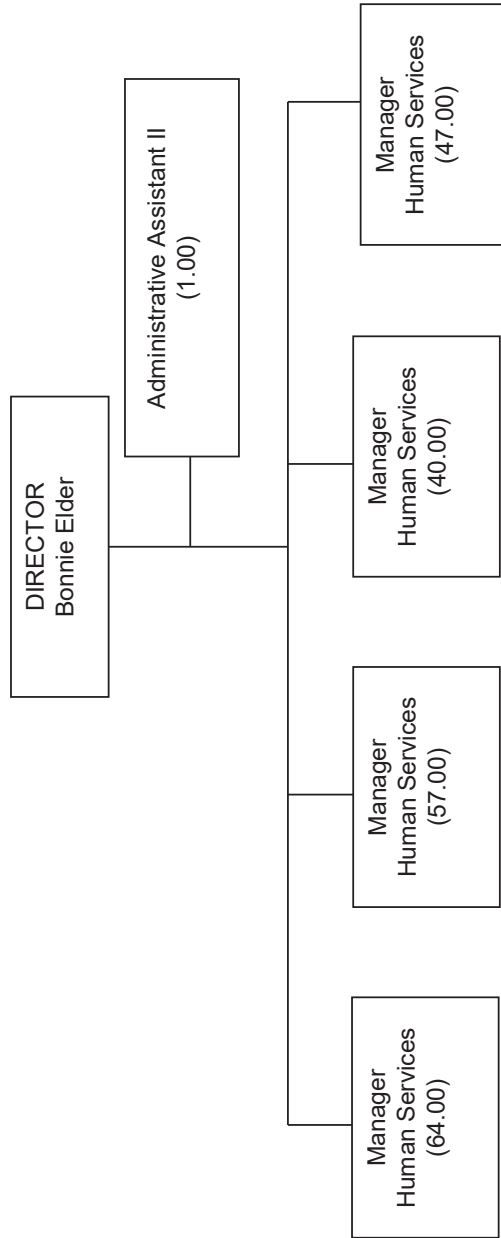

COMPLEMENT (FTE)	MANAGEMENT	OTHER	TOTAL	STAFF/MGT RATIO
2021	5.00	205.00	210.00	41:1
2022	5.00	205.00	210.00	41:1
CHANGE	0.00	0.00	0.00	

2022 Preliminary Tax Supported Operating Budget

BY SECTION

	2021 Restated Gross	2021 Restated Net	2021 Projected Actual Net	2022 Preliminary Budget Gross	2022 Preliminary Budget Net	2022 Preliminary Budget vs. 2021 Restated	
						Change \$	Change %
Client Benefits/Spec Supports	119,928,100	1,091,660	575,870	119,815,840	1,222,200	130,540	12.0%
OW Admin	25,449,370	11,230,270	9,751,550	25,858,680	11,619,940	389,670	3.5%
Total Ontario Works	145,377,470	12,321,930	10,327,420	145,674,520	12,842,140	520,210	4.2%

BY COST CATEGORY

	2021 Restated	2021 Budget	2021 Projected Actual	2022 Preliminary Budget	2022 Preliminary Budget vs. 2021 Restated		
					Change \$	Change %	
EMPLOYEE RELATED COST			20,409,620	19,882,450	20,848,420	438,800	2.2%
MATERIAL & SUPPLY			679,010	396,540	673,570	(5,440)	(0.8)%
BUILDING & GROUND			1,756,040	2,043,900	1,763,840	7,800	0.4%
CONTRACTUAL			203,120	233,150	273,870	70,750	34.8%
AGENCIES & SUPPORT PAYMENTS			120,718,120	101,268,760	120,595,140	(122,980)	(0.1)%
RESERVES/RECOVERIES			559,350	634,830	459,320	(100,030)	(17.9)%
COST ALLOCATIONS			751,390	739,180	767,540	16,150	2.1%
FINANCIAL			300,820	200,090	292,820	(8,000)	(2.7)%
TOTAL EXPENSES			145,377,470	125,398,900	145,674,520	297,050	0.2%
FEES & GENERAL			(1,888,470)	(1,885,010)	(1,923,040)	(34,570)	(1.8)%
GRANTS & SUBSIDIES			(131,078,520)	(113,065,470)	(130,801,720)	276,800	0.2%
RESERVES			(88,550)	(121,000)	(107,620)	(19,070)	(21.5)%
TOTAL REVENUES			(133,055,540)	(115,071,480)	(132,832,380)	223,160	0.2%
NET LEVY			12,321,930	10,327,420	12,842,140	520,210	4.2%

HOUSING SERVICES

DIVISION STRUCTURE

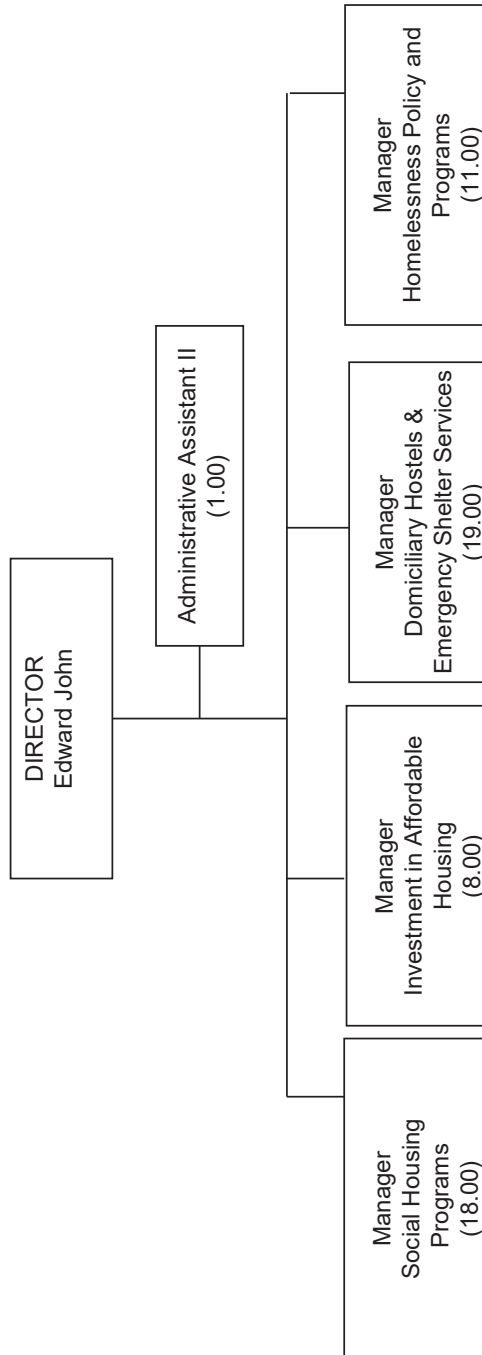

COMPLEMENT (FTE)	MANAGEMENT	OTHER	TOTAL	STAFF/MGT RATIO
2021	5.00	53.00	58.00	10.60:1
2022	5.00	53.00	58.00	10.60:1
CHANGE	0.00	0.00	0.00	

2022 Preliminary Tax Supported Operating Budget

BY SECTION

	2021	2021	2021	2022	2022	2022 Preliminary Budget vs. 2021 Restated	
	Restated Gross	Restated Net	Projected Actual Net	Preliminary Budget Gross	Preliminary Budget Net	Change \$	Change %
Housing Services Administration	6,310,250	603,070	682,030	23,218,230	689,230	86,160	14.3%
Affordable Housing	9,180,990	6,655,380	5,882,160	10,772,440	7,199,830	544,450	8.2%
Homelessness Policy & Program	33,271,880	5,807,390	3,366,000	34,976,387	7,349,567	1,542,177	26.6%
Social Housing	48,891,840	34,260,020	33,285,170	51,364,233	38,698,873	4,438,853	13.0%
Total Housing Services	97,654,960	47,325,860	43,215,360	120,331,290	53,937,500	6,611,640	14.0%

BY COST CATEGORY

	2021	2021	2022	2022 Preliminary Budget vs. 2021 Restated		
	Restated Budget	Projected Actual	Preliminary Budget	Change \$	Change %	
EMPLOYEE RELATED COST		6,552,700	5,860,900	6,971,010	418,310	6.4%
MATERIAL & SUPPLY		695,330	691,500	3,936,250	3,240,920	466.1%
BUILDING & GROUND		271,030	486,420	1,005,240	734,210	270.9%
CONSULTING		800	800	800	0	0.0%
CONTRACTUAL		477,190	293,930	528,940	51,750	10.8%
AGENCIES & SUPPORT PAYMENTS		89,916,400	89,489,380	104,681,230	14,764,830	16.4%
RESERVES/RECOVERIES		288,860	651,790	771,880	483,020	167.2%
COST ALLOCATIONS		(245,110)	(99,190)	(239,960)	5,150	2.1%
FINANCIAL		1,134,210	1,116,110	2,181,210	1,047,000	92.3%
CAPITAL FINANCING		0	0	1,250,790	1,250,790	100.0%
CAPITAL EXPENDITURES		0	10,200	0	0	0.0%
RECOVERIES FROM CAPITAL		(1,436,450)	(1,069,950)	(756,100)	680,350	47.4%
TOTAL EXPENSES		97,654,960	97,431,890	120,331,290	22,676,330	23.2%
FEES & GENERAL		(100,000)	(525,120)	(100,000)	0	0.0%
GRANTS & SUBSIDIES		(44,354,470)	(43,865,970)	(42,550,340)	1,804,130	4.1%
RESERVES		(5,874,630)	(9,825,440)	(23,743,450)	(17,868,820)	(304.2)%
TOTAL REVENUES		(50,329,100)	(54,216,530)	(66,393,790)	(16,064,690)	(31.9)%
NET LEVY		47,325,860	43,215,360	53,937,500	6,611,640	14.0%

LONG TERM CARE – Macassa Lodge

DIVISION STRUCTURE

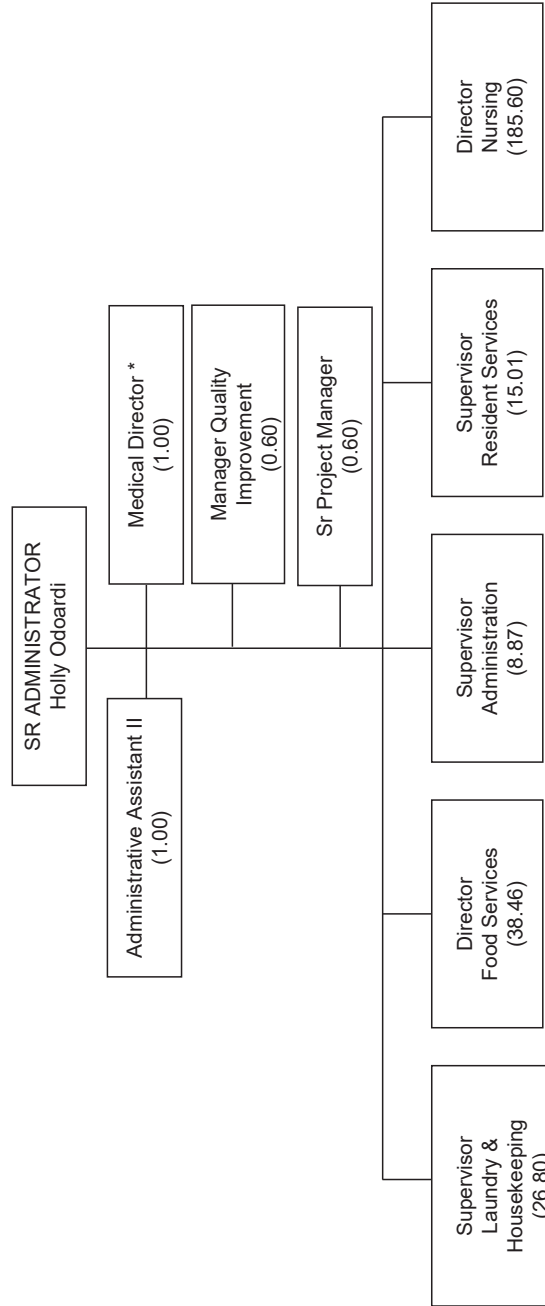

* Not included in complement

COMPLEMENT (FTE)	MANAGEMENT	OTHER	TOTAL	STAFF/MGT RATIO
2021	7.00	270.94	277.94	38.71:1
2022	7.00	270.94	277.94	38.71:1
CHANGE	0.00	0.00	0.00	

LONG TERM CARE
-WentworthLodge

DIVISION STRUCTURE

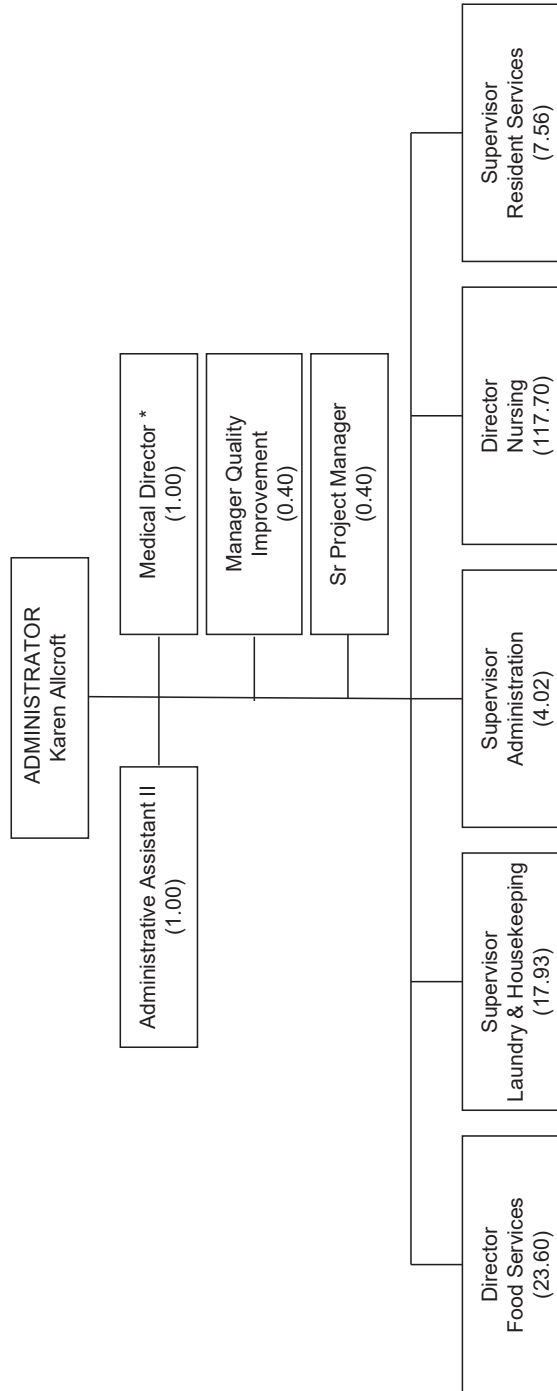

* Not included in complement

COMPLEMENT (FTE)	MANAGEMENT	OTHER	TOTAL	STAFF/MGT RATIO
2021	5.00	168.61	173.61	33.72:1
2022	5.00	168.61	173.61	33.72:1
CHANGE	0.00	0.00	0.00	

2022 Preliminary Tax Supported Operating Budget

BY SECTION

	2021	2021	2021	2022	2022	2022 Preliminary Budget vs. 2021 Restated	
	Restated Gross	Restated Net	Projected Actual Net	Preliminary Budget Gross	Preliminary Budget Net	Change \$	Change %
Macassa Lodge	27,605,380	6,498,060	5,129,990	28,970,690	6,919,430	421,370	6.5%
Wentworth Lodge	17,213,110	5,026,800	4,317,370	18,039,810	4,848,890	(177,910)	(3.5)%
Total Long Term Care	44,818,490	11,524,860	9,447,360	47,010,500	11,768,320	243,460	2.1%

BY COST CATEGORY

	2021	2021	2022	2022 Preliminary Budget vs. 2021 Restated			
	Restated	Budget	Projected Actual	Preliminary Budget	Change \$	Change %	
EMPLOYEE RELATED COST			40,488,610	43,187,980	41,532,210	1,043,600	2.6%
MATERIAL & SUPPLY			3,336,330	4,570,160	3,245,430	(90,900)	(2.7)%
VEHICLE EXPENSES			0	120	0	0	0.0%
BUILDING & GROUND			31,390	31,690	31,770	380	1.2%
CONTRACTUAL			565,130	719,270	608,170	43,040	7.6%
AGENCIES & SUPPORT PAYMENTS			111,900	127,140	121,900	10,000	8.9%
RESERVES/RECOVERIES			220,290	204,170	1,373,980	1,153,690	523.7%
COST ALLOCATIONS			2,950	2,950	2,950	0	0.0%
FINANCIAL			61,890	55,890	94,090	32,200	52.0%
TOTAL EXPENSES			44,818,490	48,899,370	47,010,500	2,192,010	4.9%
FEES & GENERAL			(11,556,970)	(10,560,260)	(11,473,070)	83,900	0.7%
GRANTS & SUBSIDIES			(21,328,430)	(28,040,100)	(23,219,320)	(1,890,890)	(8.9)%
RESERVES			(408,230)	(851,650)	(549,790)	(141,560)	(34.7)%
TOTAL REVENUES			(33,293,630)	(39,452,010)	(35,242,180)	(1,948,550)	(5.9)%
NET LEVY			11,524,860	9,447,360	11,768,320	243,460	2.1%

RECREATION

DIVISION STRUCTURE

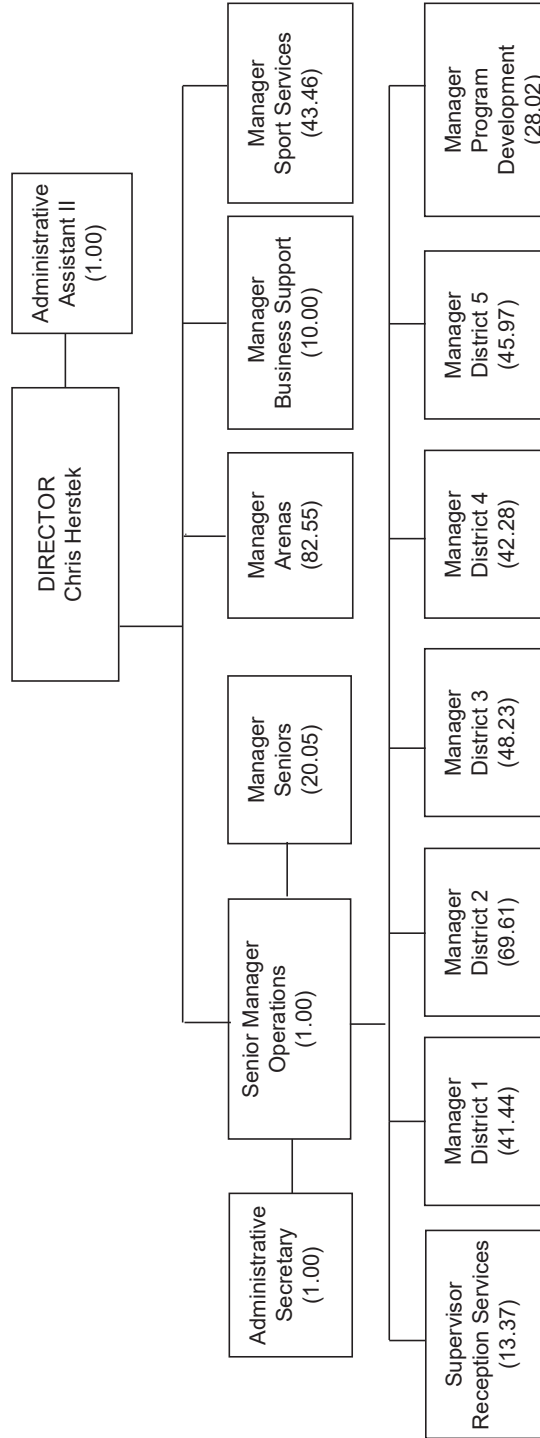

COMPLEMENT (FTE)	MANAGEMENT	OTHER	TOTAL	STAFF/MGT RATIO
2021	12.00	437.24	449.24	36.44:1
2022	12.00	436.98	448.98	36.42:1
CHANGE	0.00	(0.26)	(0.26)	

2022 Preliminary Tax Supported Operating Budget

BY SECTION

	2021	2021	2021	2022	2022	2022 Preliminary Budget vs. 2021 Restated	
	Restated Gross	Restated Net	Projected Actual Net	Preliminary Budget Gross	Preliminary Budget Net	Change \$	Change %
City Wide Services & Programs	9,053,950	4,014,370	5,630,430	9,402,490	4,392,680	378,310	9.4%
Recreation Administration	52,910	(63,090)	(1,060,170)	(42,360)	(56,690)	6,400	10.1%
Recreation District Operations	45,670,820	31,368,360	30,693,690	46,615,320	31,652,580	284,220	0.9%
Total Recreation	54,777,680	35,319,640	35,263,950	55,975,450	35,988,570	668,930	1.9%

BY COST CATEGORY

	2021	2021	2022	2022 Preliminary Budget vs. 2021 Restated	
	Restated Budget	Projected Actual	Preliminary Budget	Change \$	Change %
EMPLOYEE RELATED COST		32,017,140	30,918,020	32,561,920	544,780 1.7%
MATERIAL & SUPPLY		1,985,250	2,954,530	1,879,780	(105,470) (5.3)%
VEHICLE EXPENSES		643,680	583,270	630,030	(13,650) (2.1)%
BUILDING & GROUND		8,208,530	7,056,400	8,342,140	133,610 1.6%
CONTRACTUAL		2,551,890	3,027,440	2,670,330	118,440 4.6%
AGENCIES & SUPPORT PAYMENTS		977,160	955,440	986,660	9,500 1.0%
RESERVES/RECOVERIES		7,308,690	7,326,730	7,536,760	228,070 3.1%
COST ALLOCATIONS		28,700	37,130	274,430	245,730 856.2%
FINANCIAL		571,680	652,930	608,440	36,760 6.4%
CAPITAL FINANCING		484,960	484,960	484,960	0 0.0%
TOTAL EXPENSES		54,777,680	53,996,850	55,975,450	1,197,770 2.2%
FEES & GENERAL		(11,737,570)	(16,708,510)	(12,305,660)	(568,090) (4.8)%
GRANTS & SUBSIDIES		(427,000)	(855,730)	(427,000)	0 0.0%
RESERVES		(7,293,470)	(1,168,660)	(7,254,220)	39,250 0.5%
TOTAL REVENUES		(19,458,040)	(18,732,900)	(19,986,880)	(528,840) (2.7)%
NET LEVY		35,319,640	35,263,950	35,988,570	668,930 1.9%

DIVISION STRUCTURE

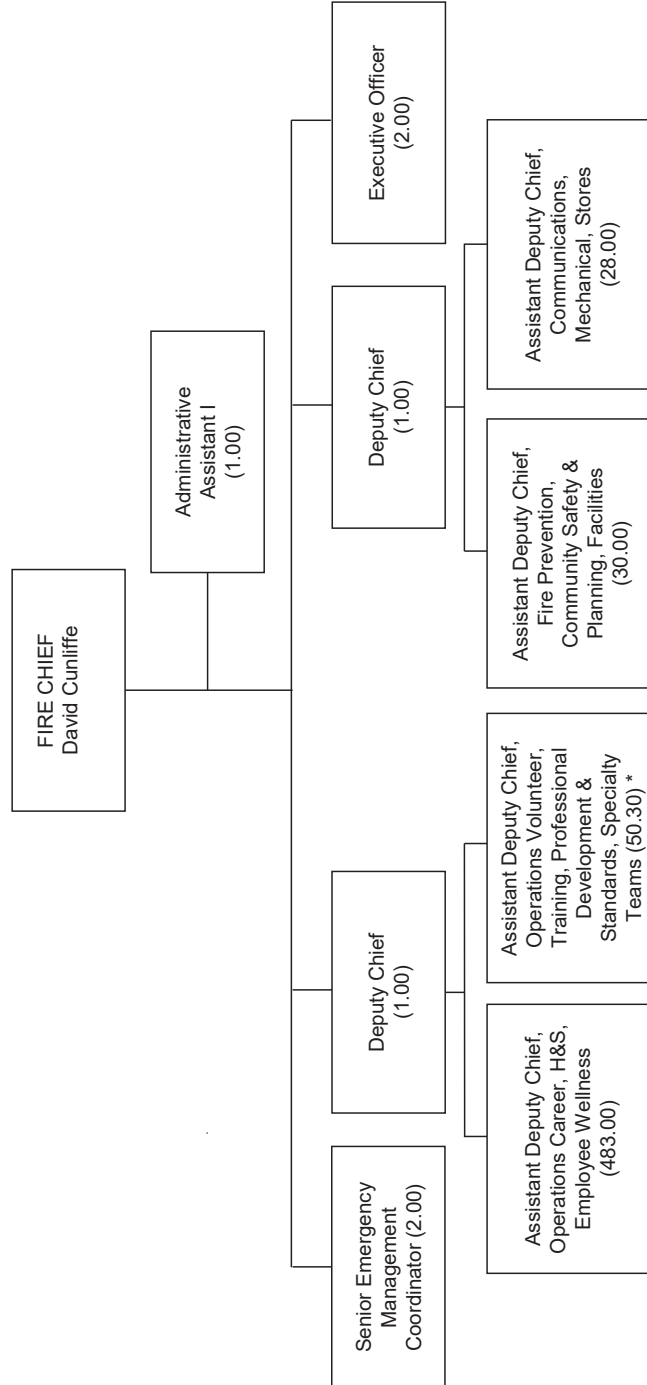

COMPLEMENT (FTE)	MANAGEMENT	OTHER	TOTAL	STAFF/AMGT RATIO
2021	9.00	586.30	595.30	65.14:1
2022	9.00	590.30	599.30	65.59:1
CHANGE	0.00	4.00	4.00	

* includes 40:30 FTE Volunteer Firefighters = 280 Head Count

2022 Preliminary Tax Supported Operating Budget

BY SECTION

	2021	2021	2021	2022	2022	2022 Preliminary Budget vs. 2021 Restated	
	Restated Gross	Restated Net	Projected Actual Net	Preliminary Budget Gross	Preliminary Budget Net	Change \$	Change %
Emergency Management	445,970	445,970	412,850	437,730	437,730	(8,240)	(1.8)%
Fire Administration	1,903,170	1,903,170	1,765,310	1,902,130	1,902,130	(1,040)	(0.1)%
Fire Operations	92,989,020	90,939,310	90,895,600	96,691,820	95,186,580	4,247,270	4.7%
Total Hamilton Fire Department	95,338,160	93,288,450	93,073,760	99,031,680	97,526,440	4,237,990	4.5%

BY COST CATEGORY

	2021	2021	2022	2022 Preliminary Budget vs. 2021 Restated	
	Restated Budget	Projected Actual	Preliminary Budget	Change \$	Change %
EMPLOYEE RELATED COST	84,667,960	84,990,920	87,165,860	2,497,900	3.0%
MATERIAL & SUPPLY	1,618,660	2,186,690	1,792,820	174,160	10.8%
VEHICLE EXPENSES	1,029,150	1,135,610	1,178,690	149,540	14.5%
BUILDING & GROUND	1,057,060	1,130,270	1,074,640	17,580	1.7%
CONSULTING	15,000	(5,090)	0	(15,000)	(100.0)%
CONTRACTUAL	201,680	294,290	286,660	84,980	42.1%
RESERVES/RECOVERIES	6,321,280	6,402,100	6,996,410	675,130	10.7%
COST ALLOCATIONS	78,270	80,150	184,550	106,280	135.8%
FINANCIAL	349,100	362,030	352,050	2,950	0.8%
TOTAL EXPENSES	95,338,160	96,576,970	99,031,680	3,693,520	3.9%
FEES & GENERAL	(594,710)	(512,130)	(1,043,400)	(448,690)	(75.4)%
GRANTS & SUBSIDIES	0	(137,000)	0	0	0.0%
RESERVES	(1,455,000)	(2,854,080)	(461,840)	993,160	68.3%
TOTAL REVENUES	(2,049,710)	(3,503,210)	(1,505,240)	544,470	26.6%
NET LEVY	93,288,450	93,073,760	97,526,440	4,237,990	4.5%

DIVISION STRUCTURE

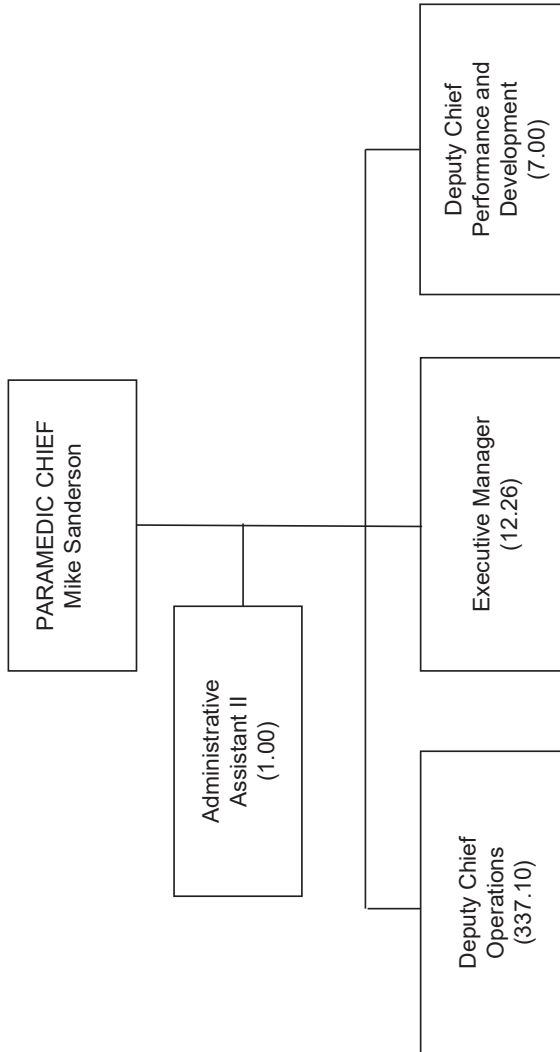

COMPLEMENT (FTE)	MANAGEMENT	OTHER	TOTAL	STAFF/MGT RATIO
2021	8.00	350.36	358.36	43.80:1
2022	8.00	350.36	358.36	43.80:1
CHANGE	0.00	0.00	0.00	

2022 Preliminary Tax Supported Operating Budget

BY SECTION

	2021 Restated Gross	2021 Restated Net	2021 Projected Actual Net	2022 Preliminary Budget Gross	2022 Preliminary Budget Net	2022 Preliminary Budget vs. 2021 Restated	
						Change \$	Change %
Paramedic Service Admin	2,959,220	2,959,220	3,102,980	2,991,370	2,991,370	32,150	1.1%
Paramedic Service Operations	58,538,660	51,211,830	53,283,520	61,193,370	53,624,210	2,412,380	4.7%
Paramedic Service Provincial Funding	0	(26,068,560)	(26,068,560)	0	(28,220,190)	(2,151,630)	(8.3)%
Total Hamilton Paramedic Service	61,497,880	28,102,490	30,317,940	64,184,740	28,395,390	292,900	1.0%

BY COST CATEGORY

	2021 Restated	2021 Budget	2021 Projected Actual	2022 Preliminary Budget	2022 Preliminary Budget vs. 2021 Restated	
					Change \$	Change %
EMPLOYEE RELATED COST		50,290,900	51,451,610	52,460,670	2,169,770	4.3%
MATERIAL & SUPPLY		2,891,020	3,060,250	2,602,110	(288,910)	(10.0)%
VEHICLE EXPENSES		1,026,710	1,037,580	1,199,800	173,090	16.9%
BUILDING & GROUND		349,020	389,650	367,190	18,170	5.2%
CONTRACTUAL		1,672,990	1,730,160	1,693,530	20,540	1.2%
RESERVES/RECOVERIES		3,603,510	3,633,160	4,179,490	575,980	16.0%
COST ALLOCATIONS		1,578,490	1,578,910	1,596,710	18,220	1.2%
FINANCIAL		85,240	88,380	85,240	0	0.0%
CAPITAL EXPENDITURES		0	108,050	0	0	0.0%
TOTAL EXPENSES		61,497,880	63,077,750	64,184,740	2,686,860	4.4%
FEES & GENERAL		(84,790)	(152,820)	(87,420)	(2,630)	(3.1)%
GRANTS & SUBSIDIES		(30,995,780)	(32,606,990)	(33,207,110)	(2,211,330)	(7.1)%
RESERVES		(2,314,820)	0	(2,494,820)	(180,000)	(7.8)%
TOTAL REVENUES		(33,395,390)	(32,759,810)	(35,789,350)	(2,393,960)	(7.2)%
NET LEVY		28,102,490	30,317,940	28,395,390	292,900	1.0%

DIVISION STRUCTURE

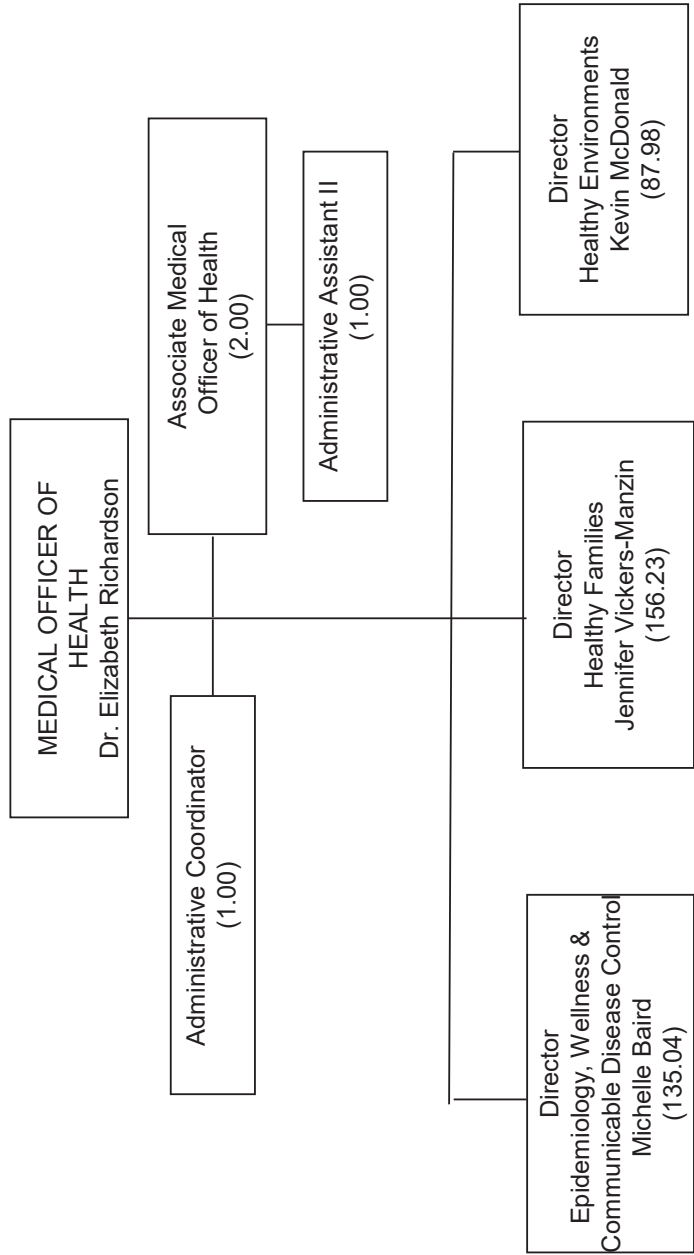

COMPLEMENT (FTE)	MANAGEMENT	OTHER	TOTAL	STAFF/AMGT RATIO
2021	23.00	363.25	386.25 ^{1,2}	15.79:1
2022	23.00	361.25	384.25 ^{1,2}	15.71:1
CHANGE	0.00	(2.00)	(2.00)	

¹ Excludes 6.50 (2021 – 6.50) Finance & Administration FTE – Included in Overall Departmental Org Chart.

² Excludes 484.70 Temporary COVID19 Response Related FTE funded through senior levels of government.

2022 Preliminary Tax Supported Operating Budget

BY SECTION

	2021 Restated Gross	2021 Restated Net	2021 Projected Actual Net	2022 Preliminary Budget Gross	2022 Preliminary Budget Net	2022 Preliminary Budget vs. 2021 Restated	
						Change \$	Change %
Medical Officer of Health & Provincial Subsidy	3,374,750	(26,561,330)	(26,391,780)	3,932,550	(26,518,150)	43,180	0.2%
Epidemiology Wellness and Communicable Disease Control	30,781,720	15,297,280	26,600,530	61,790,060	15,618,770	321,490	2.1%
Healthy Environments	12,606,950	11,802,750	5,671,990	12,629,180	11,977,540	174,790	1.5%
Healthy Families	22,010,580	12,965,220	7,218,890	23,254,380	13,261,140	295,920	2.3%
Total Public Health Services	68,774,000	13,503,920	13,099,630	101,606,170	14,339,300	835,380	6.2%

BY COST CATEGORY

	2021 Restated Budget	2021 Projected Actual	2022 Preliminary Budget	2022 Preliminary Budget vs. 2021 Restated	
				Change \$	Change %
EMPLOYEE RELATED COST		57,028,110	67,520,210	85,677,980	28,649,870 50.2%
MATERIAL & SUPPLY		2,095,270	2,848,990	3,477,410	1,382,140 66.0%
VEHICLE EXPENSES		56,380	83,850	109,370	52,990 94.0%
BUILDING & GROUND		2,144,830	3,560,220	3,705,600	1,560,770 72.8%
CONSULTING		39,990	69,090	614,990	575,000 1437.9%
CONTRACTUAL		2,625,880	2,612,030	2,263,950	(361,930) (13.8)%
AGENCIES & SUPPORT PAYMENTS		68,190	460,560	413,190	345,000 505.9%
RESERVES/RECOVERIES		519,930	769,270	989,920	469,990 90.4%
COST ALLOCATIONS		3,292,820	3,316,740	3,370,540	77,720 2.4%
FINANCIAL		368,820	446,160	449,440	80,620 21.9%
CAPITAL FINANCING		533,780	533,790	533,780	0 0.0%
TOTAL EXPENSES		68,774,000	82,220,910	101,606,170	32,832,170 47.7%
FEES & GENERAL		(1,549,750)	(1,440,280)	(1,432,330)	117,420 7.6%
GRANTS & SUBSIDIES		(41,079,890)	(67,481,000)	(41,010,590)	69,300 0.2%
RESERVES		(12,640,440)	(200,000)	(44,823,950)	(32,183,510) (254.6)%
TOTAL REVENUES		(55,270,080)	(69,121,280)	(87,266,870)	(31,996,790) (57.9)%
NET LEVY		13,503,920	13,099,630	14,339,300	835,380 6.2%

PUBLIC WORKS



DEPARTMENT STRUCTURE

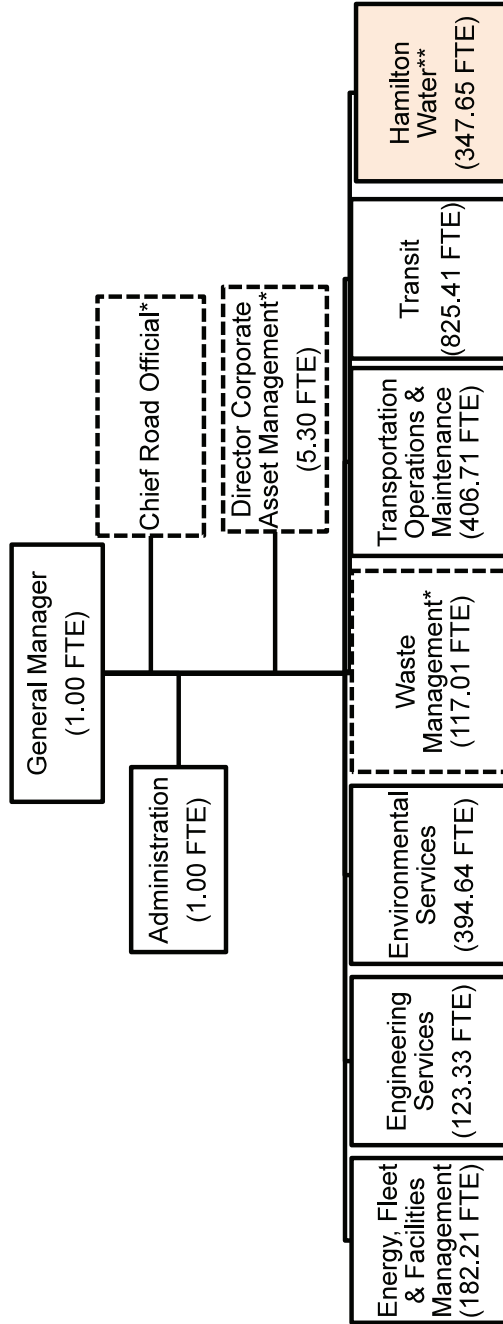

COMPLEMENT (FTE)	MANAGEMENT	OTHER	TOTAL	STAFF/MGT RATIO
2021	33.00	1980.35	2013.35	60.01:1
2022	33.00	2023.61	2056.61	61.32:1
CHANGE	0.00	43.26	43.26	

* 3.0 Director positions are excluded from the 2022 Budgeted Complement count. The positions are currently temporary and not counted as part of the permanent FTE Complement. If positions were included the Staff to Mgt Ratio would be 56.21 :1

** Complement excludes Hamilton Water

2022 Preliminary Tax Supported Operating Budget

BY DIVISION

	2021	2021	2021	2022	2022	2022 Preliminary Budget vs. 2021 Restated	
	Restated Gross	Restated Net	Projected Actual Net	Preliminary Budget Gross	Preliminary Budget Net	Change \$	Change %
PW-General Administration	634,870	634,870	634,870	658,900	658,900	24,030	3.8%
Energy Fleet and Facilities	20,591,760	13,273,690	13,761,440	21,946,740	14,276,080	1,002,390	7.6%
Engineering Services	4,384,880	0	(450,000)	4,641,230	0	0	0.0%
Environmental Services	47,125,440	44,240,900	43,028,770	48,556,680	45,582,310	1,341,410	3.0%
Transit	141,598,570	80,834,700	79,958,980	150,197,660	87,972,010	7,137,310	8.8%
Transportation Operations & Maintenance	90,581,310	83,485,680	77,739,010	91,441,190	84,234,120	748,440	0.9%
Waste Management	58,942,610	44,104,610	42,071,880	62,013,470	46,944,820	2,840,210	6.4%
Total Public Works	363,859,440	266,574,450	256,744,950	379,455,870	279,668,240	13,093,790	4.9%

BY COST CATEGORY

	2021	2021	2022	2022 Preliminary Budget vs. 2021 Restated	
	Restated Budget	Projected Actual	Preliminary Budget	Change \$	Change %
EMPLOYEE RELATED COST	194,315,490	189,187,740	201,488,940	7,173,450	3.7%
MATERIAL & SUPPLY	25,511,100	24,275,960	24,061,790	(1,449,310)	(5.7)%
VEHICLE EXPENSES	32,693,830	33,146,720	35,025,680	2,331,850	7.1%
BUILDING & GROUND	21,092,200	21,280,520	21,441,450	349,250	1.7%
CONSULTING	179,470	179,470	179,470	0	0.0%
CONTRACTUAL	97,997,830	85,038,930	102,517,710	4,519,880	4.6%
AGENCIES & SUPPORT PAYMENTS	29,480	29,480	29,480	0	0.0%
RESERVES/RECOVERIES	8,510,040	8,610,600	10,483,340	1,973,300	23.2%
COST ALLOCATIONS	3,070,490	3,160,410	2,491,610	(578,880)	(18.9)%
FINANCIAL	5,869,040	3,440,890	6,460,320	591,280	10.1%
CAPITAL FINANCING	1,650,000	1,650,000	1,650,000	0	0.0%
RECOVERIES FROM CAPITAL	(27,059,530)	(27,014,440)	(26,373,930)	685,600	(2.5)%
TOTAL EXPENSES	363,859,440	342,986,280	379,455,860	15,596,420	4.3%
FEES & GENERAL	(76,144,580)	(57,401,350)	(80,466,960)	(4,322,380)	5.7%
GRANTS & SUBSIDIES	(17,458,380)	(26,147,950)	(17,256,380)	202,000	(1.2)%
RESERVES	(3,682,030)	(2,692,030)	(2,064,280)	1,617,750	(43.9)%
TOTAL REVENUES	(97,284,990)	(86,241,330)	(99,787,620)	(2,502,630)	2.6%
NET LEVY	266,574,450	256,744,950	279,668,240	13,093,790	4.9%

2022 Preliminary Tax Supported Operating Budget Multi-Year Budget Outlook

BY DIVISION

	2022 Preliminary Budget Gross	2022 Preliminary Budget Net	2023 Preliminary Gross	2023 Preliminary Net	2024 Preliminary Gross	2024 Preliminary Net	2025 Preliminary Gross	2025 Preliminary Net
PW-General Administration	658,900	658,900	678,380	678,380	696,120	696,120	711,660	711,660
Energy Fleet and Facilities	21,946,740	14,276,080	22,138,580	14,485,690	22,371,500	14,634,330	22,537,780	14,727,860
Engineering Services	4,641,230	0	4,482,450	0	4,519,170	0	4,552,470	0
Environmental Services	48,556,680	45,582,310	49,468,000	46,473,640	50,346,300	47,295,320	51,124,380	48,073,400
Transit	150,197,660	87,972,010	158,421,510	93,682,440	168,535,710	100,912,540	179,015,740	108,809,480
Transportation Operations & Maintenance	91,441,190	84,234,120	96,171,250	88,836,070	97,570,930	90,112,380	98,810,390	91,351,840
Waste Management	62,013,470	46,944,820	63,638,560	48,500,590	65,493,200	50,268,210	67,227,380	52,002,390
Total Public Works	379,455,870	279,668,240	394,998,730	292,656,810	409,532,930	303,918,900	423,979,800	315,676,630

2022 Preliminary Tax Supported Operating Budget

BY SECTION - GENERAL ADMINISTRATION

	2021 Restated Gross	2021 Restated Net	2021 Projected Actual Net	2022 Preliminary Budget Gross	2022 Preliminary Budget Net	2022 Preliminary Budget vs. 2021 Restated	
						Change \$	Change %
PW General Managers Office	634,870	634,870	634,870	658,900	658,900	24,030	3.8%
Total PW-General Administration	634,870	634,870	634,870	658,900	658,900	24,030	3.8%

BY COST CATEGORY - GENERAL ADMINISTRATION

	2021 Restated	2021 Budget	2021 Projected Actual	2022 Preliminary Budget	2022 Preliminary Budget vs. 2021 Restated	
					Change \$	Change %
EMPLOYEE RELATED COST		1,023,090	1,023,090	1,048,510	25,420	2.5%
MATERIAL & SUPPLY		43,130	43,130	43,130	0	0.0%
BUILDING & GROUND		159,340	159,340	159,470	130	0.1%
CONSULTING		30,000	30,000	30,000	0	0.0%
CONTRACTUAL		73,190	73,190	76,410	3,220	4.4%
RESERVES/RECOVERIES		84,820	84,820	123,470	38,650	45.6%
COST ALLOCATIONS		(778,700)	(778,700)	(822,090)	(43,390)	5.6%
TOTAL EXPENSES		634,870	634,870	658,900	24,030	3.8%
TOTAL REVENUES		0	0	0	0	0.0%
NET LEVY		634,870	634,870	658,900	24,030	3.8%

DIVISION STRUCTURE

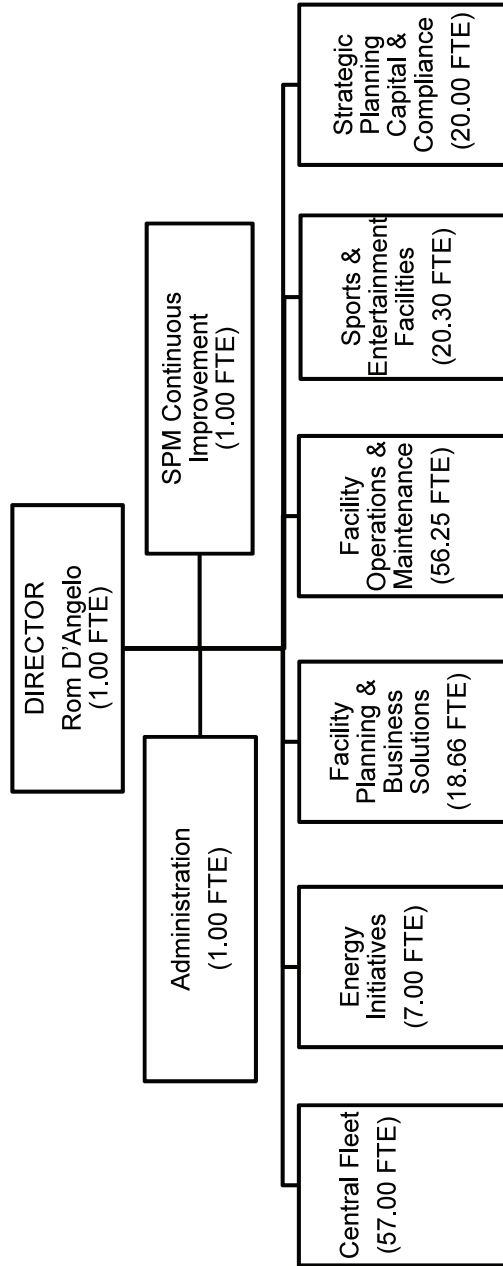

COMPLEMENT (FTE)	MANAGEMENT	OTHER	TOTAL	STAFF/MGT RATIO
2021	7.00	174.95	181.95	24.99:1
2022	7.00	175.21	182.21	25.03:1
CHANGE	0.00	0.26	0.26	

2022 Preliminary Tax Supported Operating Budget

BY SECTION

	2021	2021	2021	2022	2022	2022 Preliminary Budget vs. 2021	
	Restated Gross	Restated Net	Projected Actual Net	Preliminary Budget Gross	Preliminary Budget Net	Restated	
						Change \$	Change %
Fleet Services	1,488,390	62,630	317,630	1,652,400	147,780	85,150	136.0%
Corporate Facility Ops & Tech	3,091,580	2,000,660	2,090,150	2,964,940	1,813,140	(187,520)	(9.4)%
Facilities Planning and Business Solutions	1,543,950	948,010	942,270	1,807,310	1,218,840	270,830	28.6%
Community Facility Ops & Tech Serv	6,609,990	6,609,990	6,609,990	6,572,820	6,551,310	(58,680)	(0.9)%
Sports & Entertainment Facilities	6,329,710	3,097,410	3,459,910	6,778,240	3,696,350	598,940	19.3%
Director EFF	335,390	312,560	99,050	488,750	465,550	152,990	48.9%
Energy Initiatives	950,320	0	0	1,366,530	0	0	100.0%
Strategic Plan & Capital Compliance	242,430	242,430	242,440	315,750	383,110	140,680	58.0%
Total Energy Fleet and Facilities	20,591,760	13,273,690	13,761,440	21,946,740	14,276,080	1,002,390	7.6%

BY COST CATEGORY

	2021	2021	2022	2022 Preliminary Budget vs. 2021	
	Restated Budget	Projected Actual	Preliminary Budget	Restated	
				Change \$	Change %
EMPLOYEE RELATED COST	20,281,350	20,371,030	20,834,780	553,430	2.7%
MATERIAL & SUPPLY	1,637,660	1,821,410	1,649,790	12,130	0.7%
VEHICLE EXPENSES	6,653,430	6,653,430	6,885,820	232,390	3.5%
BUILDING & GROUND	13,783,450	13,971,770	14,096,270	312,820	2.3%
CONSULTING	30,000	30,000	30,000	0	0.0%
CONTRACTUAL	8,200,350	8,455,860	8,684,750	484,400	5.9%
RESERVES/RECOVERIES	(27,893,030)	(27,659,630)	(27,924,450)	(31,420)	0.1%
COST ALLOCATIONS	(289,350)	(289,350)	(876,600)	(587,250)	203.0%
FINANCIAL	578,250	578,250	572,000	(6,250)	(1.1)%
CAPITAL FINANCING	750,000	750,000	750,000	0	0.0%
RECOVERIES FROM CAPITAL	(3,140,350)	(3,095,260)	(2,755,630)	384,720	(12.3)%
TOTAL EXPENSES	20,591,760	21,587,510	21,946,730	1,354,970	6.6%
FEES & GENERAL	(6,206,790)	(5,739,290)	(6,493,770)	(286,980)	4.6%
GRANTS & SUBSIDIES	0	(975,500)	0	0	0.0%
RESERVES	(1,111,280)	(1,111,280)	(1,176,880)	(65,600)	5.9%
TOTAL REVENUES	(7,318,070)	(7,826,070)	(7,670,650)	(352,580)	4.8%
NET LEVY	13,273,690	13,761,440	14,276,080	1,002,390	7.6%

DIVISION STRUCTURE

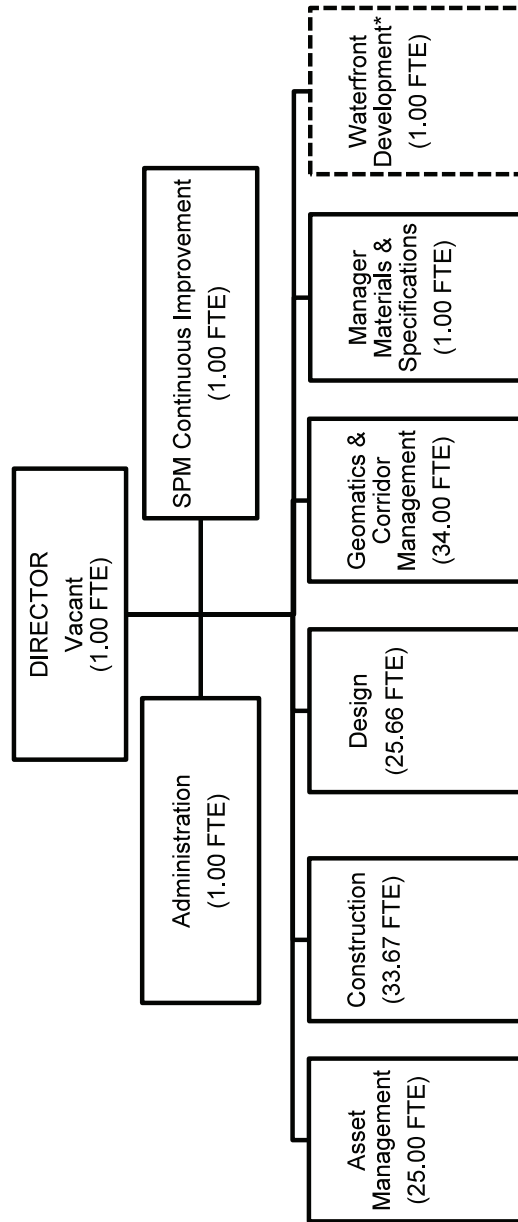

COMPLEMENT (FTE)	MANAGEMENT	OTHER	TOTAL	STAFF/MGT RATIO
2021	6.00	117.33	123.33	19.56:1
2022	6.00	117.33	123.33	19.56:1
CHANGE	0.00	0.00	0.00	

2022 Preliminary Tax Supported Operating Budget

BY SECTION

	2021		2021	2022		2022 Preliminary Budget vs. 2021 Restated	
	Restated	Gross	Projected Actual Net	Preliminary Budget Gross	Preliminary Budget Net	Change \$	Change %
Asset Management	0	0	0	0	0	0	0.0%
Construction	0	0	0	0	0	0	0.0%
Design Services	0	0	0	0	0	0	0.0%
Director of Engineering Services	0	0	0	0	0	0	0.0%
Geomatics and Corridor Management	4,384,880	0	(450,000)	4,641,230	0	0	0.0%
Waterfront Development	0	0	0	0	0	0	0.0%
Total Engineering Services	4,384,880	0	(450,000)	4,641,230	0	0	0.0%

BY COST CATEGORY

	2021		2021	2022	2022 Preliminary Budget vs. 2021 Restated		
	Restated	Budget	Projected Actual	Preliminary Budget	Change \$	Change %	
EMPLOYEE RELATED COST			14,640,710	14,640,710	15,135,140	494,430	3.4%
MATERIAL & SUPPLY			178,620	178,620	178,620	0	0.0%
VEHICLE EXPENSES			97,070	97,070	102,020	4,950	5.1%
BUILDING & GROUND			729,000	729,000	728,610	(390)	(0.1)%
CONTRACTUAL			2,287,560	2,287,560	2,287,560	0	0.0%
RESERVES/RECOVERIES			606,430	606,430	636,050	29,620	4.9%
COST ALLOCATIONS			1,620,810	1,620,810	1,685,050	64,240	4.0%
FINANCIAL			90,900	90,900	90,900	0	0.0%
CAPITAL FINANCING			900,000	900,000	900,000	0	0.0%
RECOVERIES FROM CAPITAL			(16,766,220)	(16,766,220)	(17,102,720)	(336,500)	2.0%
TOTAL EXPENSES			4,384,880	4,384,880	4,641,230	256,350	5.8%
FEES & GENERAL			(4,384,880)	(4,834,880)	(4,641,230)	(256,350)	5.8%
TOTAL REVENUES			(4,384,880)	(4,834,880)	(4,641,230)	(256,350)	5.8%
NET LEVY			0	(450,000)	0	0	0.0%

ENVIRONMENTAL SERVICES

DIVISION STRUCTURE

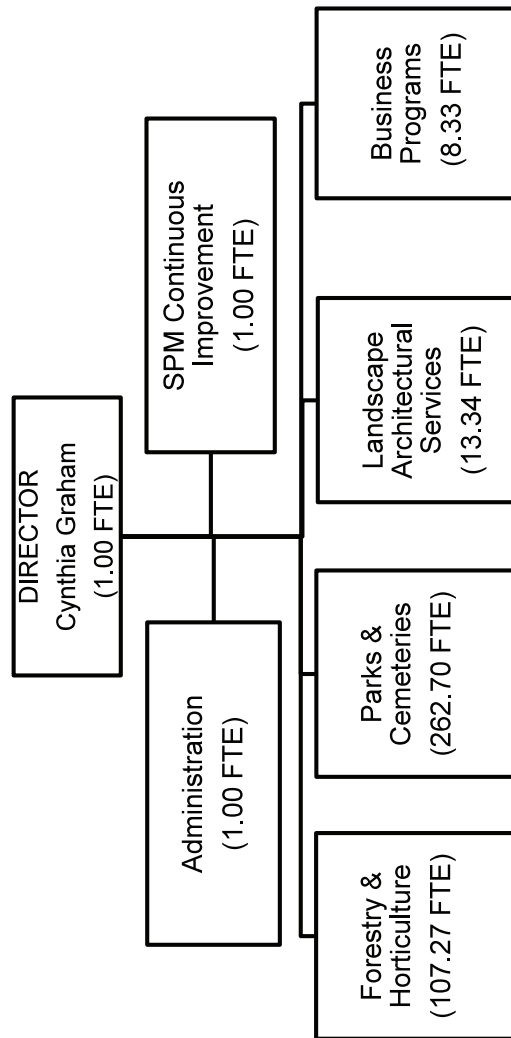

COMPLEMENT (FTE)	MANAGEMENT	OTHER	TOTAL	STAFF/MGT RATIO
2021	5.00	389.64	394.64	77.93:1
2022	5.00	389.64	394.64	77.93:1
CHANGE	0.00	0.00	0.00	

2022 Preliminary Tax Supported Operating Budget

BY SECTION

	2021	2021	2021	2022	2022	2022 Preliminary Budget vs. 2021 Restated	
	Restated Gross	Restated Net	Projected Actual Net	Preliminary Budget Gross	Preliminary Budget Net	Change \$	Change %
Business Programs	994,170	994,170	832,310	1,187,170	1,187,170	193,000	19.4%
Director Environ Services	(551,070)	(551,070)	(866,070)	(551,070)	(551,070)	0	0.0%
Forestry & Horticulture	14,621,560	14,175,850	14,082,000	14,852,830	14,399,710	223,860	1.6%
Landscape & Architectural Serv	119,590	119,590	104,050	274,350	274,350	154,760	129.4%
Parks & Cemeteries	31,941,190	29,502,360	28,876,480	32,793,400	30,272,150	769,790	2.6%
Total Environmental Services	47,125,440	44,240,900	43,028,770	48,556,680	45,582,310	1,341,410	3.0%

BY COST CATEGORY

	2021	2021	2022	2022 Preliminary Budget vs. 2021 Restated	
	Restated	Budget	Projected Actual	Preliminary Budget	Change \$
EMPLOYEE RELATED COST	31,497,980	30,239,460	32,483,150	985,170	3.1%
MATERIAL & SUPPLY	2,637,350	2,887,840	2,593,290	(44,060)	(1.7)%
VEHICLE EXPENSES	3,220,780	3,218,430	3,402,880	182,100	5.7%
BUILDING & GROUND	3,359,740	3,485,170	3,386,060	26,320	0.8%
CONSULTING	17,000	17,000	17,000	0	0.0%
CONTRACTUAL	4,753,370	4,754,860	4,756,560	3,190	0.1%
AGENCIES & SUPPORT PAYMENTS	12,000	12,000	12,000	0	0.0%
RESERVES/RECOVERIES	4,342,540	4,335,400	4,295,110	(47,430)	(1.1)%
COST ALLOCATIONS	332,760	(63,770)	330,200	(2,560)	(0.8)%
FINANCIAL	86,810	86,810	86,810	0	0.0%
RECOVERIES FROM CAPITAL	(3,134,890)	(3,134,890)	(2,806,380)	328,510	(10.5)%
TOTAL EXPENSES	47,125,440	45,838,310	48,556,680	1,431,240	3.0%
FEES & GENERAL	(2,884,540)	(2,809,540)	(2,938,890)	(54,350)	1.9%
RESERVES	0	0	(35,480)	(35,480)	0.0%
TOTAL REVENUES	(2,884,540)	(2,809,540)	(2,974,370)	(89,830)	3.1%
NET LEVY	44,240,900	43,028,770	45,582,310	1,341,410	3.0%

DIVISION STRUCTURE

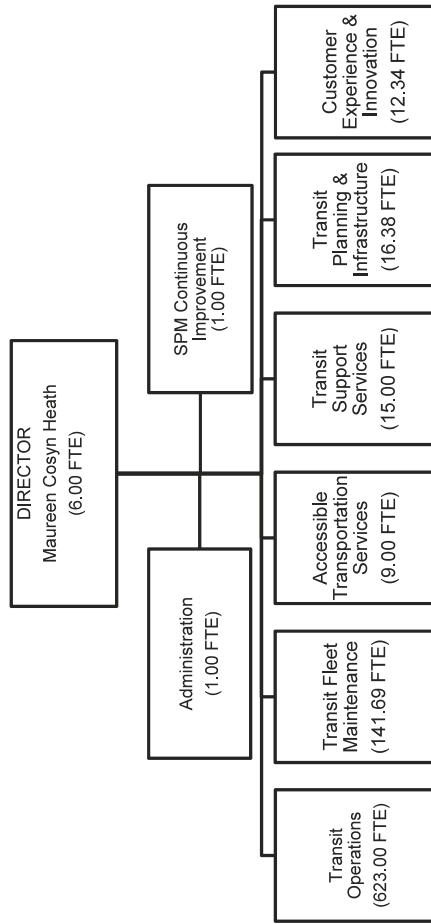

TRANSIT

COMPLEMENT (FTE)	MANAGEMENT	OTHER	TOTAL	STAFF/MGT RATIO
2021	7.00	775.41	782.41	110.77:1
2022	7.00	818.41	825.41	116.92:1
CHANGE	0.00	43.00	43.00	

2022 Preliminary Tax Supported Operating Budget

BY SECTION

	2021	2021	2021	2022	2022	2022 Preliminary Budget vs. 2021 Restated	
	Restated Gross	Restated Net	Projected Actual Net	Preliminary Budget Gross	Preliminary Budget Net	Change \$	Change %
Customer Experience and Innovation	1,639,560	1,639,560	1,639,560	1,841,070	1,841,070	201,510	12.3%
Transit Planning and Infrastructure	3,110,870	3,110,870	2,978,840	3,161,870	3,161,870	51,000	1.6%
Support Services	1,802,990	1,801,990	1,801,990	1,785,830	1,784,810	(17,180)	(1.0)%
Director Of Transit	140,730	140,730	(7,289,270)	627,860	627,860	487,130	346.1%
Financial Charges & General Revenue	17,669,230	(33,457,140)	(13,634,890)	17,999,300	(34,474,040)	(1,016,900)	3.0%
Operations HSR	58,255,830	51,355,470	51,355,450	62,760,350	55,859,980	4,504,510	8.8%
Transit Fleet	32,148,140	31,938,300	31,435,580	35,112,400	34,787,780	2,849,480	8.9%
ATS	26,831,220	24,304,920	11,671,720	26,908,980	24,382,680	77,760	0.3%
Total Transit	141,598,570	80,834,700	79,958,980	150,197,660	87,972,010	7,137,310	8.8%

BY COST CATEGORY

	2021	2021	2022	2022 Preliminary Budget vs. 2021 Restated	
	Restated Budget	Projected Actual	Preliminary Budget	Change \$	Change %
EMPLOYEE RELATED COST	76,561,230	76,127,740	81,102,610	4,541,380	5.9%
MATERIAL & SUPPLY	2,161,680	1,980,030	2,205,350	43,670	2.0%
VEHICLE EXPENSES	12,912,000	12,999,740	14,308,970	1,396,970	10.8%
BUILDING & GROUND	1,000,510	1,000,510	999,270	(1,240)	(0.1)%
CONSULTING	51,880	51,880	51,880	0	0.0%
CONTRACTUAL	27,512,340	14,952,250	27,812,840	300,500	1.1%
RESERVES/RECOVERIES	16,841,220	16,709,190	18,464,320	1,623,100	9.6%
COST ALLOCATIONS	496,010	520,670	603,690	107,680	21.7%
FINANCIAL	4,061,700	1,617,220	4,648,730	587,030	14.5%
TOTAL EXPENSES	141,598,570	125,959,230	150,197,660	8,599,090	6.1%
FEES & GENERAL	(48,874,870)	(27,598,140)	(51,211,940)	(2,337,070)	4.8%
GRANTS & SUBSIDIES	(10,899,000)	(18,402,110)	(10,899,000)	0	0.0%
RESERVES	(990,000)	0	(114,710)	875,290	(88.4)%
TOTAL REVENUES	(60,763,870)	(46,000,250)	(62,225,650)	(1,461,780)	2.4%
NET LEVY	80,834,700	79,958,980	87,972,010	7,137,310	8.8%

DIVISION STRUCTURE

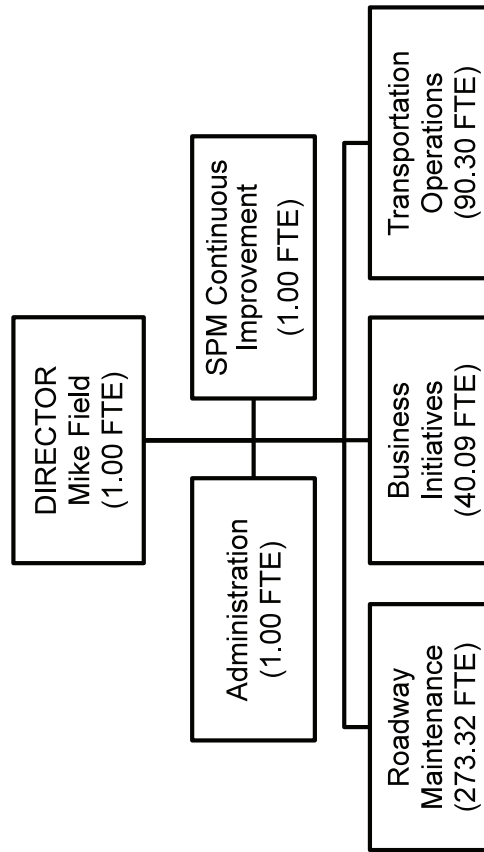

COMPLEMENT (FTE)	MANAGEMENT	OTHER	TOTAL	STAFF/MGT RATIO
2021	4.00	402.71	406.71	100.68:1
2022	4.00	402.71	406.71	100.68:1
CHANGE	0.00	0.00	0.00	

2022 Preliminary Tax Supported Operating Budget

BY SECTION

	2021	2021	2021	2022	2022	2022 Preliminary Budget vs. 2021 Restated	
	Restated Gross	Restated Net	Projected Actual Net	Preliminary Budget Gross	Preliminary Budget Net	Change \$	Change %
Roadway Maintenance	65,568,220	63,784,480	59,349,670	65,856,280	63,876,850	92,370	0.1%
Director – Trans Ops & Mtce	(629,950)	(629,950)	(629,950)	(622,000)	(622,000)	7,950	(1.3)%
Transportation Operations	21,095,690	15,843,200	14,885,070	21,534,130	16,367,080	523,880	3.3%
Business Initiatives	4,547,350	4,487,950	4,134,220	4,672,780	4,612,190	124,240	2.8%
Total Transportation Operations & Maintenance	90,581,310	83,485,680	77,739,010	91,441,190	84,234,120	748,440	0.9%

BY COST CATEGORY

	2021	2021	2022	2022 Preliminary Budget vs. 2021 Restated	
	Restated Budget	Projected Actual	Preliminary Budget	Change \$	Change %
EMPLOYEE RELATED COST	38,739,510	35,100,560	39,181,680	442,170	1.1%
MATERIAL & SUPPLY	18,371,750	16,879,510	16,915,500	(1,456,250)	(7.9)%
VEHICLE EXPENSES	7,602,540	7,817,680	8,005,820	403,280	5.3%
BUILDING & GROUND	931,650	931,650	943,620	11,970	1.3%
CONSULTING	49,500	49,500	49,500	0	0.0%
CONTRACTUAL	14,601,370	13,896,060	15,762,370	1,161,000	8.0%
RESERVES/RECOVERIES	12,552,790	12,552,790	12,778,910	226,120	1.8%
COST ALLOCATIONS	1,419,460	1,488,780	1,275,130	(144,330)	(10.2)%
FINANCIAL	227,360	243,690	237,860	10,500	4.6%
RECOVERIES FROM CAPITAL	(3,914,620)	(3,914,620)	(3,709,200)	205,420	(5.2)%
TOTAL EXPENSES	90,581,310	85,045,600	91,441,190	859,880	0.9%
FEES & GENERAL	(6,386,190)	(6,386,190)	(6,504,790)	(118,600)	1.9%
GRANTS & SUBSIDIES	0	(210,960)	0	0	0.0%
RESERVES	(709,440)	(709,440)	(702,280)	7,160	(1.0)%
TOTAL REVENUES	(7,095,630)	(7,306,590)	(7,207,070)	(111,440)	1.6%
NET LEVY	83,485,680	77,739,010	84,234,120	748,440	0.9%

DIVISION STRUCTURE

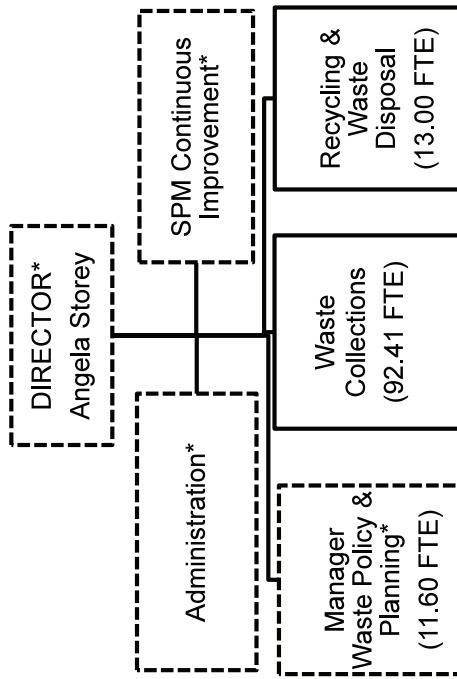

COMPLEMENT (FTE)	MANAGEMENT	OTHER	TOTAL	STAFF/MGT RATIO
2021	2.00	115.01	117.01	57.51:1
2022	2.00	115.01	117.01	57.51:1
CHANGE	0.00	0.00	0.00	

2022 Preliminary Tax Supported Operating Budget

BY SECTION

	2021	2021	2021	2022	2022	2022 Preliminary Budget vs. 2021 Restated	
	Restated Gross	Restated Net	Projected Actual Net	Preliminary Budget Gross	Preliminary Budget Net	Change \$	Change %
Recycling & Waste Disposal	21,726,710	6,944,210	3,628,610	22,452,140	7,431,960	487,750	7.0%
Waste Collections	35,806,650	35,764,650	36,798,960	38,100,000	38,065,070	2,300,420	6.4%
Waste Policy & Planning	1,559,250	1,545,750	1,644,310	1,611,330	1,597,790	52,040	3.4%
Director Waste	(150,000)	(150,000)	0	(150,000)	(150,000)	0	0.0%
Total Waste Management	58,942,610	44,104,610	42,071,880	62,013,470	46,944,820	2,840,210	6.4%

BY COST CATEGORY

	2021	2021	2022	2022 Preliminary Budget vs. 2021 Restated	
	Restated Budget	Projected Actual	Preliminary Budget	Change \$	Change %
EMPLOYEE RELATED COST	11,571,600	11,685,140	11,703,030	131,430	1.1%
MATERIAL & SUPPLY	480,910	485,420	476,110	(4,800)	(1.0)%
VEHICLE EXPENSES	2,208,010	2,360,360	2,320,180	112,170	5.1%
BUILDING & GROUND	1,128,520	1,003,080	1,128,150	(370)	(0.0)%
CONSULTING	1,090	1,090	1,090	0	0.0%
CONTRACTUAL	40,569,650	40,619,160	43,137,230	2,567,580	6.3%
AGENCIES & SUPPORT PAYMENTS	17,480	17,480	17,480	0	0.0%
RESERVES/RECOVERIES	1,975,280	1,981,610	2,109,930	134,650	6.8%
COST ALLOCATIONS	269,500	661,970	296,250	26,750	9.9%
FINANCIAL	824,020	824,020	824,020	0	0.0%
RECOVERIES FROM CAPITAL	(103,450)	(103,450)	0	103,450	(100.0)%
TOTAL EXPENSES	58,942,610	59,535,880	62,013,470	3,070,860	5.2%
FEES & GENERAL	(7,407,310)	(10,033,310)	(8,676,340)	(1,269,030)	17.1%
GRANTS & SUBSIDIES	(6,559,380)	(6,559,380)	(6,357,380)	202,000	(3.1)%
RESERVES	(871,310)	(871,310)	(34,930)	836,380	(96.0)%
TOTAL REVENUES	(14,838,000)	(17,464,000)	(15,068,650)	(230,650)	1.6%
NET LEVY	44,104,610	42,071,880	46,944,820	2,840,210	6.4%

CITY MANAGER'S OFFICE



DEPARTMENT STRUCTURE

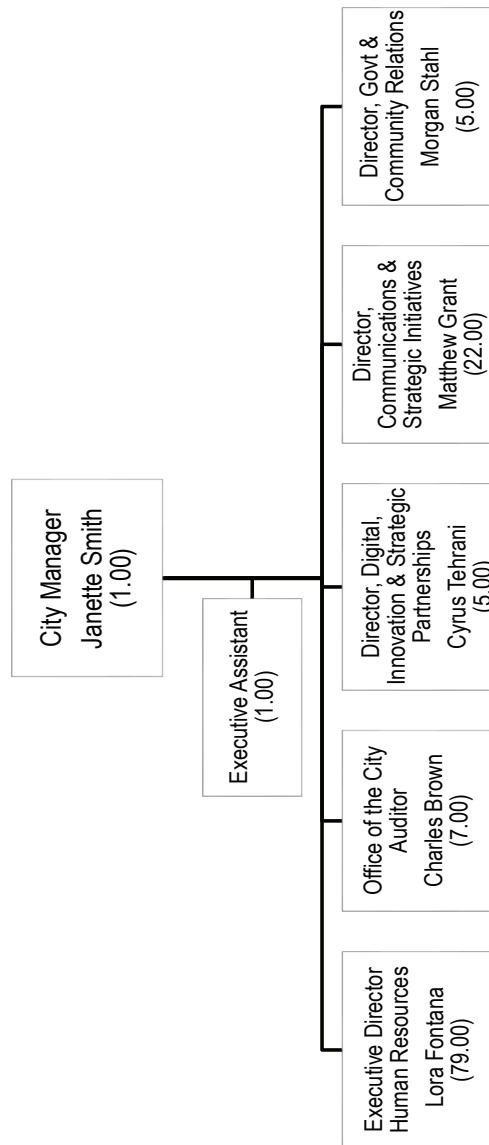

Complement (FTE)	Management	Other	Total	Staff to Management Ratio
2021	18.00	101.50	119.50	5.64:1
2022	21.00	99.00	120.00	4.71:1
Change	3.00	(2.50)	0.50	

COMPLEMENT (FTE)	MANAGEMENT	OTHER	TOTAL	STAFF/MGT RATIO
2021	18.00	101.50	119.50	5.64:1
2022	21.00	99.00	120.00	4.71:1
CHANGE	3.00	(2.50)	0.50	

2022 Preliminary Tax Supported Operating Budget

BY DIVISION

	2021	2021	2021	2022	2022	2022 Preliminary Budget vs. 2021 Restated	
	Restated Gross	Restated Net	Projected Actual Net	Preliminary Budget Gross	Preliminary Budget Net	Change \$	Change %
Office of the City Auditor	1,205,130	1,175,130	1,189,360	1,231,240	1,201,240	26,110	2.2%
CMO - Admin	209,270	209,270	349,780	233,520	233,520	24,250	11.6%
Communication & Strategic Initiatives	2,451,370	2,421,370	2,318,340	2,547,060	2,517,060	95,690	4.0%
Digital & Innovation Office	850,110	201,620	409,040	858,810	206,250	4,630	2.3%
Government & Community Relations	851,540	851,540	864,580	868,500	868,500	16,960	2.0%
Human Resources	10,196,740	8,163,030	7,544,990	10,541,910	8,589,490	426,460	5.2%
Total City Manager	15,764,160	13,021,960	12,676,090	16,281,040	13,616,060	594,100	4.6%

BY COST CATEGORY

	2021	2021	2022	2022 Preliminary Budget vs. 2021 Restated	
	Restated Budget	Projected Actual	Preliminary Budget	Change \$	Change %
EMPLOYEE RELATED COST	15,823,490	15,175,650	16,332,570	509,080	3.2%
MATERIAL & SUPPLY	628,210	614,810	628,210	0	0.0%
BUILDING & GROUND	468,230	286,280	507,370	39,140	8.4%
CONSULTING	320,790	378,570	320,790	0	0.0%
CONTRACTUAL	853,670	923,920	861,900	8,230	1.0%
RESERVES/RECOVERIES	441,470	436,430	466,420	24,950	5.7%
COST ALLOCATIONS	(3,478,510)	(3,478,510)	(3,543,020)	(64,510)	(1.9)%
FINANCIAL	680,600	681,150	680,600	0	0.0%
CAPITAL FINANCING	56,210	251,260	56,210	0	0.0%
RECOVERIES FROM CAPITAL	(30,000)	(30,000)	(30,000)	0	0.0%
TOTAL EXPENSES	15,764,160	15,239,560	16,281,050	516,890	3.3%
FEES & GENERAL	(682,990)	(504,270)	(687,060)	(4,070)	(0.6)%
RESERVES	(2,059,210)	(2,059,210)	(1,977,920)	81,290	3.9%
TOTAL REVENUES	(2,742,200)	(2,563,480)	(2,664,980)	77,220	2.8%
NET LEVY	13,021,960	12,676,080	13,616,070	594,110	4.6%

2022 Preliminary Tax Supported Operating Budget Multi-Year Budget Outlook

BY DIVISION

	2022 Preliminary Budget Gross	2022 Preliminary Budget Net	2023 Preliminary Gross	2023 Preliminary Net	2024 Preliminary Gross	2024 Preliminary Net	2025 Preliminary Gross	2025 Preliminary Net
Office of the City Auditor	1,231,240	1,201,240	1,259,040	1,229,040	1,284,370	1,254,370	1,306,480	1,276,480
CMO - Admin	233,520	233,520	243,810	243,810	252,810	252,810	262,760	262,760
Communication & Strategic Initiatives	2,547,060	2,517,060	2,617,490	2,587,490	2,681,960	2,651,960	2,740,340	2,710,340
Digital & Innovation Office	858,810	206,250	876,640	217,790	892,800	228,000	906,730	237,440
Government & Community Relations	868,500	868,500	884,650	884,650	899,330	899,330	911,950	911,950
Human Resources	10,541,910	8,589,490	10,743,340	8,776,680	10,921,990	8,941,120	11,075,480	9,094,610
Total City Manager	16,281,040	13,616,060	16,624,970	13,939,460	16,933,260	14,227,590	17,203,740	14,493,580

2022 Preliminary Tax Supported Operating Budget

BY SECTION - ADMIN AND DIGITAL OFFICE

	2021	2021	2021	2022	2022	2022 Preliminary Budget vs. 2021 Restated	
	Restated Gross	Restated Net	Projected Actual Net	Preliminary Budget Gross	Preliminary Budget Net	Change \$	Change %
City Manager Administration	209,270	209,270	349,780	233,520	233,520	24,250	11.6%
Total CMO - Admin	209,270	209,270	349,780	233,520	233,520	24,250	11.6%

BY COST CATEGORY - ADMIN AND DIGITAL OFFICE

	2021	2021	2022	2022 Preliminary Budget vs. 2021 Restated		
	Restated	Budget	Projected Actual	Preliminary Budget	Change \$	Change %
EMPLOYEE RELATED COST		473,740	572,360	493,210	19,470	4.1%
MATERIAL & SUPPLY		17,250	17,640	17,250	0	0.0%
BUILDING & GROUND		960	2,060	820	(140)	(14.6)%
CONTRACTUAL		1,240	42,790	1,240	0	0.0%
RESERVES/RECOVERIES		65,670	63,970	73,790	8,120	12.4%
COST ALLOCATIONS		(319,590)	(319,590)	(322,790)	(3,200)	(1.0)%
FINANCIAL		0	550	0	0	0.0%
RECOVERIES FROM CAPITAL		(30,000)	(30,000)	(30,000)	0	0.0%
TOTAL EXPENSES		209,270	349,780	233,520	24,250	11.6%
NET LEVY		209,270	349,780	233,520	24,250	11.6%

DIVISION STRUCTURE

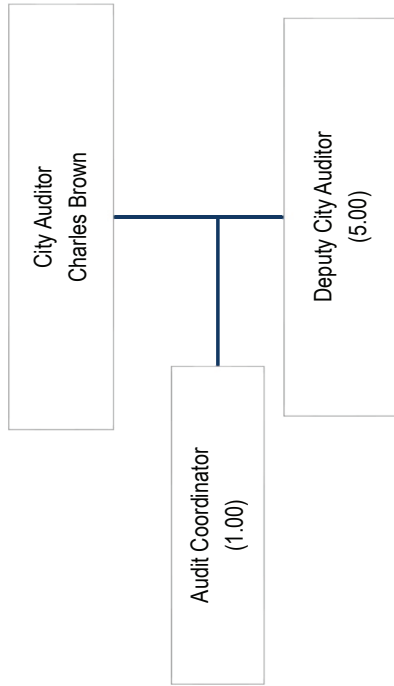

COMPLEMENT (FTE)	MANAGEMENT	OTHER	TOTAL	STAFF/MGT RATIO
2021	2.00	5.00	7.00	2.50:1
2022	2.00	5.00	7.00	2.50:1
CHANGE	0.00	0.00	0.00	

2022 Preliminary Tax Supported Operating Budget

BY SECTION

	2021 Restated Gross	2021 Restated Net	2021 Projected Actual Net	2022 Preliminary Budget Gross	2022 Preliminary Budget Net	2022 Preliminary Budget vs. 2021 Restated	
						Change \$	Change %
Audit Services	1,205,130	1,175,130	1,189,360	1,231,240	1,201,240	26,110	2.2%
Total Office of the City Auditor	1,205,130	1,175,130	1,189,360	1,231,240	1,201,240	26,110	2.2%

BY COST CATEGORY

	2021 Restated Budget	2021 Projected Actual	2022 Preliminary Budget	2022 Preliminary Budget vs. 2021 Restated	
				Change \$	Change %
EMPLOYEE RELATED COST	1,038,170	1,052,400	1,063,270	25,100	2.4%
MATERIAL & SUPPLY	2,390	2,390	2,390	0	0.0%
BUILDING & GROUND	1,770	1,770	1,640	(130)	(7.3)%
CONSULTING	30,000	30,000	30,000	0	0.0%
CONTRACTUAL	1,000	1,000	1,000	0	0.0%
RESERVES/RECOVERIES	74,590	74,590	75,730	1,140	1.5%
FINANCIAL	1,000	1,000	1,000	0	0.0%
CAPITAL FINANCING	56,210	56,210	56,210	0	0.0%
TOTAL EXPENSES	1,205,130	1,219,360	1,231,240	26,110	2.2%
RESERVES	(30,000)	(30,000)	(30,000)	0	0.0%
TOTAL REVENUES	(30,000)	(30,000)	(30,000)	0	0.0%
NET LEVY	1,175,130	1,189,360	1,201,240	26,110	2.2%

DIVISION STRUCTURE

COMMUNICATIONS & STRATEGIC INITIATIVES

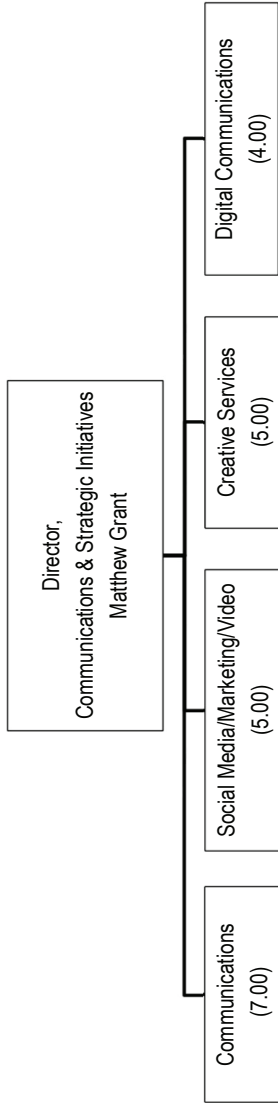

COMPLEMENT (FTE)	MANAGEMENT	OTHER	TOTAL	STAFF/MGT RATIO
2021	2.00	20.00	22.00	10.00:1
2022	4.00	18.00	22.00	4.50:1
CHANGE	2.00	(-2.00)	0.00	

2022 Preliminary Tax Supported Operating Budget

BY SECTION

	2021 Restated Gross	2021 Restated Net	2021 Projected Actual Net	2022 Preliminary Budget Gross	2022 Preliminary Budget Net	2022 Preliminary Budget vs. 2021 Restated	
						Change \$	Change %
Communications	2,451,370	2,421,370	2,318,340	2,547,060	2,517,060	95,690	4.0%
Total Communication & Strategic Initiatives	2,451,370	2,421,370	2,318,340	2,547,060	2,517,060	95,690	4.0%

BY COST CATEGORY

	2021 Restated Budget	2021 Projected Actual	2022 Preliminary Budget	2022 Preliminary Budget vs. 2021 Restated	
				Change \$	Change %
EMPLOYEE RELATED COST	2,604,280	2,519,250	2,703,180	98,900	3.8%
MATERIAL & SUPPLY	68,340	54,560	68,340	0	0.0%
BUILDING & GROUND	6,780	18,780	7,530	750	11.1%
CONSULTING	18,920	2,700	18,920	0	0.0%
CONTRACTUAL	24,690	24,690	24,690	0	0.0%
RESERVES/RECOVERIES	93,340	93,340	94,840	1,500	1.6%
COST ALLOCATIONS	(366,480)	(366,480)	(371,940)	(5,460)	(1.5)%
FINANCIAL	1,500	1,500	1,500	0	0.0%
TOTAL EXPENSES	2,451,370	2,348,340	2,547,060	95,690	3.9%
FEES & GENERAL	(30,000)	(30,000)	(30,000)	0	0.0%
TOTAL REVENUES	(30,000)	(30,000)	(30,000)	0	0.0%
NET LEVY	2,421,370	2,318,340	2,517,060	95,690	4.0%

DIVISION STRUCTURE

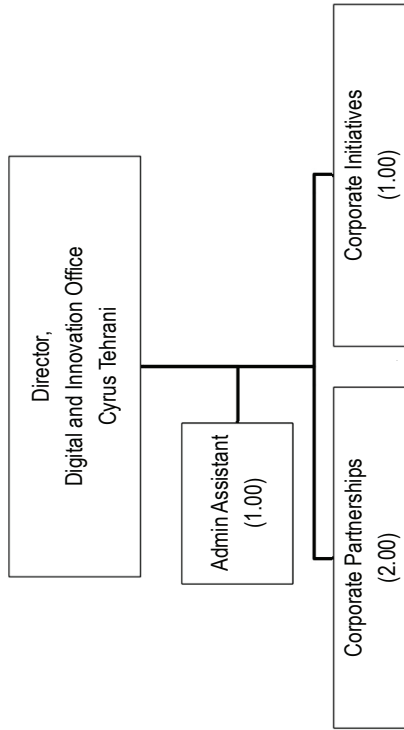

COMPLEMENT (FTE)	MANAGEMENT	OTHER	TOTAL	STAFF/MGT RATIO
2021	2.00	3.00	5.00	1.50:1
2022	2.00	3.00	5.00	1.50:1
CHANGE	0.00	0.00	0.00	

2022 Preliminary Tax Supported Operating Budget

BY SECTION

	2021	2021	2021	2022	2022	2022 Preliminary Budget vs. 2021 Restated	
	Restated Gross	Restated Net	Projected Actual Net	Preliminary Budget Gross	Preliminary Budget Net	Change \$	Change %
Corporate Initiatives	283,350	283,350	283,350	285,190	285,190	1,840	0.6%
Corporate Partnership	248,490	(400,000)	(192,580)	252,560	(400,000)	0	0.0%
Digital & Innovation Office Admin	318,270	318,270	318,270	321,060	321,060	2,790	0.9%
Total Digital & Innovation Office	850,110	201,620	409,040	858,810	206,250	4,630	2.3%

BY COST CATEGORY

	2021	2021	2022	2022 Preliminary Budget vs. 2021 Restated	
	Restated Budget	Projected Actual	Preliminary Budget	Change \$	Change %
EMPLOYEE RELATED COST	691,130	691,130	699,740	8,610	1.2%
MATERIAL & SUPPLY	18,010	18,010	18,010	0	0.0%
BUILDING & GROUND	1,120	1,120	1,310	190	17.0%
CONSULTING	20,760	20,760	20,760	0	0.0%
CONTRACTUAL	68,670	97,370	68,670	0	0.0%
RESERVES/RECOVERIES	21,970	21,970	21,870	(100)	(0.5)%
FINANCIAL	28,450	28,450	28,450	0	0.0%
TOTAL EXPENSES	850,110	878,810	858,810	8,700	1.0%
FEES & GENERAL	(648,490)	(469,770)	(652,560)	(4,070)	(0.6)%
TOTAL REVENUES	(648,490)	(469,770)	(652,560)	(4,070)	(0.6)%
NET LEVY	201,620	409,040	206,250	4,630	2.3%

DIVISION STRUCTURE

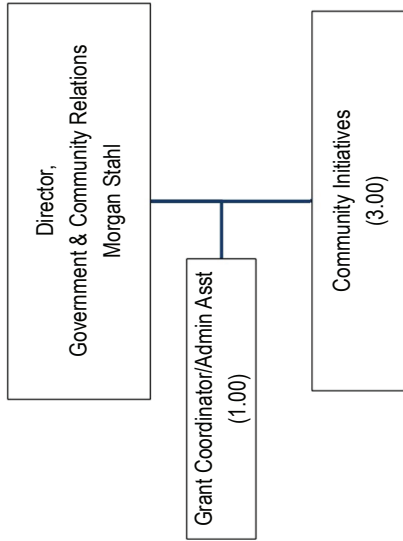

Complement (FTE)	Management	Other	Total	Staff to Management Ratio
2021	2.00	3.00	5.00	1.50:1
2022	2.00	3.00	5.00	1.50:1
Change	0.00	0.00	0.00	

GOVERNMENT & COMMUNITY RELATIONS

COMPLEMENT (FTE)	MANAGEMENT	OTHER	TOTAL	STAFF/MGT RATIO
2021	2.00	3.00	5.00	1.50:1
2022	2.00	3.00	5.00	1.50:1
CHANGE	0.00	0.00	0.00	

2022 Preliminary Tax Supported Operating Budget

BY SECTION

	2021		2021	2022		2022 Preliminary Budget vs. 2021 Restated	
	Restated Gross	Restated Net	Projected Actual Net	Preliminary Budget Gross	Preliminary Budget Net	Change \$	Change %
Government & Community Relations	530,460	530,460	415,150	542,470	542,470	12,010	2.3%
Community Initiatives	321,080	321,080	449,430	326,030	326,030	4,950	1.5%
Total Government & Community Relations	851,540	851,540	864,580	868,500	868,500	16,960	2.0%

BY COST CATEGORY

	2021	2021	2022	2022 Preliminary Budget vs. 2021 Restated	
	Restated Budget	Projected Actual	Preliminary Budget	Change \$	Change %
EMPLOYEE RELATED COST	610,530	552,800	622,900	12,370	2.0%
MATERIAL & SUPPLY	4,550	4,550	4,550	0	0.0%
BUILDING & GROUND	970	970	660	(310)	(32.0)%
CONSULTING	0	74,000	0	0	0.0%
CONTRACTUAL	213,380	213,380	213,380	0	0.0%
RESERVES/RECOVERIES	22,110	18,880	27,010	4,900	22.2%
TOTAL EXPENSES	851,540	864,580	868,500	16,960	2.0%
NET LEVY	851,540	864,580	868,500	16,960	2.0%

DIVISION STRUCTURE

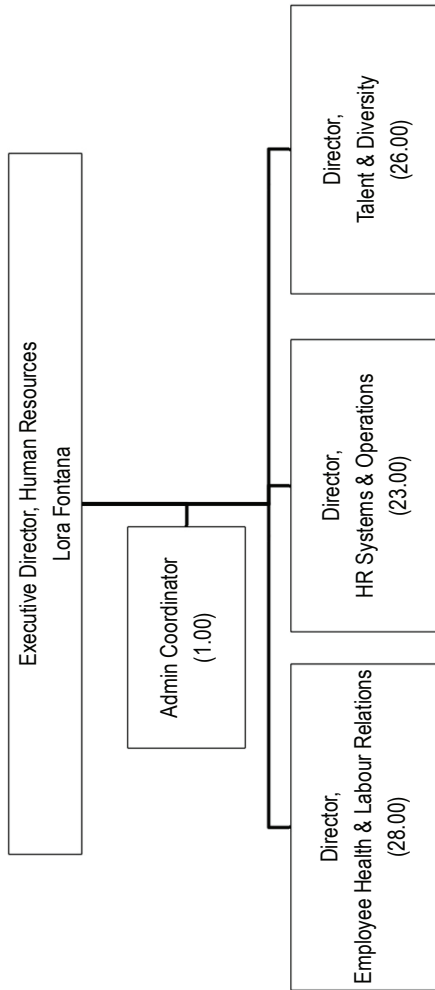

COMPLEMENT (FTE)	MANAGEMENT	OTHER	TOTAL	STAFF/MGT RATIO
2021	9.00	69.50	78.50	7.72:1
2022	10.00	69.00	79.00	6.90:1
CHANGE	1.00	(-0.50)	0.50	

2022 Preliminary Tax Supported Operating Budget

BY SECTION

	2021	2021	2021	2022	2022	2022 Preliminary Budget vs. 2021 Restated	
	Restated Gross	Restated Net	Projected Actual Net	Preliminary Budget Gross	Preliminary Budget Net	Change \$	Change %
Employee Health & Labour Relations	4,273,300	3,030,850	2,908,370	4,370,550	3,088,010	57,160	1.9%
HR Systems & Operations	2,887,170	2,260,270	1,889,110	2,956,730	2,312,470	52,200	2.3%
Human Resources Admin	265,910	245,050	405,340	260,020	238,890	(6,160)	(2.5)%
Talent & Diversity	2,770,360	2,626,860	2,342,170	2,954,620	2,950,120	323,260	12.3%
Total Human Resources	10,196,740	8,163,030	7,544,990	10,541,920	8,589,490	426,460	5.2%

BY COST CATEGORY

	2021	2021	2022	2022 Preliminary Budget vs. 2021 Restated	
	Restated Budget	Projected Actual	Preliminary Budget	Change \$	Change %
EMPLOYEE RELATED COST	10,405,640	9,787,710	10,750,260	344,620	3.3%
MATERIAL & SUPPLY	517,670	517,670	517,670	0	0.0%
BUILDING & GROUND	456,630	261,580	495,420	38,790	8.5%
CONSULTING	251,110	251,110	251,110	0	0.0%
CONTRACTUAL	544,690	544,690	552,920	8,230	1.5%
RESERVES/RECOVERIES	163,790	163,680	173,180	9,390	5.7%
COST ALLOCATIONS	(2,792,440)	(2,792,440)	(2,848,300)	(55,860)	(2.0)%
FINANCIAL	649,650	649,650	649,650	0	0.0%
CAPITAL FINANCING	0	195,050	0	0	0.0%
TOTAL EXPENSES	10,196,740	9,578,700	10,541,910	345,170	3.4%
FEES & GENERAL	(4,500)	(4,500)	(4,500)	0	0.0%
RESERVES	(2,029,210)	(2,029,210)	(1,947,920)	81,290	4.0%
TOTAL REVENUES	(2,033,710)	(2,033,710)	(1,952,420)	81,290	4.0%
NET LEVY	8,163,030	7,544,990	8,589,490	426,460	5.2%

CORPORATE SERVICES



DIVISION STRUCTURE

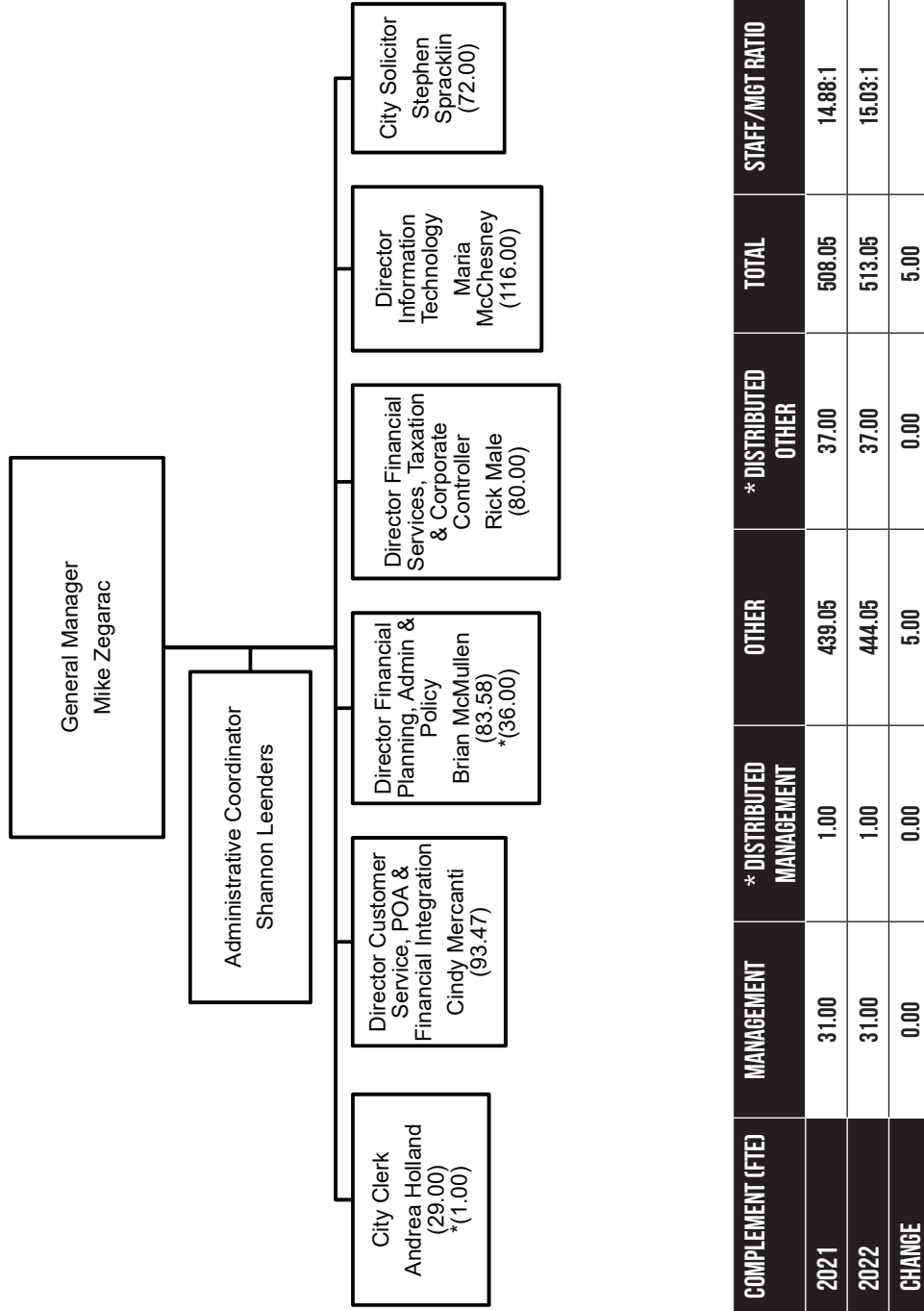

COMPLEMENT (FTE)	MANAGEMENT	* DISTRIBUTED MANAGEMENT	OTHER	* DISTRIBUTED OTHER	TOTAL	STAFF/MGT RATIO
2021	31.00	1.00	439.05	37.00	508.05	14.88:1
2022	31.00	1.00	444.05	37.00	513.05	15.03:1
CHANGE	0.00	0.00	5.00	0.00	5.00	

* Represents distributed staff whose budget are in operating departments.

2022 Preliminary Tax Supported Operating Budget

BY DIVISION

	2021	2021	2021	2022	2022	2022 Preliminary Budget vs. 2021 Restated	
	Restated Gross	Restated Net	Projected Actual Net	Preliminary Budget Gross	Preliminary Budget Net	Change \$	Change %
City Clerk's Office	3,580,670	2,995,070	3,061,105	3,800,800	3,168,430	173,360	5.8%
Customer Service POA and Finl Integration	12,395,640	5,824,460	5,793,566	12,606,240	5,959,640	135,180	2.3%
Financial Serv Taxation and Corp Controller	6,890,270	4,085,540	3,577,383	7,129,190	4,284,990	199,450	4.9%
Legal Services and Risk Management	4,164,670	4,008,810	3,730,333	4,097,440	3,939,580	(69,230)	(1.7)%
Corporate Services Administration	328,010	328,010	332,838	345,520	331,740	3,730	1.1%
Financial Planning Admin & Policy	6,729,220	5,219,620	5,016,164	6,885,630	5,371,300	151,680	2.9%
Information Technology	15,980,480	15,211,770	14,568,249	16,095,210	15,325,680	113,910	0.7%
Total Corporate Services	50,068,960	37,673,280	36,079,638	50,960,030	38,381,360	708,080	1.9%

BY COST CATEGORY

	2021	2021	2022	2022 Preliminary Budget vs. 2021 Restated	
	Restated Budget	Projected Actual Net	Preliminary Budget	Change \$	Change %
EMPLOYEE RELATED COST	48,565,020	47,898,397	50,251,660	1,686,640	3.5%
MATERIAL & SUPPLY	10,220,610	10,400,743	10,735,920	515,310	5.0%
VEHICLE EXPENSES	16,310	16,310	21,000	4,690	28.8%
BUILDING & GROUND	463,770	461,143	470,460	6,690	1.4%
CONSULTING	65,760	55,760	65,760	0	0.0%
CONTRACTUAL	4,591,970	4,583,896	4,753,100	161,130	3.5%
RESERVES/RECOVERIES	(3,723,390)	(3,590,026)	(4,812,360)	(1,088,970)	29.2%
COST ALLOCATIONS	(13,315,680)	(13,792,969)	(13,686,820)	(371,140)	2.8%
FINANCIAL	3,344,520	2,770,763	3,344,420	(100)	(0.0)%
CAPITAL FINANCING	1,959,620	1,959,620	1,959,620	0	0.0%
RECOVERIES FROM CAPITAL	(2,119,550)	(2,119,550)	(2,142,730)	(23,180)	1.1%
TOTAL EXPENSES	50,068,960	48,644,087	50,960,030	891,070	1.8%
FEES & GENERAL	(10,851,850)	(10,356,630)	(11,034,840)	(182,990)	1.7%
TAX & RATES	(618,000)	(770,000)	(618,000)	0	0.0%
RESERVES	(925,830)	(1,437,819)	(925,830)	0	0.0%
TOTAL REVENUES	(12,395,680)	(12,564,449)	(12,578,670)	(182,990)	1.5%
NET LEVY	37,673,280	36,079,638	38,381,360	708,080	1.9%

2022 Preliminary Tax Supported Operating Budget Multi-Year Budget Outlook

BY DIVISION

	2022 Preliminary Budget Gross	2022 Preliminary Budget Net	2023 Preliminary Gross	2023 Preliminary Net	2024 Preliminary Gross	2024 Preliminary Net	2025 Preliminary Gross	2025 Preliminary Net
City Clerk's Office	3,800,800	3,168,430	3,870,250	3,236,490	3,947,800	3,312,620	4,019,140	3,383,960
Customer Service POA and Finl Integration	12,606,240	5,959,640	12,854,410	6,122,340	13,066,180	6,260,330	13,259,090	6,384,540
Financial Serv Taxation and Corp Controller	7,129,190	4,284,990	7,283,770	4,419,730	7,424,680	4,529,810	7,561,320	4,637,100
Legal Services and Risk Management	4,097,440	3,939,580	4,247,520	4,087,620	4,355,620	4,193,640	4,429,280	4,267,300
Corporate Services Administration	345,520	331,740	354,090	340,310	360,610	346,830	365,420	351,640
Financial Planning Admin & Policy	6,885,630	5,371,300	7,130,260	5,611,080	7,287,660	5,763,740	7,469,870	5,943,850
Information Technology	16,095,210	15,325,680	16,555,800	15,785,440	16,776,620	16,005,400	16,953,400	16,182,180
Total Corporate Services	50,960,030	38,381,360	52,296,100	39,603,010	53,219,170	40,412,370	54,057,520	41,150,570

2022 Preliminary Tax Supported Operating Budget

BY SECTION - ADMINISTRATION

	2021 Restated Gross	2021 Restated Net	2021 Projected Actual Net	2022 Preliminary Budget Gross	2022 Preliminary Budget Net	2022 Preliminary Budget vs. 2021 Restated	
						Change \$	Change %
General Manager's Office	328,010	328,010	332,838	345,520	331,740	3,730	1.1%
Total Corporate Services Administration	328,010	328,010	332,838	345,520	331,740	3,730	1.1%

BY COST CATEGORY - ADMINISTRATION

	2021 Restated Budget	2021 Projected Actual	2022 Preliminary Budget	2022 Preliminary Budget vs. 2021 Restated	
				Change \$	Change %
EMPLOYEE RELATED COST	404,170	419,288	424,100	19,930	4.9%
MATERIAL & SUPPLY	3,430	3,430	3,430	0	0.0%
BUILDING & GROUND	320	320	330	10	3.1%
CONSULTING	25,000	15,000	25,000	0	0.0%
CONTRACTUAL	5,900	5,900	5,900	0	0.0%
RESERVES/RECOVERIES	15,160	14,870	15,910	750	4.9%
COST ALLOCATIONS	(133,970)	(133,970)	(136,650)	(2,680)	2.0%
FINANCIAL	8,000	8,000	7,500	(500)	(6.3)%
TOTAL EXPENSES	328,010	332,838	345,520	17,510	5.3%
FEES & GENERAL	0	0	(13,780)	(13,780)	100.0%
TOTAL REVENUES	0	0	(13,780)	(13,780)	100.0%
NET LEVY	328,010	332,838	331,740	3,730	1.1%

DIVISION STRUCTURE

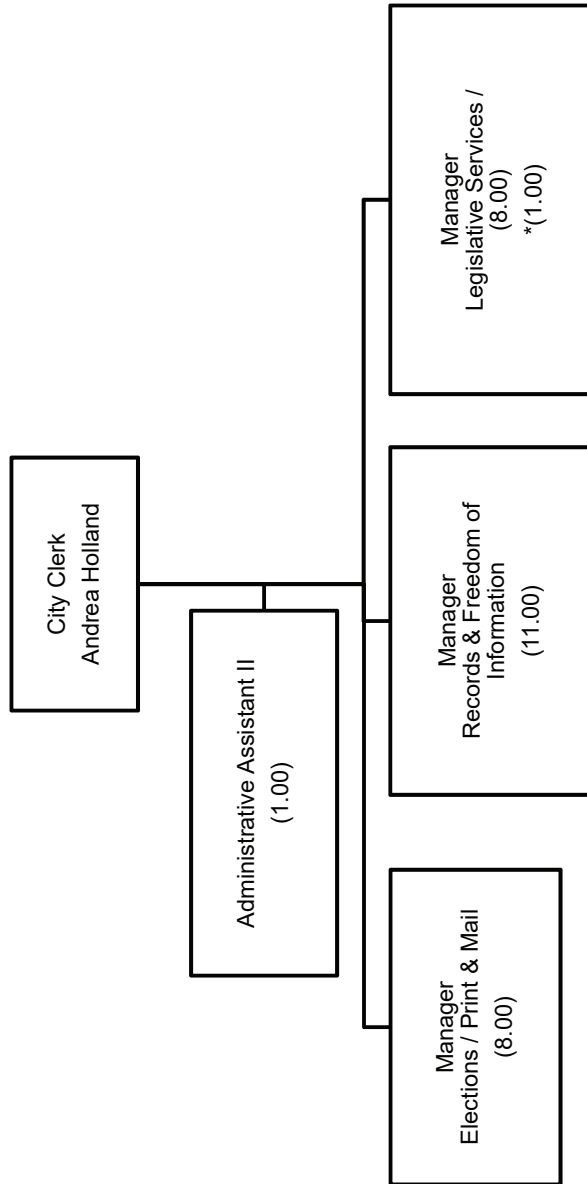

COMPLEMENT (FTE)	MANAGEMENT	OTHER	* OTHER DISTRIBUTED	TOTAL	STAFF/MGT RATIO
2021	4.00	25.00	1.00	30.00	6.50:1
2022	4.00	25.00	1.00	30.00	6.50:1
CHANGE	0.00	0.00	0.00	0.00	

* Represents distributed staff whose budget are in operating departments.

2022 Preliminary Tax Supported Operating Budget

BY SECTION

	2021	2021	2021	2022	2022	2022 Preliminary Budget vs. 2021 Restated	
	Restated Gross	Restated Net	Projected Actual Net	Preliminary Budget Gross	Preliminary Budget Net	Change \$	Change %
City Clerk - Admin	425,050	425,050	448,421	450,650	450,650	25,600	6.0%
Elections	711,480	711,480	711,480	822,890	822,890	111,410	15.7%
Legislative Support	905,650	855,650	866,994	917,200	866,140	10,490	1.2%
Print & Mail	400,940	400,940	504,210	420,710	420,710	19,770	4.9%
Records	1,137,550	601,950	530,000	1,189,350	608,040	6,090	1.0%
Total City Clerk's Office	3,580,670	2,995,070	3,061,105	3,800,800	3,168,430	173,360	5.8%

BY COST CATEGORY

	2021	2021	2022	2022 Preliminary Budget vs. 2021 Restated	
	Restated Budget	Projected Actual	Preliminary Budget	Change \$	Change %
EMPLOYEE RELATED COST	2,756,240	2,691,594	2,814,130	57,890	2.1%
MATERIAL & SUPPLY	836,270	914,004	849,770	13,500	1.6%
VEHICLE EXPENSES	10,590	10,590	11,870	1,280	12.1%
BUILDING & GROUND	5,300	5,300	5,410	110	2.1%
CONTRACTUAL	131,530	131,788	131,530	0	0.0%
RESERVES/RECOVERIES	233,750	219,631	389,110	155,360	66.5%
COST ALLOCATIONS	(393,010)	(393,010)	(401,020)	(8,010)	2.0%
TOTAL EXPENSES	3,580,670	3,579,897	3,800,800	220,130	6.1%
FEES & GENERAL	(585,600)	(515,600)	(632,370)	(46,770)	8.0%
RESERVES	0	(3,192)	0	0	0.0%
TOTAL REVENUES	(585,600)	(518,792)	(632,370)	(46,770)	8.0%
NET LEVY	2,995,070	3,061,105	3,168,430	173,360	5.8%

DIVISION STRUCTURE

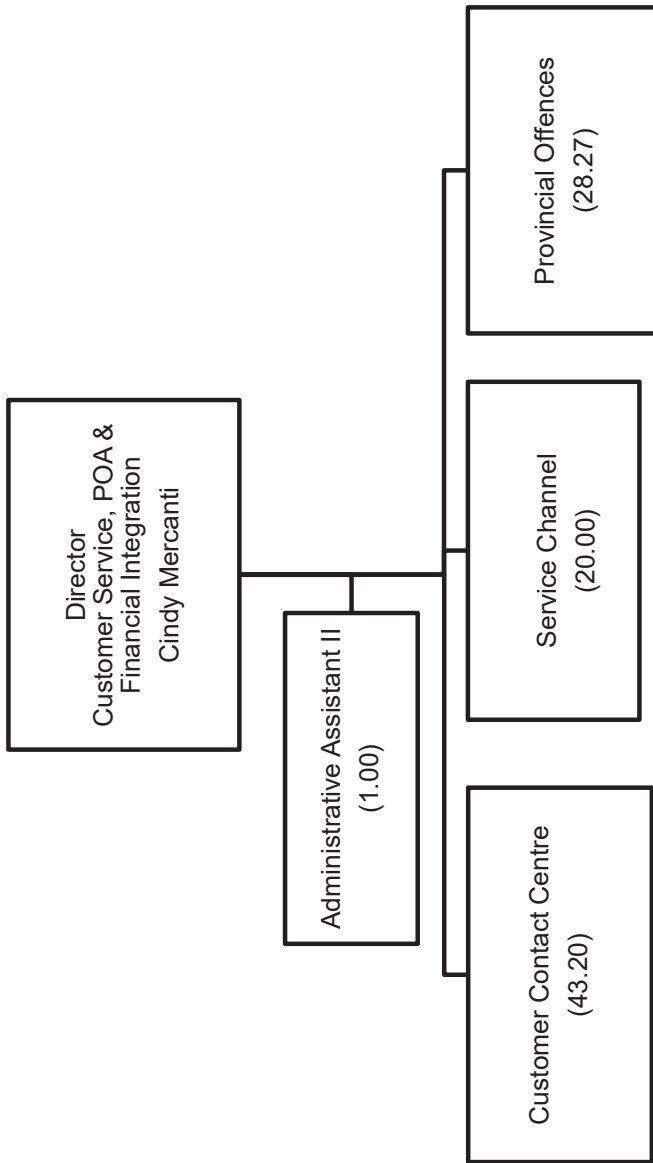

COMPLEMENT (FTE)	MANAGEMENT	OTHER	TOTAL	STAFF/MGT RATIO
2021	5.00	89.47	93.47	17.69:1
2022	5.00	89.47	93.47	17.69:1
CHANGE	0.00	0.00	0.00	

2022 Preliminary Tax Supported Operating Budget

BY SECTION

	2021		2021		2022		2022 Preliminary Budget vs. 2021 Restated	
	Restated Gross	Restated Net	Projected Actual Net	Projected Actual Net	Preliminary Budget Gross	Preliminary Budget Net	Change \$	Change %
Customer Contact Centre	3,488,800	3,488,800	3,438,111	3,438,111	3,567,800	3,567,800	79,000	2.3%
Customer Service - Administration	266,870	266,870	338,392	338,392	293,070	293,070	26,200	9.8%
Provincial Offences Administration	6,571,180	0	0	0	6,646,600	0	0	0.0%
Service Channel	2,068,790	2,068,790	2,017,063	2,017,063	2,098,770	2,098,770	29,980	1.4%
Total Customer Service POA and Finl Integration	12,395,640	5,824,460	5,793,566	5,793,566	12,606,240	5,959,640	135,180	2.3%

BY COST CATEGORY

	2021		2021		2022		2022 Preliminary Budget vs. 2021 Restated	
	Restated	Budget	Projected Actual	Projected Actual	Preliminary Budget	Preliminary Budget	Change \$	Change %
EMPLOYEE RELATED COST			8,155,200	8,075,159	8,386,470	8,386,470	231,270	2.8%
MATERIAL & SUPPLY			187,140	326,269	187,140	187,140	0	0.0%
BUILDING & GROUND			262,930	260,930	265,100	265,100	2,170	0.8%
CONSULTING			3,000	3,000	3,000	3,000	0	0.0%
CONTRACTUAL			313,810	319,542	313,810	313,810	0	0.0%
RESERVES/RECOVERIES			2,215,300	2,327,291	2,276,930	2,276,930	61,630	2.8%
COST ALLOCATIONS			(1,742,670)	(1,889,867)	(1,827,140)	(1,827,140)	(84,470)	4.8%
FINANCIAL			1,425,930	785,882	1,425,930	1,425,930	0	0.0%
CAPITAL FINANCING			1,575,000	1,575,000	1,575,000	1,575,000	0	0.0%
TOTAL EXPENSES			12,395,640	11,783,206	12,606,240	12,606,240	210,600	1.7%
FEES & GENERAL			(6,571,180)	(5,989,640)	(6,646,600)	(6,646,600)	(75,420)	1.1%
TOTAL REVENUES			(6,571,180)	(5,989,640)	(6,646,600)	(6,646,600)	(75,420)	1.1%
NET LEVY			5,824,460	5,793,566	5,959,640	5,959,640	135,180	2.3%

DIVISION STRUCTURE

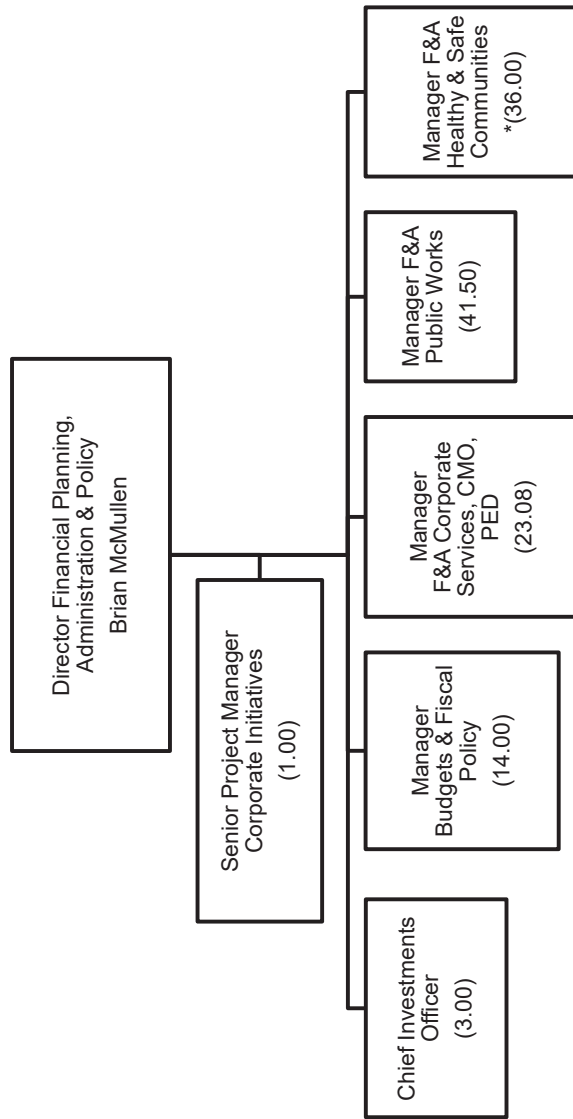

COMPLEMENT (FTE)	MANAGEMENT	*MANAGEMENT DISTRIBUTED	OTHER	* OTHER DISTRIBUTED	TOTAL	STAFF/MGT RATIO
2021	5.00	1.00	78.58	35.00	119.58	18.93:1
2022	5.00	1.00	78.58	35.00	119.58	18.93:1
CHANGE	0.00	0.00	0.00	0.00	0.00	

* Represents distributed staff whose budget are in operating departments

2022 Preliminary Tax Supported Operating Budget

BY SECTION

	2021	2021	2021	2022	2022	2022 Preliminary Budget vs. 2021 Restated	
	Restated Gross	Restated Net	Projected Actual Net	Preliminary Budget Gross	Preliminary Budget Net	Change \$	Change %
Budgets & Fiscal Policy	866,490	622,990	623,184	835,570	592,070	(30,920)	(5.0)%
Admin Financial Policy & Planning	87,610	87,610	196,658	90,320	90,320	2,710	3.1%
Finance	4,720,220	4,625,660	4,316,122	4,891,020	4,794,230	168,570	3.6%
Investments	1,054,900	(116,640)	(119,800)	1,068,720	(105,320)	11,320	(9.7)%
Total Financial Planning Admin & Policy	6,729,220	5,219,620	5,016,164	6,885,630	5,371,300	151,680	2.9%

BY COST CATEGORY

	2021	2021	2022	2022 Preliminary Budget vs. 2021 Restated			
	Restated	Budget	Projected Actual	Preliminary Budget	Change \$	Change %	
EMPLOYEE RELATED COST			8,570,510	8,414,536	8,855,380	284,870	3.3%
MATERIAL & SUPPLY			38,480	33,835	38,380	(100)	(0.3)%
BUILDING & GROUND			39,550	39,550	40,350	800	2.0%
CONSULTING			20,700	20,700	20,700	0	0.0%
CONTRACTUAL			110,950	107,418	110,980	30	0.0%
RESERVES/RECOVERIES			240,610	234,452	246,590	5,980	2.5%
COST ALLOCATIONS			(1,774,340)	(1,674,514)	(1,885,580)	(111,240)	6.3%
FINANCIAL			304,310	322,310	304,310	0	0.0%
RECOVERIES FROM CAPITAL			(821,550)	(821,550)	(845,480)	(23,930)	2.9%
TOTAL EXPENSES			6,729,220	6,676,737	6,885,630	156,410	2.3%
FEES & GENERAL			(1,404,100)	(1,404,100)	(1,408,830)	(4,730)	0.3%
RESERVES			(105,500)	(256,473)	(105,500)	0	0.0%
TOTAL REVENUES			(1,509,600)	(1,660,573)	(1,514,330)	(4,730)	0.3%
NET LEVY			5,219,620	5,016,164	5,371,300	151,680	2.9%

DIVISION STRUCTURE

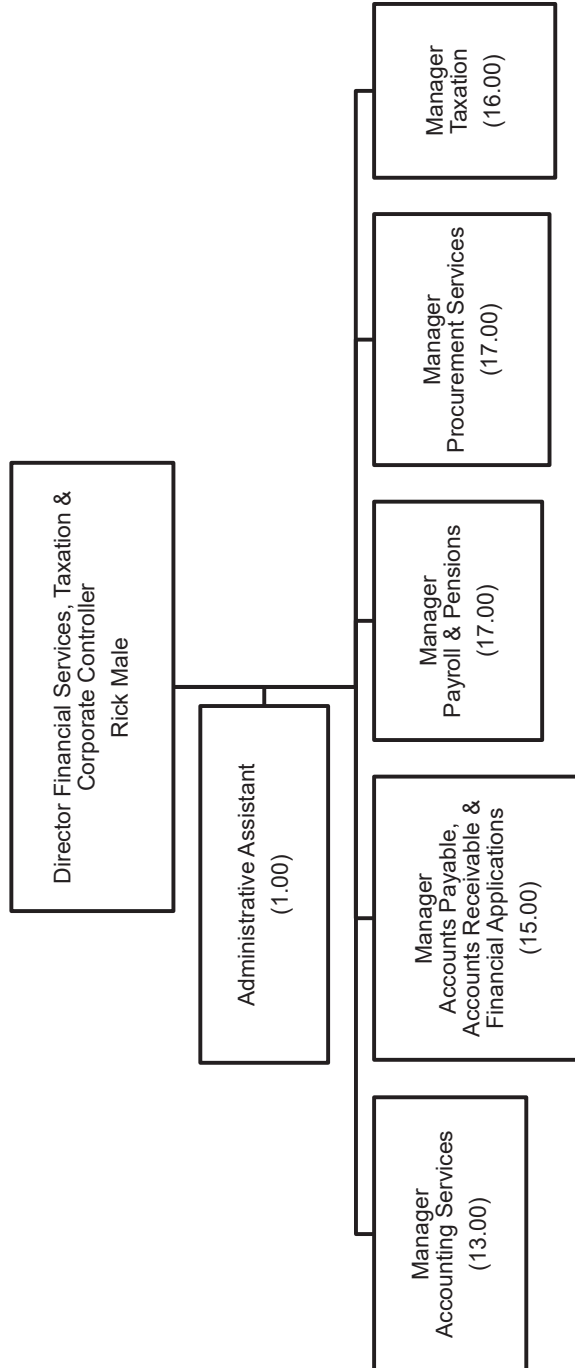

COMPLEMENT (FTE)	MANAGEMENT	OTHER	TOTAL	STAFF/MGT RATIO
2021	6.00	74.00	80.00	12.33:1
2022	6.00	74.00	80.00	12.33:1
CHANGE	0.00	0.00	0.00	

2022 Preliminary Tax Supported Operating Budget

BY SECTION

	2021	2021	2021	2022	2022	2022 Preliminary Budget vs. 2021	
	Restated Gross	Restated Net	Projected Actual Net	Preliminary Budget Gross	Preliminary Budget Net	Restated	
						Change \$	Change %
Accounts Payable	453,960	412,960	410,960	364,250	322,430	(90,530)	(21.9)%
Accounts Receivable	177,180	177,180	175,180	175,010	175,010	(2,170)	(1.2)%
Financial Accounting Services	770,720	725,100	669,041	800,100	754,480	29,380	4.1%
Financial Application Support	360,350	360,350	360,350	494,780	494,780	134,430	37.3%
Financial Services Admin	354,520	354,520	468,749	368,130	368,130	13,610	3.8%
Payroll and Pensions	1,094,050	967,160	977,957	1,132,990	1,005,500	38,340	4.0%
Procurement	1,161,320	902,750	818,425	1,213,470	949,730	46,980	5.2%
Taxation	2,518,170	185,520	(303,279)	2,580,460	214,930	29,410	15.9%
Total Financial Serv Taxation and Corp Controller	6,890,270	4,085,540	3,577,383	7,129,190	4,284,990	199,450	4.9%

BY COST CATEGORY

	2021	2021	2022	2022 Preliminary Budget vs. 2021	
	Restated Budget	Projected Actual	Preliminary Budget	Restated	
				Change \$	Change %
EMPLOYEE RELATED COST	7,708,610	7,552,833	7,937,140	228,530	3.0%
MATERIAL & SUPPLY	632,650	613,642	636,000	3,350	0.5%
BUILDING & GROUND	17,620	16,993	18,230	610	3.5%
CONTRACTUAL	98,330	74,844	98,330	0	0.0%
RESERVES/RECOVERIES	489,930	478,680	508,920	18,990	3.9%
COST ALLOCATIONS	(2,013,590)	(1,992,760)	(2,027,290)	(13,700)	0.7%
FINANCIAL	64,800	54,281	65,200	400	0.6%
CAPITAL FINANCING	303,000	303,000	303,000	0	0.0%
RECOVERIES FROM CAPITAL	(411,080)	(411,080)	(410,340)	740	(0.2)%
TOTAL EXPENSES	6,890,270	6,690,433	7,129,190	238,920	3.5%
FEES & GENERAL	(2,043,110)	(2,199,430)	(2,082,580)	(39,470)	1.9%
TAX & RATES	(618,000)	(770,000)	(618,000)	0	0.0%
RESERVES	(143,620)	(143,620)	(143,620)	0	0.0%
TOTAL REVENUES	(2,804,730)	(3,113,050)	(2,844,200)	(39,470)	1.4%
NET LEVY	4,085,540	3,577,383	4,284,990	199,450	4.9%

INFORMATION TECHNOLOGY

DIVISION STRUCTURE

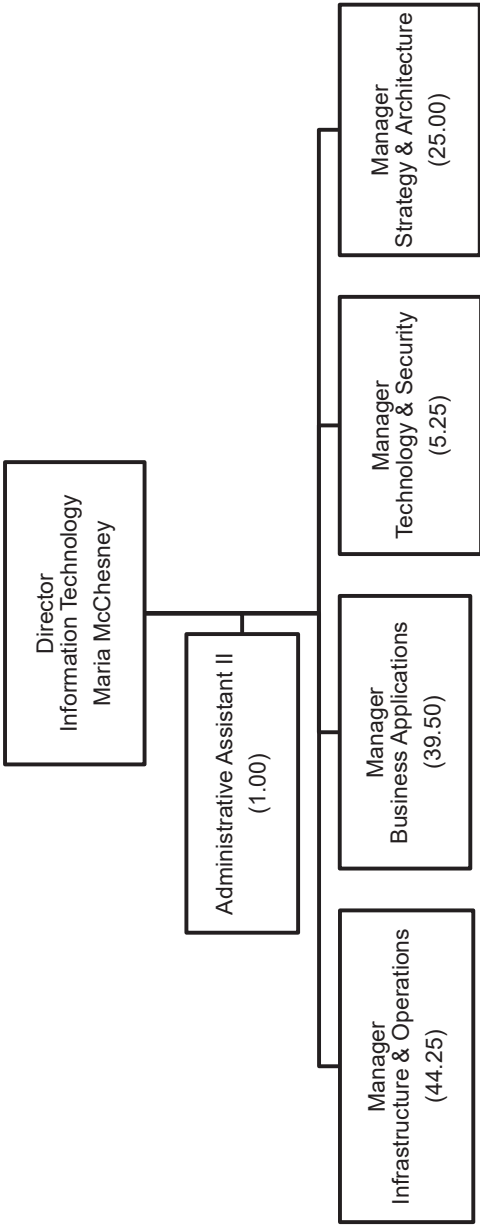

COMPLEMENT (FTE)	MANAGEMENT	OTHER	TOTAL	STAFF/MGT RATIO
2021	5.00	111.00	116.00	22.2:1
2022	5.00	111.00	116.00	22.2:1
CHANGE	0.00	0.00	0.00	

2022 Preliminary Tax Supported Operating Budget

BY SECTION

	2021	2021	2021	2022	2022	2022 Preliminary Budget vs. 2021	
	Restated Gross	Restated Net	Projected Actual Net	Preliminary Budget Gross	Preliminary Budget Net	Restated	
						Change \$	Change %
Business Applications	8,148,580	8,143,020	8,073,191	7,772,300	7,766,630	(376,390)	(4.6)%
Equipment & Maintenance	165,150	0	0	165,150	0	0	0.0%
Infrastructure & Operations	10,691,570	10,095,010	9,440,271	11,247,490	10,650,230	555,220	5.5%
IP Telephony	1,170	0	0	1,170	0	0	0.0%
IT - Admin	(4,137,850)	(4,138,120)	(3,986,674)	(4,226,430)	(4,226,710)	(88,590)	2.1%
Technology & Security	1,111,860	1,111,860	1,041,461	1,135,530	1,135,530	23,670	2.1%
Total Information Technology	15,980,480	15,211,770	14,568,249	16,095,210	15,325,680	113,910	0.7%

BY COST CATEGORY

	2021	2021	2022	2022 Preliminary Budget vs. 2021	
	Restated Budget	Projected Actual	Preliminary Budget	Restated	
				Change \$	Change %
EMPLOYEE RELATED COST	12,502,110	12,180,543	12,635,380	133,270	1.1%
MATERIAL & SUPPLY	8,387,690	8,377,538	8,848,780	461,090	5.5%
VEHICLE EXPENSES	5,720	5,720	9,130	3,410	59.6%
BUILDING & GROUND	121,780	121,780	124,200	2,420	2.0%
CONSULTING	12,060	12,060	12,060	0	0.0%
CONTRACTUAL	3,885,650	3,889,134	4,043,020	157,370	4.1%
RESERVES/RECOVERIES	(3,754,110)	(3,746,910)	(4,307,230)	(553,120)	14.7%
COST ALLOCATIONS	(6,518,940)	(6,518,940)	(6,608,650)	(89,710)	1.4%
FINANCIAL	1,338,520	1,338,520	1,338,520	0	0.0%
TOTAL EXPENSES	15,980,480	15,659,445	16,095,210	114,730	0.7%
FEES & GENERAL	(92,000)	(92,000)	(92,820)	(820)	0.9%
RESERVES	(676,710)	(999,196)	(676,710)	0	0.0%
TOTAL REVENUES	(768,710)	(1,091,196)	(769,530)	(820)	0.1%
NET LEVY	15,211,770	14,568,249	15,325,680	113,910	0.7%

LEGAL SERVICES

DIVISION STRUCTURE

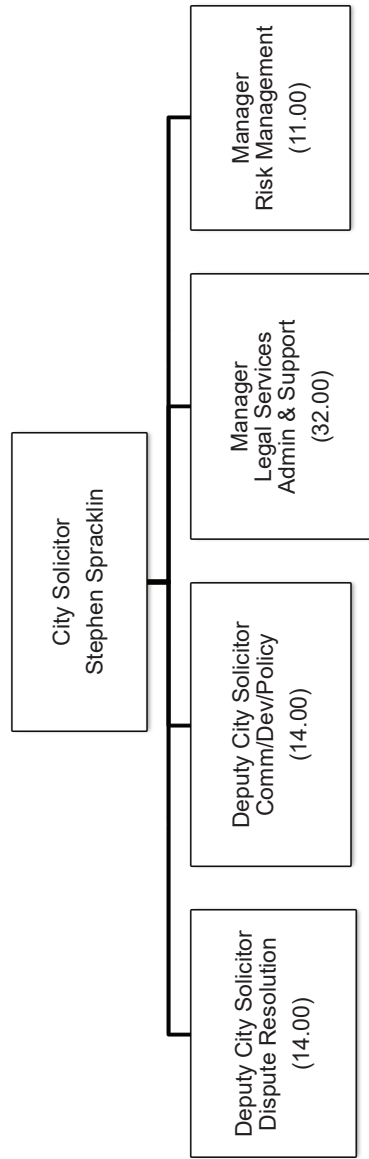

COMPLEMENT (FTE)	MANAGEMENT	OTHER	TOTAL	STAFF/MGT RATIO
2021	5.00	62.00	67.00	12.6:1
2022	5.00	67.00	72.00	13.4:1
CHANGE	0.00	5.00	5.00	

2022 Preliminary Tax Supported Operating Budget

BY SECTION

	2021 Restated Gross	2021 Restated Net	2021 Projected Actual Net	2022 Preliminary Budget Gross	2022 Preliminary Budget Net	2022 Preliminary Budget vs. 2021 Restated	
						Change \$	Change %
Legal Services	4,083,260	3,927,400	3,730,333	4,097,440	3,939,580	12,180	0.3%
Risk Management	81,410	81,410	0	0	0	(81,410)	(100.0)%
Total Legal Services and Risk Management	4,164,670	4,008,810	3,730,333	4,097,440	3,939,580	(69,230)	(1.7)%

BY COST CATEGORY

	2021 Restated Budget	2021 Projected Actual	2022 Preliminary Budget	2022 Preliminary Budget vs. 2021 Restated	
				Change \$	Change %
EMPLOYEE RELATED COST	8,468,190	8,564,444	9,199,080	730,890	8.6%
MATERIAL & SUPPLY	134,950	132,025	172,430	37,480	27.8%
BUILDING & GROUND	16,270	16,270	16,840	570	3.5%
CONSULTING	5,000	5,000	5,000	0	0.0%
CONTRACTUAL	45,800	55,270	49,530	3,730	8.1%
RESERVES/RECOVERIES	(3,164,040)	(3,118,040)	(3,942,600)	(778,560)	24.6%
COST ALLOCATIONS	(739,160)	(1,170,260)	(800,500)	(61,340)	8.3%
FINANCIAL	202,960	261,770	202,960	0	0.0%
CAPITAL FINANCING	81,620	81,620	81,620	0	0.0%
RECOVERIES FROM CAPITAL	(886,920)	(886,920)	(886,920)	0	0.0%
TOTAL EXPENSES	4,164,670	3,941,179	4,097,440	(67,230)	(1.6)%
FEES & GENERAL	(155,860)	(155,860)	(157,860)	(2,000)	1.3%
RESERVES	0	(54,986)	0	0	0.0%
TOTAL REVENUES	(155,860)	(210,846)	(157,860)	(2,000)	1.3%
NET LEVY	4,008,810	3,730,333	3,939,580	(69,230)	(1.7)%

OTHERS



2022 Preliminary Tax Supported Operating Budget

BY DIVISION

	2021	2021	2021	2022	2022	2022 Preliminary Budget vs. 2021 Restated	
	Restated Gross	Restated Net	Projected Actual Net	Preliminary Budget Gross	Preliminary Budget Net	Change \$	Change %
Legislative General	(379,020)	(379,020)	(255,910)	(361,980)	(361,980)	17,040	(4.5)%
Mayors Office	1,192,900	1,192,900	1,152,450	1,211,420	1,211,420	18,520	1.6%
Volunteer Committee	124,650	120,650	120,650	124,650	120,650	0	0.0%
Ward Budgets	4,236,600	4,236,600	4,236,600	4,314,420	4,314,420	77,820	1.8%
Total Legislative	5,175,130	5,171,130	5,253,790	5,288,510	5,284,510	113,380	2.2%

BY COST CATEGORY

	2021	2021	2022	2022 Preliminary Budget vs. 2021 Restated		
	Restated	Budget	Projected Actual	Preliminary Budget	Change \$	Change %
EMPLOYEE RELATED COST		4,214,900	4,241,730	4,317,170	102,270	2.4%
MATERIAL & SUPPLY		974,860	1,008,860	960,760	(14,100)	(1.4)%
VEHICLE EXPENSES		4,060	4,060	4,140	80	2.0%
BUILDING & GROUND		81,780	126,720	81,970	190	0.2%
CONSULTING		54,190	44,190	54,190	0	0.0%
CONTRACTUAL		219,530	203,530	219,530	0	0.0%
AGENCIES & SUPPORT PAYMENTS		19,070	11,570	19,070	0	0.0%
RESERVES/RECOVERIES		406,250	395,640	440,740	34,490	8.5%
COST ALLOCATIONS		(954,760)	(954,760)	(964,310)	(9,550)	(1.0)%
FINANCIAL		155,250	176,250	155,250	0	0.0%
TOTAL EXPENSES		5,175,130	5,257,790	5,288,510	113,380	2.2%
RESERVES		(4,000)	(4,000)	(4,000)	0	0.0%
TOTAL REVENUES		(4,000)	(4,000)	(4,000)	0	0.0%
NET LEVY		5,171,130	5,253,790	5,284,510	113,380	2.2%

2022 Preliminary Tax Supported Operating Budget

BY SECTION

	2021	2021	2021	2022	2022	2022 Preliminary Budget vs. 2021 Restated	
	Restated Gross	Restated Net	Projected Actual Net	Preliminary Budget Gross	Preliminary Budget Net	Change \$	Change %
Corporate Initiatives	3,997,920	3,354,610	5,897,210	7,826,370	7,639,770	4,285,160	127.7%
Corporate Pensions Benefits & Contingency	15,653,960	15,653,960	19,653,960	15,785,390	15,785,390	131,430	0.8%
Total Non Program Expenditures	19,651,880	19,008,570	25,551,170	23,611,760	23,425,160	4,416,590	23.2%

BY COST CATEGORY

	2021	2021	2022	2022 Preliminary Budget vs. 2021 Restated	
	Restated Budget	Projected Actual	Preliminary Budget	Change \$	Change %
EMPLOYEE RELATED COST	13,413,960	17,413,960	8,040,880	(5,373,080)	(40.1)%
MATERIAL & SUPPLY	133,900	130,010	130,010	(3,890)	(2.9)%
CONTRACTUAL	487,740	487,740	3,877,200	3,389,460	694.9%
AGENCIES & SUPPORT PAYMENTS	20,000	20,000	20,000	0	0.0%
RESERVES/RECOVERIES	(13,542,470)	(13,542,470)	(10,160,970)	3,381,500	(25.0)%
COST ALLOCATIONS	(4,780)	0	0	4,780	(100.0)%
FINANCIAL	18,225,930	20,325,930	20,787,040	2,561,110	14.1%
CAPITAL FINANCING	917,600	917,600	917,600	0	0.0%
TOTAL EXPENSES	19,651,880	25,752,770	23,611,760	3,959,880	20.2%
FEES & GENERAL	(628,310)	(186,600)	(186,600)	441,710	(70.3)%
RESERVES	(15,000)	(15,000)	0	15,000	(100.0)%
TOTAL REVENUES	(643,310)	(201,600)	(186,600)	456,710	(71.0)%
NET LEVY	19,008,570	25,551,170	23,425,160	4,416,590	23.2%

OPERATING IMPACTS OF CAPITAL (2022 AND PRIOR)

	FCS20101		UPDATED		FTE
	(\$ 000's)	FTE's	Annualized	2022	
			(\$ 000's)		
Corporate Services					
Information Technology (IT)					
3502157101 Next Generation 9-1-1 (nG 9-1-1)	312.5	-	312.5	312.5	-
3502157202 IT Asset Management Program	357.0	2.0	357.0	357.0	2.0
3502157907 Business Systems and Services Continuity Plan	96.0	1.0	96.0	96.0	1.0
3502057203 Payment Card Systems Review	100.0	1.0	100.0	100.0	1.0
3501957906 IT Strategy - Strategic Theme IT Optimization	-	-	15.0	15.0	-
3501957910 Messaging (Email) Platform Migration	-	-	100.0	100.0	-
3502257203 Information Security Program	-	-	140.0	140.0	1.0
Corporate Services Administration					
2052255201 Administrative Penalties Expansion and Operational Enhancement Review	-	-	50.0	50.0	0.5
Customer Service & Provincial Offenses Office					
2052157002 Replacement of Integrated Court Offences Network and Collections	-	-	45	45	-
Total Corporate Services	865.50	4.00	1,215.50	1,215.50	5.50
Healthy and Safe Communities					
Hamilton Fire Department					
7402151102 SCBA Complete Unit Replacement	363.0	-	363.0	363.0	-
7401841801 Waterdown New Station	-	15.0	-	-	-
7402251102 HFD Technology	-	-	100.0	100.0	-
Hamilton Paramedic Service					
7642151102 Automated CPR Units	177	-	177	177	-
Recreation					
7102154701 Pickleball Courts at the Ancaster Senior Achievement Centre	-	-	2.5	2.5	-
Total Healthy and Safe Communities	540.00	15.00	642.50	642.50	-

OPERATING IMPACTS OF CAPITAL (2022 AND PRIOR)

	FCS20101		UPDATED		FTE
	(\$ 000's)	FTE's	Annualized	2022	
			(\$ 000's)		
<i>Planning & Economic Development</i>					
Commercial Districts and Small Business					
8201703706 Community Downtowns and BIAs	7.2	-	7.2	6.2	-
Transportation, Planning and Parking					
4032155744 TMP Modelling & Monitoring	-	-	30.0	30.0	0.25
4032155820 Sustainable Mobility Program	-	-	60.0	60.0	0.5
4032255242 Transportation Network Review and Implementation Plan	-	-	30.0	30.0	0.25
Tourism and Culture					
7202058201 Monument Restoration	-	-	27.1	27.1	.25
Total Planning & Economic Development	7.20	-	154.30	153.30	1.25
<u>Public Works Tax Funded</u>					
Corporate Facilities					
3541849003 Backflow Prevention for Various Facilities	120.0	-	-	-	-
Forestry & Horticulture					
4452153444 Tree Planting Program	21.2	-	21.2	21.2	-
O & M - Parks & Cemeteries					
4402156001 Leash Free Dog Park Program	2.0	-	2.0	2.0	-
4402151601 Equipment Acquisition (DC) Program	76.0	-	76.0	76.0	-
4402149003 Backflow Prevention for Various Parks Facilities	135.0	-	135.0	135.0	-
Open Space Development					
4401356801 Confederation Park Redevelopment	271.1	1.3	271.1	271.1	1.3
4401956906 Gatesbury Park	5.0	-	5.0	5.0	-
4402156002 Ryckman's Park Pathway	2.0	-	2.0	2.0	-
4402156111 Lancaster Heights - Developer Build	47.5	0.5	-	-	-
4401858800 Skatepark Facility - Recreation study implementation	11.0	-	11.0	11.0	-
4401956929 HRTMP Initiative 7-1 - Limeridge Mall Hydro Corridor Trail	35.0	-	35.0	35.0	-

OPERATING IMPACTS OF CAPITAL (2022 AND PRIOR)

	FCS20101		UPDATED		FTE
	(\$ 000's)	FTE's	Annualized	2022	
			(\$ 000's)		
Recreation Facilities					
7102054002 Confederation Park Sports Park Buildings	-	0.5	-	100.0	0.5
7101754706 Valley Park Community Centre Fit-up	150.0	1.0	150.0	150.0	1.0
7101754805 Sir Wilfrid Laurier Gymnasium Addition.	260.0	-	-	-	-
Roads					
4032119111 Highway 8 - Bond to Woodleys Lane	4.0	-	4.0	4.0	-
4662120531 APS - Accessible Pedestrian Signals	16.8	0.2	16.8	16.8	0.2
4662120126 New Traffic Signal - Nebo @ Twenty Rd	13.6	0.1	-	-	-
4662117124 On Street Bike Facilities	100.0	-	100.0	100.0	-
4662220223 New Traffic Signal - York @ Old Guelph	-	-	-	-	-
Transit Services					
5301785701 Transit Maintenance and Storage Facility (Cash Flow Project)	-	21.0	-	-	-
5302184102 Real-Time Operations Management	100.0	-	-	-	-
5302185803 Operator Washroom Conveniences and End of Line Rehab	310.0	-	-	-	-
5302249001 Operator Washroom Conveniences	-	-	-	-	-
5302185902 Transit Shelter Expansion Program	80.0	-	80.0	80.0	-
5301783700 HSR Bus Expansion Program - 10 Year Plan	1,190.0	14.0	-	-	-
5302083001 HSR Expansion Buses - Modal Split	2,143.0	21.0	-	-	-
West Harbour & Waterfront Strategic Initiatives					
4411606102 Pier 5-7 Boardwalk	-	0.3	-	-	0.3
Total Public Works Tax Funded	5,093.20	59.86	909.09	1,009.09	3.31
Total (FCS20101)	6,505.9	78.86	2,921.4	3,020.4	10.06

OPERATING IMPACTS OF CAPITAL (2022 AND PRIOR)

	FCS20101		UPDATED		
	(\$ 000's)	FTE's	Annualized	2022	
			(\$ 000's)	FTE	
2021 impacts (from 2020 Capital) Deferred to 2022:					
Healthy and Safe Communities					
Long Term Care Homes					
6301941003	WL - Radiant Heating Panel/Thermostat Controls	(6.0)	0.0	0.0	0.0
Public Works Tax Funded					
O & M - Parks & Cemeteries					
4402049004	Parkside Cemetery Development	73	73	73	0.83
Open Space Development					
4401756706	Roxborough Park Redevelopment	5.00	-	-	-
4402056010	Highland Road Park (Proposed) - Central Park Development	35.00	35.00	35.00	0.25
44020566918	Beasley Park Rehabilitation Phase 2 - Kelly Street Pedestrianization	12.00	-	-	-
4241409341	W4 Pipeline Trail	24.00	-	-	-
4401756703	Mountain Brow Path	32.00	-	-	-
Roads, Bridges, Sidewalks, Traffic					
4042057014	Drive Cam	95.00	-	-	-
4662020020	New Traffic Signal - Rymal Road at Arrowhead Drive	13.40	13.40	13.40	.05
4662020021	New Traffic Signal - Center Road at Concession 8	13.40	-	-	-
4662020023	New Traffic Signal - King at Kenilworth North Bound Off Ramp	13.40	-	-	-
	New Traffic Signal - 36 Dundas St E (Waterdown) 300m w/o Clappison Ave	13.40	13.40	13.40	.05
4662020026	New Traffic Signal - Lawrence @ Kenilworth Ramp - 652 Lawrence	13.40	-	-	-
4662020027	Ave				
4662020028	New Traffic Signal - Stone Church at Chesley	13.40	13.40	13.40	.05
4662020029	New Traffic Signal - Bernie Custis Secondary School Crosswalk - Cannon at Melrose Ave	13.40	13.40	13.40	.05

OPERATING IMPACTS OF CAPITAL (2022 AND PRIOR)

	FCS20101		UPDATED		FTE
	(\$ 000's)	FTE's	Annualized	2022	
			(\$ 000's)		
<u>2020 impacts (from 2019 Capital) Deferred to 2021:</u>					
Roads, Bridges, Sidewalks, Traffic					
4661920921 New Traffic Signal - Waterdown Rd/Mill St @ Mountain	30.0	.20	-	-	-
<u>2019 impacts (from 2018 Capital) Deferred to 2020 - FURTHER deferred to 2021:</u>					
West Harbour & Waterfront Strategic Initiatives					
4411606104 Pier 7 Commercial Village	139.2	1.26	139.2	139.2	1.26
4411806201 Central Park Redevelopment	51.0	0.66	51.0	51.0	0.66
<u>2017 Impacts (from 2016 Capital) Deferred to 2018:</u>					
Recreation Facilities					
7101654609 Greensville Recreation Centre/School	53.0	0.0	0.0	0.0	0.0
<u>2016 Impacts (from 2015 Capital) Deferred to 2017:</u>					
Roads					
4041520510 Traffic Management System - Lincoln Alexander Parkway	90.0	1.00	0.0	0.0	0.0
<u>2015 Impacts (from 2014 Capital) Deferred to 2016:</u>					
Roads					
4041420110 Traffic Management System - Lincoln Alexander Parkway	160.0	2.00	0.0	0.0	0.0
Total Deferred from Previous Years	887.0	7.1	351.8	351.8	3.2
GRAND TOTAL	7,392.9	85.9	3,273.2	3,372.2	13.3

HAMILTON ENTERTAINMENT FACILITIES

2022 Preliminary Tax Supported Operating Budget

BY DIVISION

	2021	2021	2021	2022	2022	2022 Preliminary Budget vs. 2021 Restated	
	Restated Gross	Restated Net	Projected Actual Net	Preliminary Budget Gross	Preliminary Budget Net	Change \$	Change %
Hamilton Entertainment Facilities	4,402,950	4,037,180	5,373,640	4,578,480	4,187,710	150,530	3.7%
Total Hamilton Entertainment Facilities	4,402,950	4,037,180	5,373,640	4,578,480	4,187,710	150,530	3.7%

BY COST CATEGORY

	2021	2021	2022	2022 Preliminary Budget vs. 2021 Restated	
	Restated Budget	Projected Actual	Preliminary Budget	Change \$	Change %
BUILDING & GROUND	2,020,940	2,042,910	2,058,260	37,320	1.8%
CONTRACTUAL	1,467,000	2,164,720	1,467,000	0	0.0%
RESERVES/RECOVERIES	915,010	887,460	1,053,220	138,210	15.1%
TOTAL EXPENSES	4,402,950	5,095,090	4,578,480	175,530	4.0%
FEES & GENERAL	(365,770)	278,550	(390,770)	(25,000)	(6.8)%
TOTAL REVENUES	(365,770)	278,550	(390,770)	(25,000)	(6.8)%
NET LEVY	4,037,180	5,373,640	4,187,710	150,530	3.7%

CAPITAL FINANCING

2022 Preliminary Tax Supported Operating Budget

BY DIVISION

	2021	2021	2021	2022	2022	2022 Preliminary Budget vs. 2021 Restated	
	Restated Gross	Restated Net	Projected Actual Net	Preliminary Budget Gross	Preliminary Budget Net	Change \$	Change %
Debt-Healthy & Safe Communities	5,712,040	3,546,160	3,029,000	5,491,550	2,309,070	(1,237,090)	(34.9)%
Debt-Infrastructure Renewal Levy	13,428,870	13,428,870	13,429,000	13,428,870	13,428,870	0	0.0%
Debt-Corporate Financials	89,959,980	89,959,980	86,657,000	92,884,930	92,884,930	2,924,950	3.3%
Debt-Planning & Economic Development	1,624,470	1,563,290	26,000	1,229,970	1,168,790	(394,500)	(25.2)%
Debt-Public Works	38,876,010	31,043,560	26,372,000	43,640,650	35,896,650	4,853,090	15.6%
Total City Depts Capital Financing	149,601,370	139,541,860	129,513,000	156,675,970	145,688,310	6,146,450	4.4%
Boards & Agencies							
Debt - Library	447,770	166,280	0	447,493	166,000	(280)	-0.2%
Debt - Police	1,477,080	1,234,790	296,000	1,713,000	1,269,000	34,210	2.8%
Total City Depts Capital Financing	151,526,220	140,942,930	129,809,000	158,836,463	147,123,310	6,180,380	4.4%

BY COST CATEGORY

	2021	2021	2022	2022 Preliminary Budget vs. 2021 Restated	
	Restated Budget	Projected Actual	Preliminary Budget	Change \$	Change %
RESERVES/RECOVERIES	13,428,870	13,428,870	15,990,400	2,561,530	19.1%
CAPITAL FINANCING	138,097,350	126,681,930	142,846,060	4,748,710	3.4%
TOTAL EXPENSES	151,526,220	140,110,800	158,836,460	7,310,240	4.8%
GRANTS & SUBSIDIES	(408,000)	(408,000)	(408,000)	0	0.0%
RESERVES	(10,175,290)	(9,893,800)	(11,305,150)	(1,129,860)	11.1%
TOTAL REVENUES	(10,583,290)	(10,301,800)	(11,713,150)	(1,129,860)	10.7%
NET LEVY	140,942,930	129,809,000	147,123,310	6,180,380	4.4%

LIBRARY

2022 Preliminary Tax Supported Operating Budget

BY DIVISION

	2021	2021	2021	2022	2022	2022 Preliminary Budget vs. 2021 Restated	
	Restated Gross	Restated Net	Projected Actual Net	Preliminary Budget Gross	Preliminary Budget Net	Change \$	Change %
Digital Technology & Creation	4,324,690	4,128,390	4,128,390	4,816,210	4,619,910	491,520	11.9%
Human Resources & Information Services	2,557,310	2,479,310	2,479,310	2,655,130	2,577,130	97,820	3.9%
Collections & Program Development	5,191,990	4,818,540	4,818,540	5,266,890	4,880,440	61,900	1.3%
Finance & Facilities	3,215,170	3,215,170	3,215,170	3,274,480	3,274,480	59,310	1.8%
Library Administration	834,620	834,620	836,680	837,930	837,930	3,310	0.4%
Library System	4,402,710	3,419,250	3,419,250	4,285,220	3,145,760	(273,490)	(8.0)%
Public Service - Branches	13,150,190	13,132,710	13,132,710	13,366,550	13,346,370	213,660	1.6%
Total Hamilton Public Library	33,676,680	32,027,990	32,030,050	34,502,410	32,682,020	654,030	2.0%

BY COST CATEGORY

	2021	2021	2022	2022 Preliminary Budget vs. 2021 Restated	
	Restated Budget	Projected Actual	Preliminary Budget	Change \$	Change %
EMPLOYEE RELATED COST	22,502,530	22,502,530	23,071,440	568,910	2.5%
MATERIAL & SUPPLY	3,751,280	3,751,280	3,751,280	0	0.0%
VEHICLE EXPENSES	101,360	101,360	108,540	7,180	7.1%
BUILDING & GROUND	2,553,660	2,553,660	2,604,130	50,470	2.0%
CONTRACTUAL	1,672,710	1,672,710	1,696,770	24,060	1.4%
RESERVES/RECOVERIES	2,485,410	2,485,410	2,495,190	9,780	0.4%
COST ALLOCATIONS	234,310	236,370	399,640	165,330	70.6%
FINANCIAL	375,420	375,420	375,420	0	0.0%
TOTAL EXPENSES	33,676,680	33,678,740	34,502,410	825,730	2.5%
FEES & GENERAL	(382,240)	(382,240)	(380,940)	1,300	0.3%
GRANTS & SUBSIDIES	(1,266,450)	(1,266,450)	(1,279,450)	(13,000)	(1.0)%
RESERVES	0	0	(160,000)	(160,000)	(100.0)%
TOTAL REVENUES	(1,648,690)	(1,648,690)	(1,820,390)	(171,700)	(10.4)%
NET LEVY	32,027,990	32,030,050	32,682,020	654,030	2.0%

2022 Preliminary Tax Supported Operating Budget

BY DIVISION

	2021	2021	2021	2022	2022	2022 Preliminary Budget vs. 2021 Restated	
	Restated Gross	Restated Net	Projected Actual Net	Preliminary Budget Gross	Preliminary Budget Net	Change \$	Change %
Conservation Authorities	8,459,770	8,459,770	8,459,770	8,627,130	8,627,130	167,360	2.0%
Other Boards & Agencies	8,569,810	7,873,710	7,930,960	8,579,090	8,016,590	142,880	1.8%
Total Boards & Agencies	17,029,580	16,333,480	16,390,730	17,206,220	16,643,720	310,240	1.9%

BY COST CATEGORY

	2021	2021	2022	2022 Preliminary Budget vs. 2021 Restated	
	Restated Budget	Projected Actual	Preliminary Budget	Change \$	Change %
EMPLOYEE RELATED COST	325,440	263,960	339,800	14,360	4.4%
MATERIAL & SUPPLY	16,040	17,610	21,040	5,000	31.2%
BUILDING & GROUND	165,760	203,940	195,110	29,350	17.7%
CONSULTING	0	0	3,000	3,000	0.0%
CONTRACTUAL	7,061,930	7,059,130	7,058,190	(3,740)	(0.1)%
AGENCIES & SUPPORT PAYMENTS	9,081,960	9,081,960	9,263,600	181,640	2.0%
RESERVES/RECOVERIES	276,900	274,890	259,790	(17,110)	(6.2)%
COST ALLOCATIONS	86,100	121,750	50,240	(35,860)	(41.6)%
FINANCIAL	10,450	9,780	10,450	0	0.0%
CAPITAL EXPENDITURES	5,000	2,920	5,000	0	0.0%
TOTAL EXPENSES	17,029,580	17,035,940	17,206,220	176,640	1.0%
FEES & GENERAL	(666,100)	(615,210)	(562,500)	103,600	(15.6)%
GRANTS & SUBSIDIES	(30,000)	(30,000)	0	30,000	(100.0)%
TOTAL REVENUES	(696,100)	(645,210)	(562,500)	133,600	(19.2)%
NET LEVY	16,333,480	16,390,730	16,643,720	310,240	1.9%

CITY ENRICHMENT FUND

2022 Preliminary Tax Supported Operating Budget

BY DIVISION

	2021	2021	2021	2022	2022	2022 Preliminary Budget vs. 2021 Restated	
	Restated Gross	Restated Net	Projected Actual Net	Preliminary Budget Gross	Preliminary Budget Net	Change \$	Change %
Administration CEF	50,000	50,000	50,000	50,000	50,000	0	0.0%
Agriculture	143,360	143,360	143,360	143,360	143,360	0	0.0%
Arts	2,770,540	2,770,540	2,770,540	2,770,540	2,770,540	0	0.0%
Culture & Heritage	567,700	567,700	567,700	567,700	567,700	0	0.0%
Community Services	2,164,360	2,164,360	2,164,360	2,164,360	2,164,360	0	0.0%
Environment	146,390	146,390	146,390	146,390	146,390	0	0.0%
Sports & Active Lifestyles	245,990	245,990	245,990	245,990	245,990	0	0.0%
Total City Enrichment Fund	6,088,340	6,088,340	6,088,340	6,088,340	6,088,340	0	0.0%

BY COST CATEGORY

	2021	2021	2022	2022 Preliminary Budget vs. 2021 Restated	
	Restated Budget	Projected Actual	Preliminary Budget	Change \$	Change %
MATERIAL & SUPPLY	50,000	50,000	50,000	0	0.0%
AGENCIES & SUPPORT PAYMENTS	6,038,340	6,038,340	6,038,340	0	0.0%
TOTAL EXPENSES	6,088,340	6,088,340	6,088,340	0	0.0%
NET LEVY	6,088,340	6,088,340	6,088,340	0	0.0%

NON PROGRAM REVENUES

2022 Preliminary Tax Supported Operating Budget

BY DIVISION

	2021	2021	2021	2022	2022	2022 Preliminary Budget vs. 2021 Restated	
	Restated Gross	Restated Net	Projected Actual Net	Preliminary Budget Gross	Preliminary Budget Net	Change \$	Change %
Payment In Lieu	500,000	(16,399,700)	(16,399,700)	400,000	(17,108,440)	(708,740)	4.3%
Penalties and Interest	0	(11,000,000)	(11,000,000)	0	(11,400,000)	(400,000)	3.6%
Right of Way	0	(3,227,000)	(3,227,000)	0	(3,228,880)	(1,880)	0.1%
Senior Tax Credit	635,000	537,000	537,000	609,000	529,830	(7,170)	(1.3)%
Supplementary Taxes	100,000	(9,925,000)	(9,925,000)	70,000	(10,130,000)	(205,000)	2.1%
Tax Remissions and Write Offs	9,570,000	9,570,000	9,570,000	9,750,000	9,750,000	180,000	1.9%
Hydro Dividend and Other Interest	9,562,120	(5,281,480)	(5,281,480)	9,562,120	(5,281,480)	0	0.0%
Investment Income	0	(4,100,000)	(4,100,000)	0	(4,100,000)	0	0.0%
Slot Revenues	0	(5,200,000)	(5,200,000)	0	(5,200,000)	0	0.0%
POA Revenues	0	(2,365,770)	(4,736,430)	0	(2,302,220)	63,550	(2.7)%
Total NON PROGRAM REVENUES	20,367,120	(47,391,950)	(49,762,610)	20,391,120	(48,471,190)	(1,079,240)	2.3%

BY COST CATEGORY

	2021	2021	2022	2022 Preliminary Budget vs. 2021 Restated	
	Restated Budget	Projected Actual	Preliminary Budget	Change \$	Change %
CONTRACTUAL	159,180	159,180	159,180	0	0.0%
RESERVES/RECOVERIES	4,102,940	4,102,940	4,102,940	0	0.0%
FINANCIAL	10,805,000	10,805,000	10,829,000	24,000	0.2%
CAPITAL FINANCING	5,300,000	5,300,000	5,300,000	0	0.0%
TOTAL EXPENSES	20,367,120	20,367,120	20,391,120	24,000	0.1%
FEES & GENERAL	(35,563,870)	(37,934,530)	(34,281,490)	1,282,380	3.6%
TAX & RATES	(30,151,700)	(30,151,700)	(30,937,320)	(785,620)	(2.6)%
GRANTS & SUBSIDIES	(1,043,500)	(1,043,500)	(1,043,500)	0	0.0%
RESERVES	(1,000,000)	(1,000,000)	(2,600,000)	(1,600,000)	(160.0)%
TOTAL REVENUES	(67,759,070)	(70,129,730)	(68,862,310)	(1,103,240)	(1.6)%
NET LEVY	(47,391,950)	(49,762,610)	(48,471,190)	(1,079,240)	(2.3)%

**2022
Preliminary
Tax Supported
Operating
Budget Council
Referred Items**

COUNCIL REFERRED ITEMS SUMMARY

SUMMARY

FORM #	DIVISION	SERVICE / PROGRAM	DESCRIPTION OF REFERRED ITEM	2022 IMPACT		FTE Impact
				\$ GROSS	\$ NET	
Public Works						
CRI-01	Environmental Services	Forestry	City-Wide Private Tree Giveaway	\$ 45,000	\$ 45,000	0.00
Public Works SUBTOTAL				\$ 45,000	\$ 45,000	0.00
CORPORATE SERVICES						
CRI-02	Information Technology	Information Technology	Canada Healthy Communities Initiative Intake Two (FCS21020(a)) - The Public Space and Park Wi-Fi Connectivity Project	\$ 30,000	\$ 30,000	0.00
CRI-03	City Clerk's Office	Election Services	2022 Municipal Election: Communication Plan (FCS21071)	\$ 14,000	\$ 14,000	0.00
CRI-04	City Clerk's Office	Election Services	City Clerk's Vote by Mail	\$ 31,300	\$ 31,300	0.00
CORPORATE SERVICES SUBTOTAL				\$ 75,300	\$ 75,300	0.00
City Manager						
CRI-05	Digital and Innovation Office	Community Engagement	Transitioning CityLAB from pilot to permanent program	\$ 141,300	\$ 36,900	2.00
City Manager SUBTOTAL				\$ 141,300	\$ 36,900	2.00
TOTAL				\$ 261,600	\$ 157,200	2.00

CITY OF HAMILTON
2022 OPERATING BUDGET COUNCIL REFERRED ITEM

COUNCIL REFERRED ITEM CRI #: 1

OVERVIEW	
Request Title	City-Wide Private Tree Giveaway
Department	Public Works - Tax
Division	Environmental Services
Service	Forestry
Proposed Start Date	1-Jan-22
Strategic Plan Priorities	Clean and Green

2020 OPERATING BUDGET FINANCIAL IMPACTS		
DESCRIPTION	2022 AMOUNT	ANNUALIZED AMOUNT
Total Expenditures	45,000	45,000
Total Revenue	0	0
Net Levy	45,000	45,000
Full Time Equivalent (FTE)	0.00	0.00
	2022 Capital Funding	Total Capital Funding
Capital Budget Impact	0	0

COUNCIL REFERRED ITEM CRI #: 1

BACKGROUND

On August 13, 2021, Council Approved Report PW21044:

(a) That staff be directed to plan and execute a City Wide Private Tree Giveaway Program for the remainder of 2021 and on an annual basis from 2022 and beyond, subject to the approval of the following:

- (i) That \$15,000 be allocated from the 2021 Forestry tax operating budget to fund the 2021 Fall Private Tree Giveaway Program; and,
- (ii) That the 2022 Private Tree Giveaway Program annual operating budget request of \$45,000 be referred to the 2022 tax operating budget process for consideration.

In 2021, successful Ward specific Private Tree Giveaways were executed by staff for Wards 2, 3, 5, 6, 7, and 8. Overall, 756 trees were requested and delivered. This Program was positively received by residents of participating Wards and significant interest was received from other Wards. Additional trees were requested from residents in other Wards who did not have a Ward specific Tree Giveaway Program in place. As a result, it is being recommended that a permanent program be created.

DESCRIPTION

This request is to provide funding for the procurement and distribution of 3,000 trees to City of Hamilton residents. The CioH Corporate Climate Change Task Force and the draft Urban Forest Strategy have both identified tree planting as a key action to aid in the efforts of offsetting the City’s carbon footprint and many other environmental and social benefits. The current urban tree canopy coverage for the City is 21.2%, with a draft future target of 30%. Significant increases in tree planting are critical in meeting the 30% tree canopy coverage target. Based on the success of the Ward specific programs, it is recommended that this be implemented City Wide as a core service.

CITY OF HAMILTON
2022 OPERATING BUDGET COUNCIL REFERRED ITEM

COUNCIL REFERRED ITEM CRI #: 2

OVERVIEW	
Request Title	Canada Healthy Communities Initiative Intake Two (FCS21020(a)) -The Public Space and Park Wi-Fi Connectivity Project
Department	Corporate Services
Division	Information Technology
Service	Information Technology
Proposed Start Date	1-Jan-22
Strategic Plan Priorities	Built Environment and Infrastructure

2020 OPERATING BUDGET FINANCIAL IMPACTS		
DESCRIPTION	2022 AMOUNT	ANNUALIZED AMOUNT
Total Expenditures	30,000	30,000
Total Revenue	0	0
Net Levy	30,000	30,000
Full Time Equivalent (FTE)	0.00	0.00
	2022 Capital Funding	Total Capital Funding
Capital Budget Impact	0	0

COUNCIL REFERRED ITEM CRI #: 2

BACKGROUND

The Public Space and Park Wi-Fi Connectivity Project, with a total project cost of up to \$250K, would involve the installation of Wi-Fi in public spaces across the city. Potential locations include the City Hall Courtyard, Bus Terminals, as well as, City parks possibly with a focus on areas in Code Red Neighbourhoods and lower income Census tracts.

There is possibility of potential partnerships with the Hamilton Public Library (HPL) and the Boards of Education on this initiative as several schools have existing connectivity and, in many cases, are adjacent to parks. Complexity increases with additional partners. However, the likelihood of successful outcomes is enhanced.

It is estimated that the cost of a Wi-Fi connection per park would be approximately \$10 to \$15 K (excludes future operating costs). The scope of target parks and public spaces has not been completed. There may also be the opportunity to include smart benches that could be deployed in the City’s Business Improvement Areas (BIAs) to improve connectivity. Smart benches are urban furniture that use solar energy to power environmental sensors and to provide free device charging for citizens. Project scope development contemplates assessing various factors to ensure the greatest benefit for the community is realized given the amount of the potential CHCI grant.

DESCRIPTION

Provide Wi-Fi within public spaces and parks within the City

CITY OF HAMILTON
2022 OPERATING BUDGET COUNCIL REFERRED ITEM

COUNCIL REFERRED ITEM CRI #: 3

OVERVIEW	
Request Title	2022 Municipal Election: Communication Plan (FCS21071)
Department	Corporate Services
Division	City Clerk's Office
Service	Election Services
Proposed Start Date	1-Jan-22
Strategic Plan Priorities	

2020 OPERATING BUDGET FINANCIAL IMPACTS		
DESCRIPTION	2022 AMOUNT	ANNUALIZED AMOUNT
Total Expenditures	14,000	14,000
Total Revenue	0	0
Net Levy	14,000	14,000
Full Time Equivalent (FTE)	0.00	0.00
	2022 Capital Funding	Total Capital Funding
Capital Budget Impact	0	0

COUNCIL REFERRED ITEM CRI #: 3

BACKGROUND

2022 Municipal Election: Communication Plan (FCS21071) (City Wide) (Item 10.7)
(b) That an annual increase of \$14,000 for the Election Expense Reserve (112206), to cover the increased costs to deliver an enhanced communications strategy regarding Municipal Elections for the City of Hamilton, be referred to the 2022 Operating Budget (GIC) deliberations for consideration;

DESCRIPTION

An annual increase of \$14,000 for the Election Expense Reserve (112206) to cover enhanced communications

CITY OF HAMILTON
2022 OPERATING BUDGET COUNCIL REFERRED ITEM

COUNCIL REFERRED ITEM CRI #: 4

OVERVIEW	
Request Title	City Clerk's Vote by Mail
Department	Corporate Services
Division	City Clerk's Office
Service	Election Services
Proposed Start Date	1-Jan-22
Strategic Plan Priorities	Community Engagement and Participation

2020 OPERATING BUDGET FINANCIAL IMPACTS		
DESCRIPTION	2022 AMOUNT	ANNUALIZED AMOUNT
Total Expenditures	31,300	31,300
Total Revenue	0	0
Net Levy	31,300	31,300
Full Time Equivalent (FTE)	0.00	0.00
	2022 Capital Funding	Total Capital Funding
Capital Budget Impact	0	0

COUNCIL REFERRED ITEM CRI #: 4

BACKGROUND

Governance Review Sub-Committee Report 21-005 - July 14, 2021 (Item 10.2)
(iii) That the annual contribution to the Election Expense Reserve (112206) be increased by \$31,250 to cover the increased costs to deliver a special vote-by-mail for future municipal elections, be referred to the 2022 Operating Budget deliberations for consideration.

DESCRIPTION

Increasing the annual contribution to the Election Expense Reserve (112206) be increased by \$31,250

CITY OF HAMILTON
2022 OPERATING BUDGET COUNCIL REFERRED ITEM

COUNCIL REFERRED ITEM CRI #: 5

OVERVIEW	
Request Title	Transitioning CityLAB from pilot to permanent program
Department	City Manager
Division	Digital and Innovation Office
Service	Community Engagement
Proposed Start Date	1-Jun-22
Strategic Plan Priorities	Community Engagement and Participation

2020 OPERATING BUDGET FINANCIAL IMPACTS		
DESCRIPTION	2022 AMOUNT	ANNUALIZED AMOUNT
Total Expenditures	141,300	241,000
Total Revenue	(104,400)	(178,000)
Net Levy	36,900	63,000
Full Time Equivalent (FTE)	2.00	2.00
	2022 Capital Funding	Total Capital Funding
Capital Budget Impact	0	0

COUNCIL REFERRED ITEM CRI #: 5

BACKGROUND

CityLAB is an innovation hub that brings together student, academic, and civic leaders to co-create a better Hamilton for all. This partnership between McMaster University, Mohawk College, Redeemer University, and the City of Hamilton matches students and faculty with City staff to develop innovative solutions to city-identified projects that align with the City’s Strategic and Term of Council Priorities. CityLAB began as a 3 year pilot project in 2017. In 2019, the academic partners and the City extended CityLAB’s Program and Licence Agreement until May 31, 2022. Staff are recommending that the program move from a pilot to a regularly funded, fully-operational program.

DESCRIPTION

Transitioning CityLAB Hamilton from a pilot project funded by the Tax Stabilization Reserve to a regularly funded program through the general levy.

**2022
Preliminary
Tax Supported
Operating Budget
Business Cases**

BUSINESS CASES SUMMARY

FORM #	DIVISION	SERVICE / PROGRAM	DESCRIPTION	2022 IMPACT		FTE Impact
				\$ GROSS	\$ NET	
PLANNING & ECONOMIC DEVELOPMENT						
BC-01	Tourism & Culture	Citizen and Customer Service	Film Production Facilitation	\$ 77,720	\$ -	1.00
BC-02	Growth Management	Citizen and Customer Service	Infrastructure Planning Project Manager - in support of PW/EcDev/Corporate storm water management initiatives	\$ 101,000	\$ -	1.00
PLANNING & ECONOMIC DEVELOPMENT SUBTOTAL				\$ 178,720	\$ -	2.00
HEALTHY AND SAFE COMMUNITIES						
BC-03	Hamilton Paramedic Service	Hamilton Paramedic Service	Hamilton Paramedic Service 2022-2025 Enhancement (Ambulance)	\$ 1,082,000	\$ 541,000	10.00
BC-04	Public Health Services	Healthy Families	OSDCP Service Delivery	\$ -	\$ -	0.80
HEALTHY AND SAFE COMMUNITIES SUBTOTAL				\$ 1,082,000	\$ 541,000	10.80

BUSINESS CASES SUMMARY

FORM #	DIVISION	SERVICE / PROGRAM	DESCRIPTION	2022 IMPACT		FTE Impact
				\$ GROSS	\$ NET	
CORPORATE SERVICES						
BC-05	Customer Service, POA and Fin'l Integration	Provincial Offences Administration	POA Virtual Court	\$ 604,900	\$ -	8.00
BC-06	Financial Planning, Admin & Policy	Financial Management	Development Finance Analysis and Support	\$ 70,700	\$ 70,700	1.00
BC-07	Information Technology	Information Technology	Additional FTEs for Information Technology	\$ 183,100	\$ 183,100	2.00
BC-08	Information Technology	Information Technology	Additional FTE for Senior Contract Specialist	\$ 82,900	\$ 82,900	1.00
BC-09	Information Technology	Information Technology	IT Security FTE	\$ 115,300	\$ 115,300	1.00
BC-10	Information Technology	Information Technology	Strategy & Architecture FTEs	\$ 86,600	\$ 86,600	1.00
BC-11	Legal Services and Risk Management	Legal Services	Administrative Assistant to City Solicitor	\$ 72,000	\$ 72,000	1.00
CORPORATE SERVICES SUBTOTAL				\$ 1,215,500	\$ 610,600	15.00
TOTAL				\$ 2,476,220	\$ 1,151,600	27.80

CITY OF HAMILTON
2022 OPERATING BUDGET BUSINESS CASES

BUSINESS CASE BC #: 1

BUSINESS CASE OVERVIEW	
Request Title	Film Production Facilitation
Department	Planning & Economic Development
Division	Tourism & Culture
Service	Citizen and Customer Service
Proposed Start Date	1-Apr-22
Strategic Plan Priorities	Economic Prosperity and Growth

2022 OPERATING BUDGET FINANCIAL IMPACTS		
DESCRIPTION	2022 AMOUNT	ANNUALIZED AMOUNT
Total Expenditures	77,720	99,300
Total Revenue	(77,720)	(99,300)
Net Levy	0	0
Full Time Equivalent (FTE)	1.00	1.00
	2022 Capital Funding	0.0
Capital Budget Impact	\$0	\$0

BUSINESS CASE BC #: 1

BACKGROUND

Film and television production in Hamilton has increased exponentially since 2018, bringing in direct spending in the community of over \$50M annually. Hamilton is one of Ontario's busiest areas for filming, attracts prestige foreign and domestic productions, and was recently recognized at the international level with a nomination for "Outstanding Film Commission" at the 2021 Location Manager's Guild International awards.

The combination of increased filming activity as well as targeted efforts by staff to maximize revenue opportunities has led to increased City revenues year over year, with fee and rental revenues climbing from a \$203,836 in 2017 to a YTD total of \$921,180 in 2021.

In addition to these positive impacts, increased filming also leads to the growth of local brick and mortar businesses that support the industry, including studio investment.

The Film Office (Tourism and Culture Division) contributes to this growth by providing a one-stop shop for productions filming in Hamilton, including coordination of all City services, site rentals, and permits. This has become increasingly challenging in recent years as the volume and complexity of filming requests continue to increase. In order to keep pace with the demand and continue to foster growth, the Film Office must be adequately resourced.

DESCRIPTION

The addition of 1 permanent FTE (Business Development Officer – Film) will allow the film office meet the demand for film permits and continue to grow opportunities for City revenue and spending in the local economy. The additional position will be funded through film-related revenues and will have zero net levy impact.

The role of the Business Development Officer – Film is to facilitate film and television production in Hamilton. Business Development Officers (BDOs) work with productions to match them with locations and local businesses that support their needs, liaise with community stakeholders to minimize negative impacts, coordinate all necessary City permissions and issue film permits, and manage any issues that arise during filming.

CITY OF HAMILTON
2022 OPERATING BUDGET BUSINESS CASES

BUSINESS CASE BC #: 2

BUSINESS CASE OVERVIEW	
Request Title	Infrastructure Planning Project Manager - in support of PW/ EcDev/Corporate storm water management initiatives
Department	Planning & Economic Development
Division	Growth Management
Service	Citizen and Customer Service
Proposed Start Date	1-Apr-22
Strategic Plan Priorities	Built Environment and Infrastructure

2022 OPERATING BUDGET FINANCIAL IMPACTS		
DESCRIPTION	2022 AMOUNT	ANNUALIZED AMOUNT
Total Expenditures	101,000	134,000
Total Revenue	(101,000)	(134,000)
Net Levy	0	0
Full Time Equivalent (FTE)	1.00	1.00
Capital Budget Impact	0	0
	2022 Capital Funding	Total Capital Funding

BUSINESS CASE BC #: 2

BACKGROUND

The Infrastructure Planning (IP) SWM team is a group of 3 water resource specialists (1 SPM and 2PMs). Current activity levels in this group leave no redundancy when dealing with typical staff absences (sickness, maternity leaves, and vacation). Driven in part by the increasing interest in stormwater and climate change issues across the corporation, this team is experiencing a significant increase in workloads affecting service levels.

Increased activity levels have, and will, result from: realignment of the Development Engineering team to improve approval efficiencies, expediting the employment strategy, changing legislation, and participation in cross department initiatives concerning stormwater matters and climate change (flooding, LIDs, master planning, and regulatory compliance).

DESCRIPTION

New PM to address emerging resourcing issues:

1. DevEng restructure to improve service levels adds pressure to IP SWM team
2. In 2022, staff to process SWM ECAs per Cons.Lin.Infras. ECA -more tech review required
3. IP SWM staff has increasing role in the following:
 - UBEs (eg GRIDs, UWS)
 - Facilitating SWSs/MDPs/Block Servicing
 - Updating SWSs/MDPs and address site constraints
 - SWM review with aggressive deadlines to expedite employment initiative
 - Growth policy/criteria instituted internally / provincially (e.g. MECP/EA/CA Act changes),
 - New policies/documents for OPs/SPs/NPs, Participating in PW initiatives (FDMSS & W/WW/SWM
 - MPs

CITY OF HAMILTON
2022 OPERATING BUDGET BUSINESS CASES

BUSINESS CASE BC #: 3

BUSINESS CASE OVERVIEW	
Request Title	Hamilton Paramedic Service 2022-2025 Enhancement (Ambulance)
Department	Healthy and Safe Communities
Division	Hamilton Paramedic Service
Service	Hamilton Paramedic Service
Proposed Start Date	1-Apr-22
Strategic Plan Priorities	Healthy and Safe Communities

2022 OPERATING BUDGET FINANCIAL IMPACTS		
DESCRIPTION	2022 AMOUNT	ANNUALIZED AMOUNT
Total Expenditures	1,082,000	1,436,060
Total Revenue	(541,000)	(718,030)
Net Levy	541,000	718,030
Full Time Equivalent (FTE)	10.00	10.00
Capital Budget Impact	2022 Capital Funding 340,790	Total Capital Funding 340,790

BUSINESS CASE BC #: 3

BACKGROUND

As identified in the 2017, 2018, 2019 and 2020 Annual Reports (HSC18020, HSC19035, HSC20021, HSC21018) the Service continues to experience service demand growth at a rate greater than overall population growth. While 2020 saw a slight decline due to the early COVID period the growth in demand in 2021 has resumed at a higher than average rate. We anticipate continued growth in demand of 4%, an average of 12 responses per day, thus necessitating this service capacity enhancement.

The strategy to mitigate the adverse impact of increased call demand is to increase resources at a level commensurate with the increase in demand. While the impact of COVID is expected to decrease in 2022 we will have to continue with enhanced safety precautions including additional call preparation and cleaning activity. Additional pressure from the return and escalation of long hospital offload delays is anticipated to continue as the Hamilton area hospitals continue to be faced with significant patient flow and capacity challenges. With the addition of the historical daily response increase of 12 per day combined with increases in the average time it takes to complete a call additional resources are required to meet the demand while maintaining current levels of performance.

DESCRIPTION

We are requesting one additional ambulance with ancillary equipment and 10 additional FTE's to provide emergency response 24 hours per day, 7 days per week. Provincial funding according to the current Provincial funding methodologies will cover approximately 50% of the operating expenses in Year 2 (2023) of the enhancement. With approval, additional one-time capital funding of an ambulance and ancillary equipment is required amounting to \$340,790 in gross costs to be funded from Development Charge Reserves (\$306,710) and the Unallocated Capital Levy Reserve (\$34,080).

CITY OF HAMILTON
2022 OPERATING BUDGET BUSINESS CASES

BUSINESS CASE BC #: 4

BUSINESS CASE OVERVIEW	
Request Title	OSDCP Service Delivery
Department	Healthy and Safe Communities
Division	Public Health Services
Service	Healthy Families
Proposed Start Date	1-Apr-22
Strategic Plan Priorities	Healthy and Safe Communities

2022 OPERATING BUDGET FINANCIAL IMPACTS		
DESCRIPTION	2022 AMOUNT	ANNUALIZED AMOUNT
Total Expenditures	0	0
Total Revenue	0	0
Net Levy	0	0
Full Time Equivalent (FTE)	0.80	0.80
	2022 Capital Funding	Total Capital Funding
Capital Budget Impact	0	0

BUSINESS CASE BC #: 4

BACKGROUND

The Ontario Seniors Dental Care Program (OSDCP) is a 100% Ministry funded program that provides dental care for eligible low-income seniors. Denturist and dental specialist services are covered services under the OSDCP schedule of services.

We have been unsuccessful in establishing service level agreements with dental specialists (e.g. oral surgeon, endodontist, periodontist, prosthodontist) to provide services outside of our Public Health Dental Clinic (PHDC). We would be reengaging dental specialists so they will provide their services at our PHDC. Our staff would be responsible for booking and confirming client appointments, reprocessing instruments, invoicing for services, turnover of the room and providing clinical support. The dental specialists would attend the clinic for the day to provide services to OSDCP clients and be reimbursed for their time spent. We are reducing the amount of staff time needed in the dental specialists' office and increasing the amount of staff time needed at our PHDC. The OSDCP has also greatly increased the workload for our Dental Clinic reception staff. The volume of OSDCP related calls and the extra time required to support these OSDCP clients is much greater than initially anticipated. An increase in receptionist fte is required in order for us to manage the work resulting from the implementation of the OSDCP.

DESCRIPTION

Request is to Redistribute funding within the 100% Ministry funded Ontario Seniors Dental Care Program (OSDCP) budget to support an increase in 0.8 permanent FTE (0.4 dental receptionist and 0.4 CDA). As this is a redistribution within a 100% Ministry funded program there is no levy impact. A 0.4 FTE dental receptionist is required to support the increased volume of work at the PHDC reception resulting from the OSDCP. The 0.4 FTE CDA is needed to support in-house dental specialist appointments at the PHDC. We will decrease the amount previously assigned to specialist services and increase the staffing funds to support the new approach we are taking to secure specialist services in-house.

CITY OF HAMILTON 2022 OPERATING BUDGET BUSINESS CASES

BUSINESS CASE BC #: 5

BUSINESS CASE OVERVIEW	
Request Title	POA Virtual Court
Department	Corporate Services
Division	Customer Service, POA and Fin'l Integration
Service	Provincial Offences Administration
Proposed Start Date	1-Apr-22
Strategic Plan Priorities	Healthy and Safe Communities

2022 OPERATING BUDGET FINANCIAL IMPACTS		
DESCRIPTION	2022 AMOUNT	ANNUALIZED AMOUNT
Total Expenditures	604,900	802,804
Total Revenue	(604,900)	(802,804)
Net Levy	0	0
Full Time Equivalent (FTE)	8.00	8.00
	2022 Capital Funding	Total Capital Funding
Capital Budget Impact	0	0

BUSINESS CASE BC #: 5

BACKGROUND

The pandemic has resulted in the Ministry of the Attorney General (MAG) directing that all Provincial courts implement the introduction of virtual early resolution meetings and trials. Early resolution refers to a designated court date created to allow a defendant and a prosecutor in a provincial offence case to meet and attempt to resolve their case. In April 2021, Regional Senior Justice of the Peace provided her approval for Hamilton POA to begin setting virtual trials to commence in the fall. Supporting the implementation of virtual trials, the City of Hamilton will require 2 court reporters that will provide support in the moderation and management of the virtual trial and early resolution processes as well as 1 administrative clerk to support the processing of court information from paper to electronic as well as support the management of increased court filings.

Similarly, POA Legal will require 3 prosecutors that will support the implementation of both early resolution meetings and virtual trials as well as 2 administrative assistant that will provide support in the preparation of electronic early resolution and trial documentation. With court operations being suspended for over a year, and the introduction of additional provincial and municipal charges, there is a significant case volume that requires management in order to ensure cases can be heard within the required period. Without the above resources, the ability to effectively support the implementation of virtual early resolution and trials will be heavily constrained.

DESCRIPTION

Ministry of the Attorney General (MAG) has directed all Provincial courts to implementation of virtual early resolution meetings and trials due to the Pandemic

CITY OF HAMILTON
2022 OPERATING BUDGET BUSINESS CASES

BUSINESS CASE BC #: 6

BUSINESS CASE OVERVIEW	
Request Title	Development Finance Analysis and Support
Department	Corporate Services
Division	Financial Planning, Admin & Policy
Service	Financial Management
Proposed Start Date	1-Apr-22
Strategic Plan Priorities	Our People and Performance

2022 OPERATING BUDGET FINANCIAL IMPACTS		
DESCRIPTION	2022 AMOUNT	ANNUALIZED AMOUNT
Total Expenditures	70,700	93,777
Total Revenue	0	0
Net Levy	70,700	70,700
Full Time Equivalent (FTE)	1.00	1.00
	2022 Capital Funding	Total Capital Funding
Capital Budget Impact	0	0

BUSINESS CASE BC #: 6

BACKGROUND

A 2019 Report, prepared by BMA Consulting, recommended “that the City consider the hiring of a Senior Financial Analyst to potentially reduce the cost of outside consultants in the preparation of the DC Background Study and the CBC Study subject to additional clarity once the new regulations are enacted” The legislative changes that have since occurred have significantly increased the volume and complexity of rules that municipalities must adhere to. In addition there has been a significant increase in development activity in the City over the last number of years increasing the volume of DC estimates, and related analysis and tracking

DESCRIPTION

Prior to the 2019 DC Background Study, a full time temporary FTE was hired for up to 24 months. With the legislated changes, a full time temporary Senior Financial Analyst was subsequently hired. This proposal converts the temporary FTE to a permanent FTE. There is no NET impact as this position is being funded from Capital projects.

CITY OF HAMILTON 2022 OPERATING BUDGET BUSINESS CASES

BUSINESS CASE BC #: 7

BUSINESS CASE OVERVIEW	
Request Title	Additional FTEs for Information Technology
Department	Corporate Services
Division	Information Technology
Service	Information Technology
Proposed Start Date	1-Apr-22
Strategic Plan Priorities	Our People and Performance

2022 OPERATING BUDGET FINANCIAL IMPACTS		
DESCRIPTION	2022 AMOUNT	ANNUALIZED AMOUNT
Total Expenditures	183,100	243,000
Total Revenue	0	0
Net Levy	183,100	243,000
Full Time Equivalent (FTE)	2.00	2.00
	2022 Capital Funding	Total Capital Funding
Capital Budget Impact	0	0

BUSINESS CASE BC #: 7

BACKGROUND

The IT division engaged an independent consultant to review and make recommendations required to:

- ensure stability of the city's use of technology and applications
- ensure the stability of underlying software, hardware and network infrastructure
- review our processes and resources for vendor and financial management including providing consideration for contractual complexities especially with cloud deployment
- conduct a review of our security policies, processes and resources to ensure we continue to protect ourselves from cyber security violations
- review our future skillsets of IT professionals focusing on cloud deployment
- Review of our IT disciplines and processes identifying any gaps.

DESCRIPTION

Six additional FTEs are required at a total annual operating cost of \$728,000, to be phased in as follows:

2021 – 2 FTEs, \$243,000
2022 – 2 FTEs, \$243,000
2023 – 2 FTEs, \$242,000

CITY OF HAMILTON
2022 OPERATING BUDGET BUSINESS CASES

BUSINESS CASE BC #: 8

BUSINESS CASE OVERVIEW	
Request Title	Additional FTE for Senior Contract Specialist
Department	Corporate Services
Division	Information Technology
Service	Information Technology
Proposed Start Date	1-Apr-22
Strategic Plan Priorities	Built Environment and Infrastructure

2022 OPERATING BUDGET FINANCIAL IMPACTS		
DESCRIPTION	2022 AMOUNT	ANNUALIZED AMOUNT
Total Expenditures	82,900	110,000
Total Revenue	0	0
Net Levy	82,900	110,000
Full Time Equivalent (FTE)	1.00	1.00
	2022 Capital Funding	Total Capital Funding
Capital Budget Impact	0	0

BUSINESS CASE BC #: 8

BACKGROUND

Senior Contract Specialist is required in order to manage technology related contracts made with vendors and partners as well as internal city agreements between IT and business lines city wide. To ensure alignment with IT Security Policies, contractual obligations, and IT operational requirements and capabilities.

To provide expert support and guidance for the development, management and administration of contracts for spending on technology services and products across the City's divisions.

DESCRIPTION

One additional FTE is required at a total annual operating cost of \$110,000.

CITY OF HAMILTON
2022 OPERATING BUDGET BUSINESS CASES

BUSINESS CASE BC #: 9

BUSINESS CASE OVERVIEW	
Request Title	IT Security FTE
Department	Corporate Services
Division	Information Technology
Service	Information Technology
Proposed Start Date	1-Apr-22
Strategic Plan Priorities	Our People and Performance

2022 OPERATING BUDGET FINANCIAL IMPACTS		
DESCRIPTION	2022 AMOUNT	ANNUALIZED AMOUNT
Total Expenditures	115,300	153,000
Total Revenue	0	0
Net Levy	115,300	153,000
Full Time Equivalent (FTE)	1.00	1.00
	2022 Capital Funding	Total Capital Funding
Capital Budget Impact	0	0

BUSINESS CASE BC #: 9

BACKGROUND

The Supervisor, IT Security and Risk Management position will work with Manager, IT Security in order to meet the information security requirements in alignment with IT Security Policies, contractual obligations, legislations (MFIPPA and PHIPA) and industry standards (PCI DSS, NIST CSF).

This position will help develop information security risk assessment methodology for technology related projects and initiatives.

The IT Security Team is committed to implement recommendations of Cybersecurity Audit, PCI DSS Review project and existing contractual obligations and aligning with known security frameworks and standards.

This position is required to position the team for success and work with Manager, IT Security on building cybersecurity culture, manage security risks and adopting “security by design” methodology.

DESCRIPTION

One additional FTE is required at a total annual operating cost of \$153,000.

CITY OF HAMILTON
2022 OPERATING BUDGET BUSINESS CASES

BUSINESS CASE BC #: 10

BUSINESS CASE OVERVIEW	
Request Title	Strategy & Architecture FTEs
Department	Corporate Services
Division	Information Technology
Service	Information Technology
Proposed Start Date	1-Apr-22
Strategic Plan Priorities	Our People and Performance

2022 OPERATING BUDGET FINANCIAL IMPACTS		
DESCRIPTION	2022 AMOUNT	ANNUALIZED AMOUNT
Total Expenditures	86,600	115,000
Total Revenue	0	0
Net Levy	86,600	115,000
Full Time Equivalent (FTE)	1.00	1.00
	2022 Capital Funding	Total Capital Funding
Capital Budget Impact	0	0

BUSINESS CASE BC #: 10

BACKGROUND

The changing Information Technology landscape has shown a dramatic shift to Cloud based software architecture and business solution implementations. In order for the Information Technology division to meet business demand and support the evolving Cloud landscape we need new roles experienced in Cloud base technologies to support project and operational work from the business.

DESCRIPTION

The Information Technology (IT) division requires two additional FTEs in 2022 in order to fulfill the new skills required for Cloud Enablement and increasing demand of workload on IT Staff.

2022 – 1 FTEs:

1 – Cloud Architect: \$115,000

Responsibilities: Design and implement Cloud based architectures to support business demand.

CITY OF HAMILTON 2022 OPERATING BUDGET BUSINESS CASES

BUSINESS CASE BC #: 11

BUSINESS CASE OVERVIEW	
Request Title	Administrative Assistant to City Solicitor
Department	Corporate Services
Division	Legal Services and Risk Management
Service	Legal Services
Proposed Start Date	1-Apr-22
Strategic Plan Priorities	Our People and Performance

2022 OPERATING BUDGET FINANCIAL IMPACTS		
DESCRIPTION	2022 AMOUNT	ANNUALIZED AMOUNT
Total Expenditures	72,000	95,600
Total Revenue	0	0
Net Levy	72,000	95,600
Full Time Equivalent (FTE)	1.00	1.00
	2022 Capital Funding	Total Capital Funding
Capital Budget Impact	0	0

BUSINESS CASE BC #: 11

BACKGROUND

Currently, the Administrative Assistant (AA) to the City Solicitor is a temporary position established in 2020 through an EOI. Prior to this, there was no dedicated AA; the City Solicitor was supported by multiple Legal Assistants (who also supported other Solicitors), resulting in individuals with minimal capacity to provide basic administrative duties (ex. coordinating calendar of appointments, setting up meetings, handling email, preparation of documentation/Committee & Council reports).

In addition, when the temporary Administrative Assistant was created it was graded at a pay grade level 2, which was in line with Legal Assistants. However, the role of Administrative Assistant has considerably higher level of complex duties which include the coordination of the overall administration services of the Legal & Risk Management Services Division and involvement in implementing strategic initiatives. The job description is currently under review/revision and will be under going a job evaluation through Human Resources with the intent of increasing the pay grade to level 3.

DESCRIPTION

Permanent AA is required to support the following:

- Dedicated AA allows for consistent/efficient delivery of duties, greater accountability, decreased risk exposure in having fewer individual's privy to confidential City information
- Increase productivity of City Solicitor. Admin tasks will be delegated to the AA allowing for City Solicitor to focus on critical tasks/decisions impacting the City
- Expansion of duties: AA is responsible for overall admin. services of the div. and involved in implementing strategic initiatives
- Provide extra level of customer service to City staff, Council, external counsel/agencies, etc. AA is the main point of contact to ensure timely communication between all parties

**2022
Preliminary
Tax Supported
Operating Budget
Multi-Year
Budget Outlook**

MULTI-YEAR OUTLOOK

	2023		2024		2025	
	\$	%	\$	%	\$	%
	Change 2023 vs 2022		Change 2024 vs 2023		Change 2025 vs 2024	
PLANNING & ECONOMIC DEVELOPMENT						
General Manager	1,083,540	2.7%	1,106,520	2.1%	1,125,140	1.7%
Transportation, Planning & Parking	2,151,490	(3.8)%	2,152,290	0.0%	2,210,090	2.7%
Building	645,080	6.2%	668,070	3.6%	697,370	4.4%
Economic Development	5,824,690	2.8%	5,960,180	2.3%	6,076,660	2.0%
Growth Management	593,820	28.1%	676,390	13.9%	736,310	8.9%
Licensing & By-Law Services	7,201,880	3.7%	7,418,990	3.0%	7,638,470	3.0%
Planning	4,478,780	4.1%	4,607,910	2.9%	4,688,730	1.8%
Tourism & Culture	9,940,550	2.4%	10,097,430	1.6%	10,250,550	1.5%
TOTAL PLANNING & ECONOMIC DEVELOPMENT	31,919,830	3.0%	32,687,780	2.4%	33,423,320	2.3%
HEALTHY & SAFE COMMUNITIES						
HSC Administration	3,567,520	(0.6)%	3,674,340	3.0%	3,766,810	2.5%
Children's Services & Neighbourhood Dev.	12,121,770	15.6%	12,354,430	1.9%	12,573,290	1.8%
Ontario Works	13,446,470	4.7%	14,012,040	4.2%	14,560,500	3.9%
Housing Services	56,832,580	5.4%	59,711,490	5.1%	63,267,860	6.0%
Long Term Care	11,675,820	(0.8)%	12,539,890	7.4%	13,284,700	5.9%
Recreation	36,382,710	1.1%	36,796,270	1.1%	37,321,850	1.4%
Hamilton Fire Department	100,436,130	3.0%	103,564,410	3.1%	106,850,450	3.2%
Hamilton Paramedic Service	29,006,670	2.2%	29,704,000	2.4%	30,444,390	2.5%
Public Health Services	17,528,130	22.2%	18,431,130	5.2%	19,327,510	4.9%
TOTAL HEALTHY & SAFE COMMUNITIES	280,997,800	4.5%	290,788,000	3.5%	301,397,360	3.6%

MULTI-YEAR OUTLOOK

	2023		2024		2025	
	\$	%	\$	%	\$	%
	Change 2023 vs 2022		Change 2024 vs 2023		Change 2025 vs 2024	
PUBLIC WORKS						
PW-General Administration	678,380	3.0%	696,120	2.6%	711,660	2.2%
Energy Fleet & Facilities	14,485,690	1.5%	14,634,330	1.0%	14,727,860	0.6%
Engineering Services	0	0.0%	0	0.0%	0	0.0%
Environmental Services	46,473,640	2.0%	47,295,320	1.8%	48,073,400	1.6%
Transit	93,682,440	6.5%	100,912,540	7.7%	108,809,480	7.8%
Transportation Operations & Maintenance	88,836,070	5.5%	90,112,380	1.4%	91,351,840	1.4%
Waste Management	48,500,590	3.3%	50,268,210	3.6%	52,002,390	3.4%
TOTAL PUBLIC WORKS	292,656,810	4.6%	303,918,900	3.8%	315,676,630	3.9%
LEGISLATIVE						
Legislative General	(365,210)	0.9%	(368,690)	1.0%	(362,560)	(1.7)%
Mayors Office	1,235,830	2.0%	1,258,260	1.8%	1,278,570	1.6%
Volunteer Committee	120,650	0.0%	120,650	0.0%	120,650	0.0%
Ward Budgets	4,397,740	1.9%	4,474,380	1.7%	4,546,010	1.6%
TOTAL LEGISLATIVE	5,389,010	2.0%	5,484,600	1.8%	5,582,670	1.8%
CITY MANAGER						
Office of the City Auditor	1,229,040	2.3%	1,254,370	2.1%	1,276,480	1.8%
CMO - Admin	243,810	4.4%	252,810	3.7%	262,760	3.9%
Communication & Strategic Initiatives	2,587,490	2.8%	2,651,960	2.5%	2,710,340	2.2%
Digital & Innovation Office	217,790	5.6%	228,000	4.7%	237,440	4.1%
Government & Community Relations	884,650	1.9%	899,330	1.7%	911,950	1.4%
Human Resources	8,776,670	2.2%	8,941,120	1.9%	9,094,610	1.7%
TOTAL CITY MANAGER	13,939,450	2.4%	14,227,590	2.1%	14,493,580	1.9%

MULTI-YEAR OUTLOOK

	2023		2024		2025					
	Change 2023 vs 2022		Change 2024 vs 2023		Change 2025 vs 2024					
	\$	%	\$	%	\$	%				
CORPORATE SERVICES										
City Clerk's Office	3,236,490		68,060	2.1%	3,312,620	76,130	2.4%	3,383,960	71,340	2.2%
Customer Service, POA and Fin'l Integration	6,122,340		162,700	2.7%	6,260,330	137,990	2.3%	6,384,540	124,210	2.0%
Financial Serv, Taxation & Corp Controller	4,419,730		134,740	3.1%	4,529,810	110,080	2.5%	4,637,100	107,290	2.4%
Legal Services & Risk Management	4,087,620		148,040	3.8%	4,193,640	106,020	2.6%	4,267,300	73,660	1.8%
Corporate Services - Administration	340,310		8,570	2.6%	346,830	6,520	1.9%	351,640	4,810	1.4%
Financial Planning, Admin & Policy	5,611,080		239,780	4.5%	5,763,740	152,660	2.7%	5,943,850	180,110	3.1%
Information Technology	15,785,440		459,760	3.0%	16,005,400	219,960	1.4%	16,182,180	176,780	1.1%
TOTAL CORPORATE SERVICES	39,603,010		1,221,650	3.2%	40,412,370	809,360	2.0%	41,150,570	738,200	1.8%
CORPORATE FINANCIALS - EXPENDITURES										
Corporate Initiatives	7,476,250		(163,520)	(2.1)%	7,484,240	7,990	0.1%	6,929,950	(554,290)	(7.4)%
Corporate Pensions, Benefits & Contingency	18,385,000		2,599,610	16.5%	19,034,200	649,200	3.5%	19,736,560	702,360	3.7%
TOTAL CORPORATE FINANCIALS - EXPENDITURES	25,861,250		2,436,090	10.4%	26,518,440	657,190	2.5%	26,666,510	148,070	0.6%
HAMILTON ENTERTAINMENT FACILITIES										
Operating	0		(4,187,710)	(100.0)%	0	0	0.0%	0	0	0.0%
TOTAL HAMILTON ENTERTAINMENT FACILITIES	0		(4,187,710)	(100.0)%	0	0	0.0%	0	0	0.0%
TOTAL CITY EXPENDITURES	690,367,160		25,953,900	3.6%	714,037,680	23,670,520	3.4%	738,390,640	24,352,960	3.4%

MULTI-YEAR OUTLOOK

	2023		2024		2025		
	Change 2023 vs 2022		Change 2024 vs 2023		Change 2025 vs 2024		
	\$	%	\$	%	\$	%	
CAPITAL FINANCING							
Debt-Healthy & Safe Communities	2,309,070	0	0	0.0%	2,309,070	0	0.0%
Debt-Infrastructure Renewal Levy	13,428,870	0	0	0.0%	13,428,870	0	0.0%
Debt-Corporate Financials	98,355,930	5,471,000	6,629,000	5.9%	109,838,930	4,854,000	4.6%
Debt-Planning & Economic Development	1,168,790	0	0	0.0%	1,168,790	0	0.0%
Debt-Public Works	35,896,650	0	0	0.0%	35,896,650	0	0.0%
TOTAL CAPITAL FINANCING	151,159,310	5,471,000	6,629,000	3.8%	162,642,310	4,854,000	3.1%
BOARDS & AGENCIES							
Police Services							
Operating	182,461,650	3,577,679	3,649,233	2.0%	189,833,100	3,722,218	2.0%
Capital Financing	1,234,790	(34,210)	0	(2.7)%	1,234,790	0	0.0%
Total Police Services	183,696,440	3,543,469	3,649,233	2.0%	191,067,890	3,722,218	2.0%
Other Boards & Agencies							
Library	33,963,950	1,281,930	894,010	3.9%	35,695,310	841,350	2.4%
Conservation Authorities	8,797,840	170,710	174,120	2.0%	9,149,560	177,600	2.0%
MPAC	7,119,260	139,590	142,390	2.0%	7,406,880	145,230	2.0%
Hamilton Beach Rescue Unit	136,890	2,690	2,730	2.0%	142,420	2,800	2.0%
Royal Botanical Gardens	673,570	13,210	13,470	2.0%	700,780	13,740	2.0%
Farmers Market	261,110	18,750	14,130	7.7%	286,530	11,290	4.1%
Total Other Boards & Agencies	50,952,620	1,626,880	1,240,850	3.3%	53,385,480	1,192,010	2.3%

MULTI-YEAR OUTLOOK

	2023		2024		2025	
	Change 2023 vs 2022		Change 2024 vs 2023		Change 2025 vs 2024	
	\$	%	\$	%	\$	%
Capital Financing - Other Boards & Agencies	166,000	0.0%	166,000	0.0%	166,000	0.0%
City Enrichment Fund	6,088,340	0.0%	6,088,340	0.0%	6,088,340	0.0%
TOTAL BOARDS & AGENCIES	240,903,400	2.2%	245,793,483	2.0%	250,707,710	2.0%

TOTAL EXPENDITURES	1,082,429,870	36,595,249	1,117,619,473	35,189,603	1,151,740,660	34,121,188	3.1%
NON PROGRAM REVENUES							
Payment In Lieu	(17,108,440)	0.0%	(17,108,440)	0.0%	(17,108,440)	0.0%	
Penalties and Interest	(11,400,000)	0.0%	(11,400,000)	0.0%	(11,400,000)	0.0%	
Right of Way	(3,228,880)	0.0%	(3,228,880)	0.0%	(3,228,880)	0.0%	
Senior Tax Credit	529,830	0.0%	529,830	0.0%	529,830	0.0%	
Supplementary Taxes	(10,130,000)	0.0%	(10,130,000)	0.0%	(10,130,000)	0.0%	
Tax Remissions and Write Offs	9,750,000	0.0%	9,750,000	0.0%	9,750,000	0.0%	
Hydro Dividend and Other Interest	(5,281,480)	0.0%	(5,281,480)	0.0%	(5,281,480)	0.0%	
Investment Income	(4,100,000)	0.0%	(4,100,000)	0.0%	(4,100,000)	0.0%	
Slot Revenues	(5,200,000)	0.0%	(5,200,000)	0.0%	(5,200,000)	0.0%	
POA Revenues	(2,234,320)	67,900	(2,171,040)	63,280	(2,103,970)	67,070	
TOTAL NON PROGRAM REVENUES	(48,403,290)	67,900	(48,340,010)	63,280	(48,272,940)	67,070	(0.1)%

TOTAL LEVY REQUIREMENT	1,034,026,580	36,663,149	1,069,279,463	35,252,883	1,103,467,720	34,188,258	3.2%
-------------------------------	----------------------	-------------------	----------------------	-------------------	----------------------	-------------------	-------------

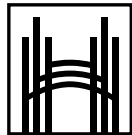

Hamilton